

# Raumausstatter Dekokatalog **D.8**

ERNST DIEKGRAEFE GmbH & Co.  
Altenaer Straße 13  
D-58762 Altena-Dahle  
Telefon (02352) 7001-0  
Telefax (02352) 7001-99  
www.ed-altena.de  
info@ed-altena.de



ERNST DIEKGRAEFE



Gardinen- und  
Dekozubehör



ERNST DIEKGRAEFE

ERNST DIEKGRAEFE GmbH & Co.  
Altenaer Str. 13  
58762 Altena

Telefon 02352 / 7001-0  
FAX 02352 / 7001-99

verkauf@ed-altena.de  
www.ed-altena.de

## Außendienst



### Nordwest-Niedersachsen, Bremen

PLZ 21, 228 - 229, 26 - 29, 49300 - 49899

#### Uwe Sander

27751 Delmenhorst  
usander@ed-altena.de  
Mobil 0172 / 2871616



### Sachsen, Sachsen-Anhalt, Thüringen, Franken, Oberpfalz

PLZ 0, 910 - 913, 90 - 99

#### Ronald Klauer

07919 Langenbach (Vogtland)  
rklauer@ed-altena.de  
Mobil 0172 / 2871627



### Nord-Hessen, NRW, Rheinland-Pfalz

PLZ 34 - 35, 51500 - 51990, 53, 552-554, 56000 - 56299, 580 - 585, 588, 59440 - 59999, 60 - 65

#### Sebastian Balzer

35457 Lollar  
sbalzer@ed-altena.de  
Mobil 0172 / 5222156



### Baden-Württemberg, Südwest-Bayern, Vorarlberg

PLZ 70 - 73, 78, 79, 8, 914 - 918

#### Hermann Fink

89407 Dillingen a. d. Donau  
hfink@ed-altena.de  
Mobil +49(0)172 / 5222155

### Münsterland, Rhein-Ruhr, Rheinland, Niederrhein, Eifel

PLZ 40600 - 49599, 50000 - 51500, 523 - 525, 58700 - 59400

Mobil 0172 / 5222157

### Rheinland-Pfalz, Süd-Hessen, Saarland, Luxemburg

PLZ 54 - 56, 66 - 69, 74500 - 74999, 75, 76, 77

Mobil 0172 / 5222165

### Mecklenburg-Vorpommern, Nord-Brandenburg, Schleswig-Holstein, Hamburg

PLZ 16, 170 - 174, 180 - 186, 190 - 194, 235 - 239, 24, 253 - 259

Mobil 0172 / 2635683

## A

Akustik-Schaum + Stoff	D 337
Alu-Beschwerungssystem	D 364
Alu-Schienenysteme	D 307 ff, D 1 ff
Ausklinkzangen	D 328

## B

Bad-Zubehör	D 431
Befestigungen für Vitragenstangen	D 374 ff
Beschwerungssysteme	D 363 f
Biegegeräte / Service	D 328
Bildernägel	D 396
Bilderschienen	D 314 f
Bleibänder	D 413
Bleiquasten	D 413
Bodenschutzmatten	D 438 f
Brausemantelringe	D 431
Brettklemmen	D 331
Bügeleinlagen	D 408 f
Bürostuhlrollen	D 444
Bürostuhlunterlagen	D 438 f
BÜSCHE INSIDE / TECDOR	D 176 ff

## C

Café-Stangen	D 372
California (Florida) - Garnituren	D 372

## D

Deko-Klemmsysteme	D 375 ff
Deko-Ösen	D 424 ff
Dekoschnur	D 358
Deko-Seil	D 432 f
Deko-Spangen	D 386
Donauklammern	D 379
Drahtseilgarnituren	D 16 ff
Drapierhalter	D 391
Dübel	D 450 ff
Duschstangen + Zubehör	D 431
Duschvorhänge	D 431
DYNAMIC Klemmstange	D 368

## E

Edelstahl-Ösen	D 427 f
EDIX Garnituren	D 217 ff

## F

Faltenbänder	D 399 ff
Faltenfäden	D 414
Faltenleghaken	D 379
Faltenlegrollen	D 342 f, D 346
Faltenstecker	D 415, D 348
Faltensteckpistolen	D 414
Federklappdübel	D 452
Federstangen	D 431
Feststeller	D 344 f, D 347
Filzbodenschoner	D 442 f
Fitschenringe	D 441
Flachstab	D 363
Flächenvorhang-Systeme	D 316 ff
Flächenvorhang-Zubehör	D 324 ff, D 363 f
FLAT Flachösen	D 430
Flauschband	D 420 f
Florida Garnituren	D 372
Fußmatten	D 436 f

## G

Gardinenbänder	D 399 ff
Gardinenringe	D 378
Garn	D 416 f
Gewichte	D 362, D 413
Gleiter	D 340 ff, D 346 f
Gleitfix	D 345

## H

Haken zum Faltenlegen	D 340 ff, D 379
Haken zum Raffen	D 396 ff
Hakenband	D 420 f
Handlaufseile + Zubehör	D 432 f
Hohlraum-Dübel	D 450 ff
Hohlringe	D 378

## I

Innenlaufschienen	D 307 ff, D 329 ff
-------------------	--------------------

## K

Karabinerhaken	D 19, D 379, D 431
Klebehaken	D 374, D 349
Klemmstangen	D 366 ff
Klemmträger für Scheibenstangen	D 375 ff
Klettband	D 420 f
Klipp-Klapp-Klammern	D 331
Kordelgewichte	D 362
Kordeln	D 358
Kunststoffgleiter für Möbel	D 443
Kunststoff-Ösen	D 424 f

## L

LaOla Wellenband	D 400
------------------	-------

## M

Magnet-Deko	D 389 ff, D 173
Markisengarn	D 417
Maxi-Schienen	D 308 f
ME-Rohre	D 446
Messing-Ösen	D 426 ff
Messing-Rosetten	D 392 ff
Möbelgleiter	D 442 f
Möbellenkrollen + Füße	D 444 f
Möbeluntersetzer	D 443

## N

Nadeln	D 415, D 348
Nägel	D 396, D 447
Nähgarn	D 416 f
Nahtband	D 408
Niroseil	D 19
Nylonschnur	D 358

## O

Objektschienen	D 316 f, D 320
Ösen	D 424 ff
Ösenbänder	D 429
Ösengleitringe	D 429

## P

Parsunda Wellenband	D 399
Perlonkordeln	D 358
PE-Rohre	D 364
Pilzstab	D 326
PINN Gardinenstangen	D 370
Plissee-Träger	D 375
PRESTO Gardinenstangen	D 369
Profile / Aluminium	D 307 ff

## Q

Quasten / Raff	D 388
Quasten / Schleuder	D 383

## R

Raffbügel	D 391
Raff-Deko	D 386 ff
Raffhaken	D 396 ff
Raffhaltereinlage	D 408 f
Raffquasten	D 388
Raffrollo Zubehör	D 358 ff
Raffrosetten	D 392 ff
Raffvorhang-Systeme	D 351 ff
Reißverschluss	D 418 f
Rigipsdübel	D 454
Ringklammern	D 19, D 378
Ringschrauben	D 360
Rollen für Alu- und SM-Schienen	D 342 f
Rollen für Möbel	D 444 f
Rollo-Beschwerungssysteme	D 363 f
Rollo-Zubehör	D 358 ff
Rosetten	D 392 ff

## S

SB-Zubehör	D 346 ff
Segeltuchösen	D 426 ff
Seil + Zubehör	D 432 f
Seilspann-Garnituren	D 16 ff
Silikon-Spray	D 345
SM-Schienen + Zubehör	D 330 f
Spangen	D 386 f
Spannfix	D 366 f
Spann-Vitragenstangen	D 366 ff
Spanplattenschrauben	D 455 ff

## SCH

Schabrackeneinlagen	D 408 f
Schalrosetten	D 392 ff
Scheibenstangen	D 366 ff
Schlaufengleiter	D 410, D 346
Schleuderschiene	D 314 f
Schleuderstäbe und Quasten	D 380 ff
Schleuderwagen	D 341, D 343
Schmutzfangmatten	D 436 f
Schnurführer	D 360 f
Schnurquasten	D 362
Schnurspanner	D 360
Schnurwickler	D 360 f
Schnurzug-System	D 322, D 333, D 345
Schrägband	D 412
Schrauben	D 455 ff
Schrauben-Doktor	D 457
Schwenkstange	D 22 f
Schwerstegschiene + Zubehör	D 335

## ST

Stecknadeln	D 415, D 348
Stilgarnituren	D 1 – D 306
Stockschrauben	D 393
Stuhlbeinnägel	D 442 f
Stuhlwinkel	D 331

## T

T-Schienen + Zubehör	D 332
Teppichnägel	D 447
Tischdeckenunterlage	D 412
Tischtuchklammern	D 349
Torxschrauben	D 457
Treppenläuferstangen	D 446, D 448
Treppenseil + Zubehör	D 432 f
Treppenstangenösen	D 447, D 449
Türfeststeller	D 441
Türpuffer	D 440 f
Türstopper	D 440 f
Twist Raffhalter	D 387
Twist-It Biegehalter	D 391

## U

U-Schienen + Zubehör	D 333 f
----------------------	---------

## V

Verstärkungsbänder	D 429
VION	D 180 ff
Vitragenstangen	D 366 ff
Vlieseline	D 408 f
Vorhanggarnituren	D 1 – D 306
Vorhangschienen / Aluminium	D 307 ff

## W

Wäschenetz	D 425
Wandbespannung	D 336
Watte-Keder	D 409
Wellenbänder für Schienen und Stangen	D 399 ff
Wendeschiene	D 316 f
Winkelleisen	D 331
Wolffries-Vorhangstoff	D 338

## Z

Zierhaken	D 397 ff
Zierhalter	D 390
Zinkband	D 413
Zwischenfeststeller	D 344, D 347

## Wichtige Hinweise

Bei Versand von Sperrgut und Gefahrgut (lösungsmittelhaltige Klebstoffe) erfolgt die Lieferung per Spedition »ab Werk«.

Warenrücknahmen erfolgen nur nach ausdrücklicher Genehmigung durch uns unter Angabe von Rechnungsdatum und Rechnungsnummer.

Die Rücksendung ist in jedem Falle frei Haus vorzunehmen. Bei unfreier Rücksendung wird die Annahme durch uns grundsätzlich verweigert.



Internet:  
www.ed-altena.de  
E-Mail:  
info@ed-altena.de

Telefon (02352) 7001-0  
Telefax (02352) 7001-99  
Altenaer Straße 13  
D-58762 Altena-Dahle

Absender:

ERNST DIEKGRAEFE GmbH & Co.  
Altenaer Str. 13

D-58762 Altena

**Telefax: +49 (0)2352 / 7001 99**

**E-Mail: verkauf@ed-altena.de**

Wir bestellen die nachstehend aufgeführten Waren zu den uns bekannten, am Ende des Kataloges und auf unserer Internetseite dargestellten allgemeinen Lieferbedingungen.

Datum

Stempel und Unterschrift des Auftraggebers

Kundennummer

Kommission

Liefertermin

--	--	--

Zusatzangaben:

Bestellnummer	Artikelbezeichnung	Menge	Preis in €/St. netto



Lastschrift

**ERNST DIEKGRAEFE**



Internet:  
www.ed-altena.de  
E-Mail:  
info@ed-altena.de

Telefon (02352) 7001-0  
Telefax (02352) 7001-99  
Altenaer Straße 13  
D-58762 Altena-Dahle

Ernst Diekgraefe GmbH & Co.  
Altenaer Str. 13

58762 Altena-Dahle

Wir nehmen Ihnen eine Last ab – mit der  
**SEPA Basislastschrift!**

Sehr geehrte ED-Kundin, sehr geehrter ED-Kunde,

Sie kennen das sicher, jede Rechnung, die Sie erhalten, ist auch immer ein Vorgang, der per Überweisung bezahlt werden muss.

Diesen Arbeitsaufwand möchten wir Ihnen ersparen!

Wenn Sie uns eine Lastschriftermächtigung erteilen, buchen wir die fälligen Rechnungsbeträge termingerecht von Ihrem Bank- oder Postbankkonto ab.

Sie brauchen nur noch Ihren Kontoauszug, in dem der Betrag und der Verwendungszweck ausgewiesen wird, auf seine Richtigkeit hin zu überprüfen.

Darüber hinaus sparen Sie nicht nur die Arbeit, sondern auch noch Geld.  
Wir gewähren Ihnen bis zu

**4 % Skonto**

auf Rechnungen, die mit dem Lastschriftverfahren beglichen werden.

Bitte fordern Sie die Formulare bei unserer Buchhaltung unter Tel.: 02352/700140 an.

Sie können das Formular auch direkt herunterladen: [www.ed-altena.de/SEPA-Basislastschrift](http://www.ed-altena.de/SEPA-Basislastschrift)



40 x 15 mm | **flat**

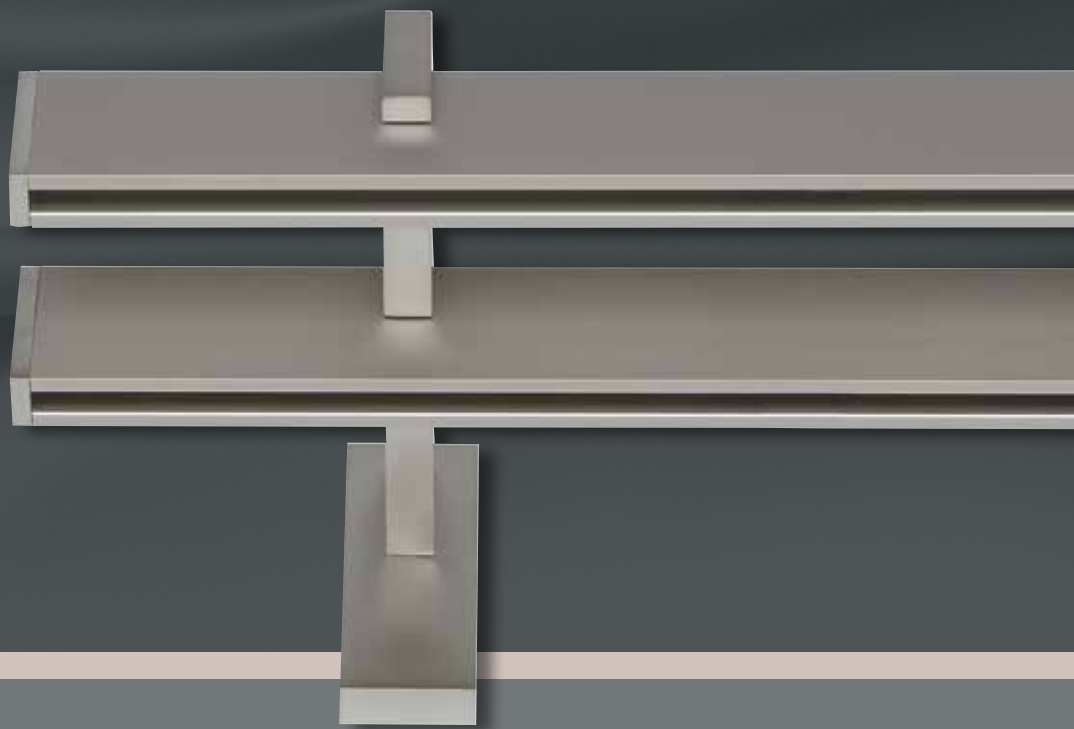



Flat 8901-97



Flatgro 8905-97



Flataus 8913-97

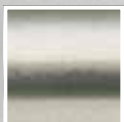

97 | satin silber



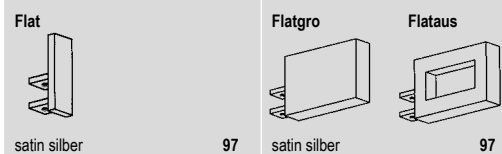

## Garnituren mit X-Gleiter

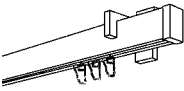
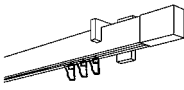
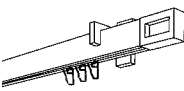
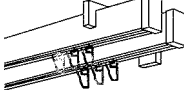
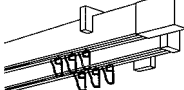
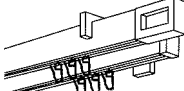

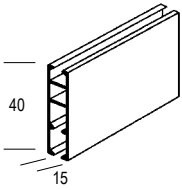
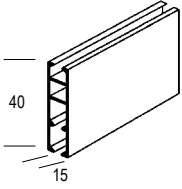
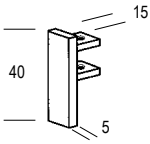
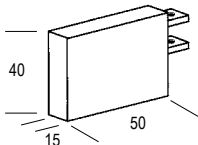
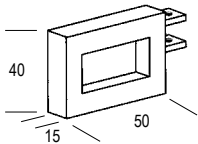
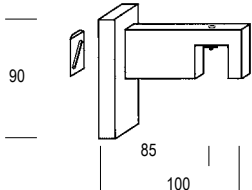
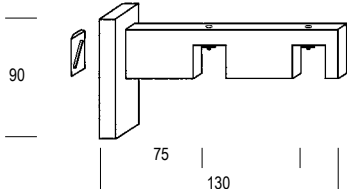
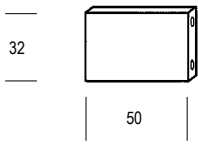
1-Lauf	Länge	X-Gleiter	Preis	Preis
 <b>8901 Flat</b>	100	16	150,-	174,-
	120	18	156,-	184,-
	140	22	164,-	189,-
	160	26	170,-	196,-
	180	28	174,-	202,-
 <b>8905 Flatgro</b>	200	32	216,-	243,-
	220	34	222,-	249,-
	240	38	229,-	254,-
	260	42	235,-	262,-
	280	44	240,-	268,-
 <b>8913 Flataus</b>	300	48	247,-	275,-
	320	50	252,-	281,-
	340	54	259,-	287,-
	360	58	265,-	294,-
	380	60	271,-	300,-
	400	64	312,-	340,-
	Preis je 20 cm			6,-
		3. Träger	ab 2,00 m	ab 2,00 m
		4. Träger	ab 4,00 m	ab 4,00 m
2-Lauf	Länge	X-Gleiter	Preis	Preis
 <b>8902 Flat</b>	100	32	223,-	240,-
	120	36	236,-	252,-
	140	44	247,-	265,-
	160	52	260,-	278,-
	180	56	272,-	288,-
 <b>8906 Flatgro</b>	200	64	327,-	341,-
	220	68	340,-	352,-
	240	76	351,-	366,-
	260	84	363,-	378,-
	280	88	375,-	390,-
 <b>8914 Flataus</b>	300	96	389,-	403,-
	320	100	399,-	414,-
	340	108	412,-	426,-
	360	116	425,-	439,-
	380	120	438,-	453,-
	400	128	491,-	503,-
	Preis je 20 cm			12,-
		3. Träger	ab 2,00 m	ab 2,00 m
		4. Träger	ab 4,00 m	ab 4,00 m

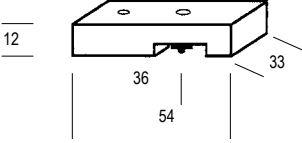
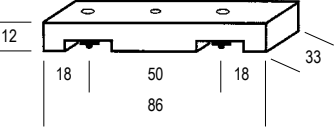
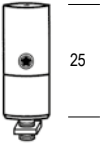
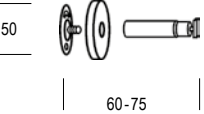
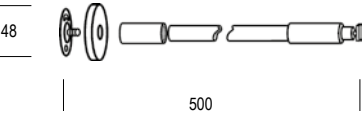
	Artikel	Oberfläche	Art.-Nr.	Preis
	<b>Flachprofil Flat</b> Aluminium 6 mm-Lauf Länge: 6 m  Längen m	satın silber	8900097	29,50
	<b>Flachprofil Flat</b> Aluminium  Zuschnitte m	satın silber	Z8900097	36,70
	<b>Endkappe Flat</b> Aluminium  Stück	satın silber	8974697	10,90
	<b>Endknopf Flatgro</b> Aluminium  Stück	satın silber	8974797	31,00
	<b>Endknopf Flataus</b> Aluminium  Stück	satın silber	8974997	31,00
	<b>Träger Flat 1-Lauf</b> Aluminium  Stück	satın silber	8974197	35,20
	<b>Träger Flat 2-Lauf</b> Aluminium  Stück	satın silber	8974297	42,40
	<b>Trägerverlängerung Flat 5 cm</b> Aluminium  Stück	satın silber	2182397	24,80

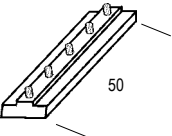
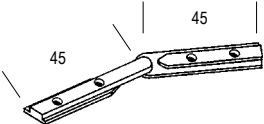
	Artikel	Oberfläche	Art.-Nr.	Preis
	<b>Deckenträger</b> Aluminium 1-Lauf	satın silber	8977197	26,40
	Stück			
	<b>Deckenträger</b> Aluminium 2-Lauf	satın silber	8977297	36,80
	Stück			
	<b>Deckenträger</b> Edelstahl 2,5 cm	edelstahl	2150450	26,70
	Stück			
	<b>Deckenträger</b> Edelstahl	edelstahl	2140050	56,10
	Stück			
	<b>Deckenträger</b> Edelstahl 50 cm kürzbar	edelstahl	164995-116	48,00
	Stück			
	<b>X-Gleiter mit Faltenhaken</b> Kunststoff für 6 mm-Lauf	alufarbig / weiß	8500010	0,20
	Stück			
	<b>Profilverbinder</b> Aluminium	alu blank	1520070	9,30
	Stück			
	<b>Eckverbinder 90°-180°</b> Aluminium	alu blank	1520371	24,00
	Stück			

	Artikel	Oberfläche	Art.-Nr.	Preis
	<b>Clic-Gleiter mit Faltenhaken</b>	weiß	2000316	0,25
	Kunststoff			
	für 6 mm-Lauf			
	Stück			

80 x 25 mm | **oval**

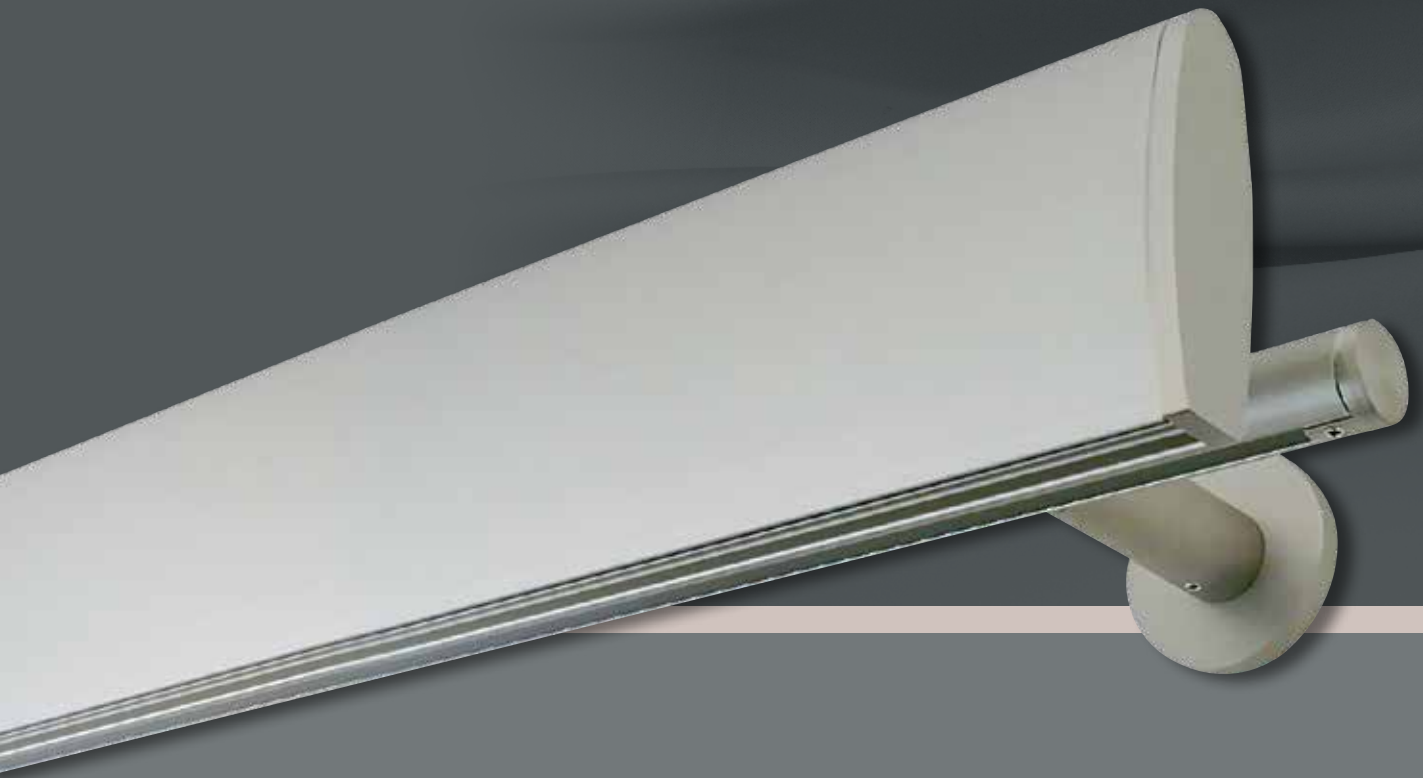

Oval 8020-20



Oval 8021-20

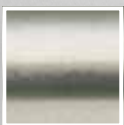
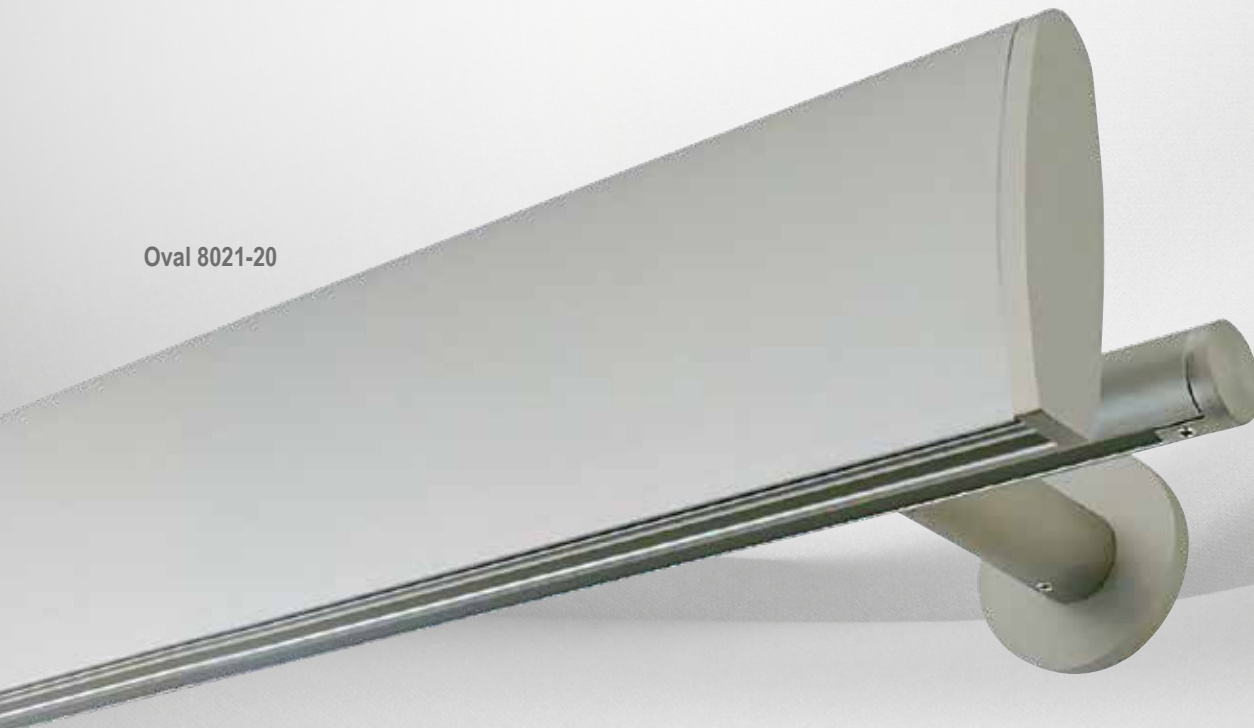



20 | satin-silber

satin silber 20



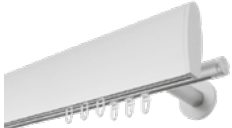

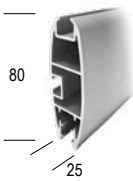
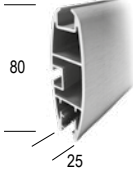
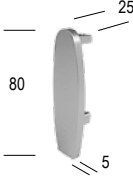
Garnituren mit X-Gleiter

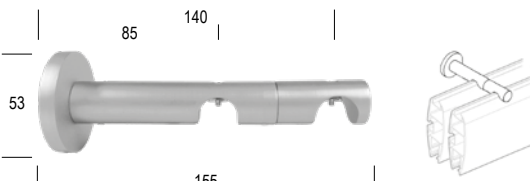
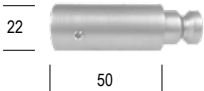
1-Lauf	Länge	X-Gleiter	Preis
 <p>8020 Oval</p>	100	16	104,-
	120	18	116,-
	140	22	128,-
	160	26	140,-
	180	28	152,-
	200	32	164,-
	220	34	176,-
	240	38	188,-
	260	42	200,-
	280	44	224,-
	300	48	236,-
	320	50	248,-
	340	54	260,-
	360	58	272,-
	380	60	284,-
	400	64	296,-
	420	68	308,-
	440	72	320,-
460	76	332,-	
480	80	344,-	
500	84	356,-	
3. Träger ab 2,60 m Preis je weitere 20 cm	12,00		

2-Lauf	Länge	X-Gleiter	Preis
 <p>8021 Oval</p>	100	32	153,-
	120	36	168,-
	140	44	183,-
	160	52	198,-
	180	56	213,-
	200	64	228,-
	220	68	243,-
	240	76	258,-
	260	84	273,-
	280	88	312,-
	300	96	327,-
	320	100	342,-
	340	108	357,-
	360	116	372,-
	380	120	387,-
	400	128	402,-
	420	136	417,-
	440	144	432,-
460	152	447,-	
480	160	462,-	
500	168	477,-	
3. Träger ab 2,60 m Preis je weitere 20 cm	15,00		

	Artikel	Oberfläche	Art.-Nr.	Preis
	<p><b>Flachprofil Oval</b> Aluminium 6mm-Lauf Länge: 6m</p> <p>Längen m</p>	satin silber	8000020	48,00
	<p><b>Flachprofil Oval</b> Aluminium 6mm-Lauf</p> <p>Zuschnitte m</p>	satin silber	Z8000020	57,60
	<p><b>Endkappe Oval</b> Aluminium</p> <p>Stück</p>	satin silber	8010020	9,50
	<p><b>Wand-/Deckenträger</b> 5,5 cm</p> <p>Stück</p>	satin silber	8010620	14,75
	<p><b>Träger Universal</b> <b>1-Lauf</b> Aluminium drehbar</p> <p>Stück</p>	satin silber	8010120	12,75
	<p><b>Träger Universal</b> <b>2-Lauf</b> drehbar</p> <p>Stück</p>	satin silber	8010220	19,75
	<p><b>Trägerverlängerung</b> <b>5 cm</b> für Träger Universal und Spezial</p> <p>Stück</p>	satin silber	8010420	5,25



	Artikel	Oberfläche	Art.-Nr.	Preis
	<b>Rundprofil 20 mm Ø</b> Aluminium 6mm-Lauf Länge: 6m  Längen m	satin silber weiß	8100020 8100044	11,25 10,15
	<b>Rundprofil 20 mm Ø</b> Aluminium 6mm-Lauf  Zuschnitte m	satin silber weiß	Z8100020 Z8100044	13,50 12,18
	<b>Endkappe 20 mm Ø</b>  Stück	satin silber weiß	8110020 8110044	4,80 4,80
	<b>X-Gleiter mit Faltenhaken</b> Kunststoff für 6mm-Lauf  Stück	alufarbig / weiß	8500010	0,20
	<b>Clic-Gleiter mit Faltenhaken</b> Kunststoff für 6mm-Lauf  Stück	weiß	2000316	0,25

2 mm | **piccolo**  
**Seilspanngarnitur**

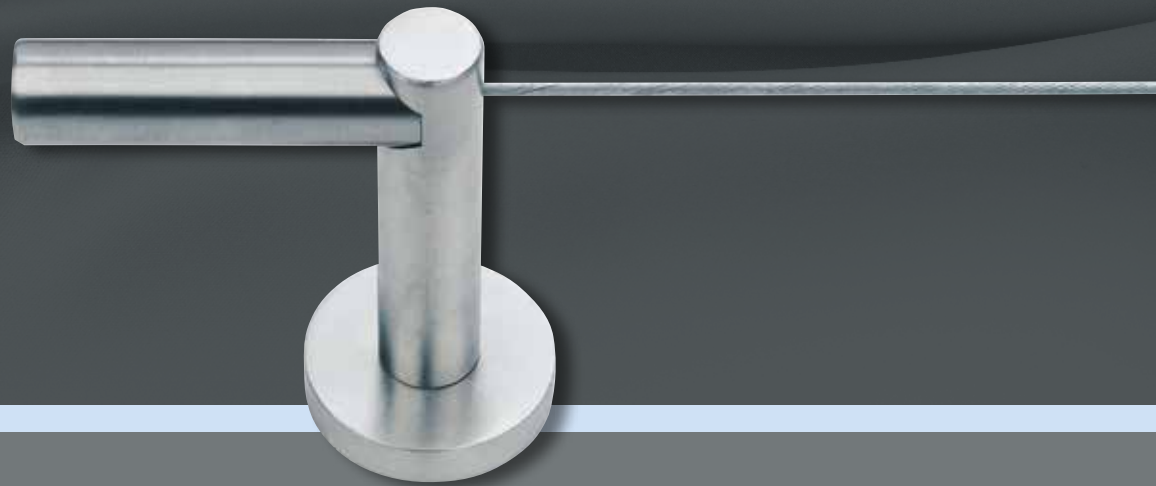



Picolo 0201-50



Mini 0202-50









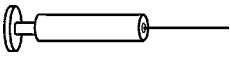

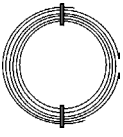
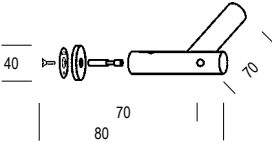
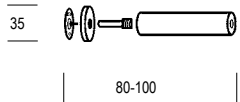
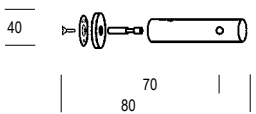

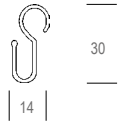
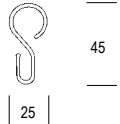



















50 | edelstahl

edelstahl 50

	Länge	Preis
 <b>0201 Picolo</b>	5 m	131,-
	10 m	142,-
	Abschlag Wandlager je Seite	18,90

	Länge	Preis
 <b>0202 Mini</b>	5 m	92,-
	10 m	103,-

	Artikel	Oberfläche	Art.-Nr.	Preis
	<b>Edelstahlseil</b> 2 mm Länge: 5 m Länge: 10 m Stück	edelstahl		
			0200050	15,80
			0200150	26,70
	<b>Träger Picolo</b> mit Spannvorrichtung Edelstahl Stück	edelstahl	0210150	57,10
	<b>Wandlager Picolo</b> mit Spannvorrichtung Edelstahl Stück	edelstahl	0210350	38,20
	<b>Mittelträger Picolo</b> Edelstahl Wandabstand: 7 cm Stück	edelstahl	0210250	33,80
	<b>Feststeller</b> Stahl Stück	vernickelt	0220550	2,20
	<b>Haken</b> Edelstahl Stück	edelstahl	0220050	0,45
	<b>Haken</b> Edelstahl Stück	edelstahl	0220307	0,60

Art.-Nr.	Artikel-Bezeichnung	VE	unverb. VK € (inkl. MwSt.)
<b>Seilspann-Garnitur »Flexo« – mit Gelenk</b> SB-verpackt, komplett mit 5 m Niroseil und Montagezubehör			
572081	Messing vernickelt	 1 Stück	3.018700 <b>42,30/St.</b>
572084	Messing nickel-matt	 1 Stück	9.018700 <b>42,30/St.</b>
<b>Seilspann-Garnitur »Livorno« – von Wand zu Wand</b> komplett mit 5 m Niroseil und Montagezubehör			
572020	nickel	 1 Stück	5.014500 <b>32,90/St.</b>
<b>Niroseil 2 mm Ø</b> rostfrei			
572051	5 m lang	 1 Stück	1.006900 <b>15,60/St.</b>
572052	10 m lang	 1 Stück	1.012100 <b>27,40/St.</b>
<b>Seilklemme</b> für Seil-Ø bis 3 mm, mit M4 Gewinde, Gesamthöhe 20 mm			
328007	verzinkt	 100 Stück 	8.041002 <b>0,95/St.</b>
<b>Klammer</b> , passend für alle Seilspann-Garnituren			
SB-verpackt à 20 Stück im Blister			
572030	nickel	 1 Blister	7.004900 <b>11,10/Bl.</b>
572034	messing	 1 Blister	9.004850 <b>11,00/Bl.</b>
130035	nickel, lose	 100 Stück 	5.018452 <b>0,42/St.</b>
130034	messing, lose	 100 Stück 	3.018452 <b>0,42/St.</b>
<b>Haken</b> , passend für alle Seilspann-Garnituren			
SB-verpackt à 20 Stück im Blister			
572031	nickel 42 mm	 1 Blister	4.003000 <b>6,80/Bl.</b>
572036	Edelstahl, lose 30 mm	 50 Stück	4.023002 <b>0,45/St.</b>
		100 Stück	1.018402
<b>Karabinerhaken</b>			
130056	20 mm vernickelt	 100 Stück 	2.010002 <b>0,23/St.</b>
130055	25 mm vernickelt	 100 Stück	1.017052 <b>0,39/St.</b>
130054	30 mm vernickelt	 100 Stück	6.018002 <b>0,42/St.</b>
130057	40 mm vernickelt	 100 Stück	4.020002 <b>0,46/St.</b>
130057-1	40 mm NiRo / V2A	 100 Stück	5.036002 <b>0,82/St.</b>
130057-2	40 mm NiRo / V2A – speziell für Duschvorhänge	 100 Stück	6.036802 <b>0,84/St.</b>
130059	60 mm vernickelt	 500 Stück	7.033402 <b>0,75/St.</b>
130058	60 mm NiRo / V2A	 100 Stück	9.099002 <b>2,25/St.</b>
<b>Ringklammern, Ø 22 mm</b>			
130030	Eisen vernickelt	 100 Stück 	6.013452 <b>0,31/St.</b>
130031	Eisen vermessingt	 100 Stück	1.013452 <b>0,31/St.</b>

12 mm | **vario**  
**Schwenkstange**

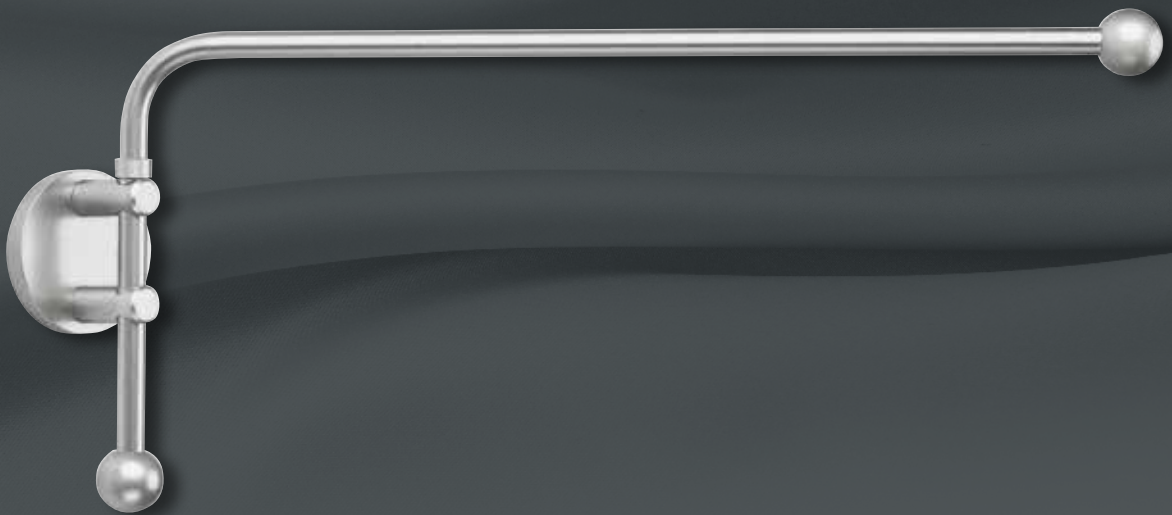

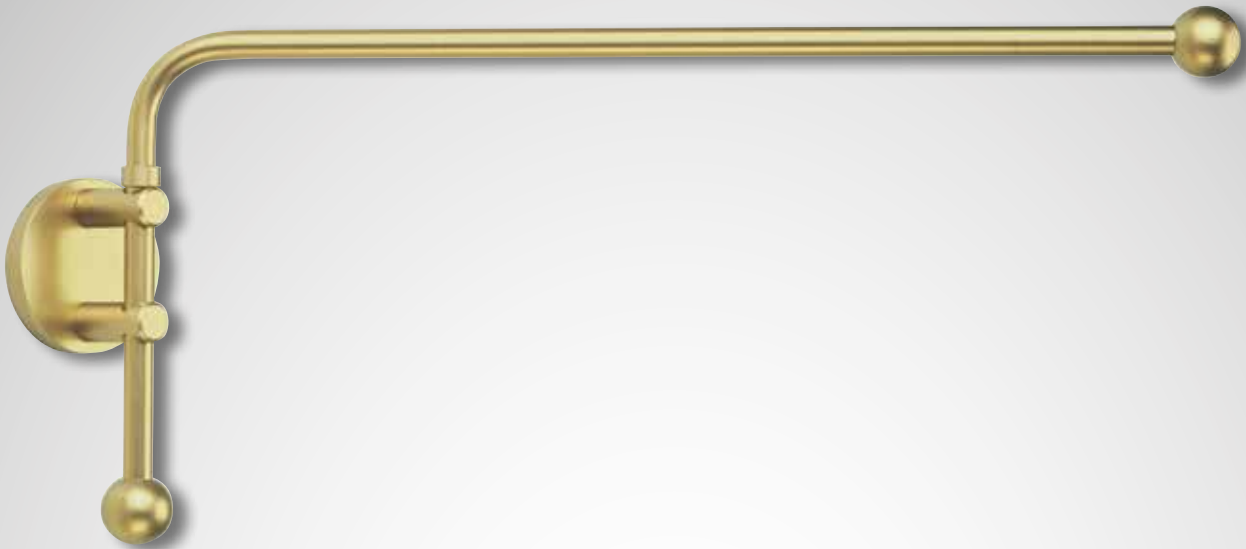

Vario 1208-75

edelstahl	50	schwarz	13
		chrom matt	25
		gold matt	75

Schwenkstange Ø 12 mm

	Länge	Preis	Preis
<p>1300 1250 190 70</p> <p>1208 Vario</p>	125 cm	184,-	103,-
	kürzbar		
	Wandabstand: 5 cm		

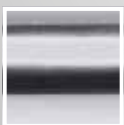

50 | edelstahl



13 | schwarz



25 | chrom matt

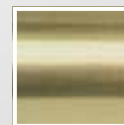





75 | gold matt



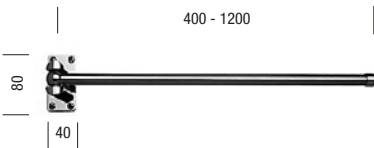

## Schwenkstange Ø 16 mm

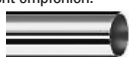
messing glanz	-23		nickel matt	-29	
---------------	-----	-------------------------------------------------------------------------------------	-------------	-----	-------------------------------------------------------------------------------------

Bestellangaben: 1996-16 - Farbe - Länge		Länge	Preis	Preis
		40 cm	152,-	152,-
		60 cm	161,-	161,-
		80 cm	170,-	170,-
		100 cm	179,-	179,-
		120 cm	188,-	188,-
		kürzbar Wandabstand: 4 cm		
<b>1996-16</b>	<b>Schwenkstange</b> Ø 16 mm			
	Einzelteile für eine individuelle Farbzusammenstellung	für Ø 16 mm VE= 2 Stück	120,-	120,-
<b>996</b>	<b>Wandträger</b>			
		für Ø 16 mm VE= 2 Stück	13,-	13,-
<b>124016</b>	<b>Endkappe</b>			
	Rohrlängen über 120 cm werden nicht empfohlen.	Ø 16 mm Lagerlänge 5 m Preis per m	38,-	38,-
<b>800-16</b>	<b>Messing-Rohr</b>			
		Ø 16 mm Fixlänge (Zuschnitt) Preis per m	45,60	45,60
<b>800-16</b>	<b>Messing-Rohr</b>			

12 mm | **ferro**





Piko 1301-50



Topo 1303-50





Patro 1305-50



Mira 1307-50







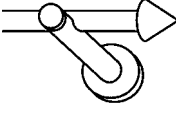
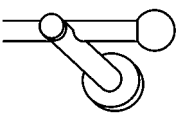
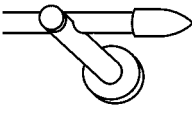

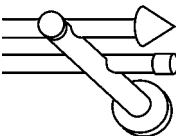
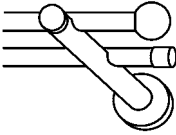
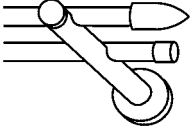
50 | edelstahl

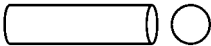
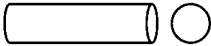
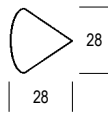
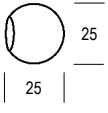
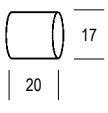
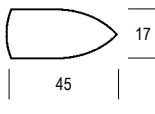
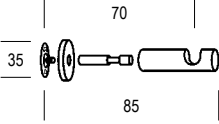
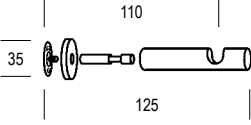
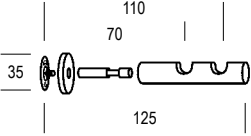
mit Haken		mit Ringen	
edelstahl	50	edelstahl	55

1-Lauf	Länge	Haken/Ringe	Preis	Preis
 1301 Piko	80	12	158,-	178,-
	100	14	162,-	185,-
	120	16	166,-	193,-
	140	20	168,-	200,-
	160	22	215,-	251,-
	180	24	219,-	258,-
 1303 Topo	200	28	220,-	265,-
	220	30	222,-	271,-
	240	34	224,-	280,-
	260	36	228,-	287,-
	280	38	229,-	292,-
 1305 Patro	300	42	231,-	301,-
	320	44	278,-	351,-
	340	48	282,-	360,-
	360	50	285,-	367,-
	380	52	288,-	373,-
	400	56	291,-	380,-
Preis je 20 cm			4,-	8,-
Abschlag Wandlager je Seite			43,30	43,30
3. Träger			ab 1,60 m	ab 1,60 m
4. Träger			ab 3,20 m	ab 3,20 m

2-Lauf	Länge	Haken/Ringe	Preis	Preis
 1302 Piko	80	24	215,-	255,-
	100	28	219,-	265,-
	120	32	223,-	275,-
	140	40	227,-	293,-
	160	44	285,-	357,-
	180	48	290,-	369,-
 1304 Topo	200	56	293,-	385,-
	220	60	299,-	398,-
	240	68	304,-	416,-
	260	72	311,-	430,-
	280	76	319,-	444,-
 1306 Patro	300	84	329,-	468,-
	320	88	370,-	522,-
	340	96	385,-	543,-
	360	100	397,-	562,-
	380	104	409,-	580,-
	400	112	419,-	603,-
Preis je 20 cm			10,-	19,-
Abschlag Wandlager je Seite			48,00	48,00
3. Träger			ab 1,60 m	ab 1,60 m
4. Träger			ab 3,20 m	ab 3,20 m

	Artikel	Oberfläche	Art.-Nr.	Preis
	<b>Edelstahlrohr</b> 12 mm Länge: 6 m Längen m	edelstahl	1300150	33,60
	<b>Edelstahlrohr</b> 12 mm Zuschnitte m	edelstahl	Z1300150	39,10
	<b>Endknopf Piko</b> Edelstahl Stück	edelstahl	1340050	16,80
	<b>Endkugel Topo</b> Edelstahl Stück	edelstahl	1343050	16,80
	<b>Endkappe Mira</b> Edelstahl Stück	edelstahl	1342050	16,80
	<b>Endknopf Patro</b> Edelstahl Stück	edelstahl	1341050	16,80
	<b>Träger Ferro</b> <b>1-Lauf, 8 cm</b> Edelstahl Stück	edelstahl	1310250	47,20
	<b>Träger Ferro</b> <b>1-Lauf, 12 cm</b> Edelstahl Stück	edelstahl	1320250	48,90
	<b>Träger Ferro</b> <b>2-Lauf</b> Edelstahl Stück	edelstahl	1330250	55,80

	Artikel	Oberfläche	Art.-Nr.	Preis
	<b>Trägerverlängerung</b> Edelstahl 4 cm Stück	edelstahl	1336450	13,50
40				
	<b>Wandlager Ferro</b> Edelstahl Stück	edelstahl	1345050	20,70
20				
	<b>Ringhaken Ferro</b> Edelstahl Stück	edelstahl	1381050	0,35
20				
	<b>Faltenhaken</b> Kunststoff Öse 3 mm für Ringhaken Ferro Stück	glasklar	1382000	0,24
21				
	<b>Ring mit Faltenhaken</b> Edelstahl kantig Stück	edelstahl	1378250	2,00
24				
	<b>Faltenhaken mit flacher Öse</b> Kunststoff Stück	edelstahlfarbig	1781025	0,24

12 mm | **goa**

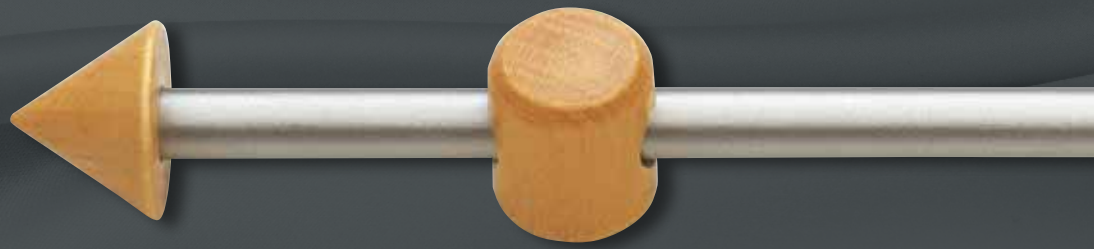

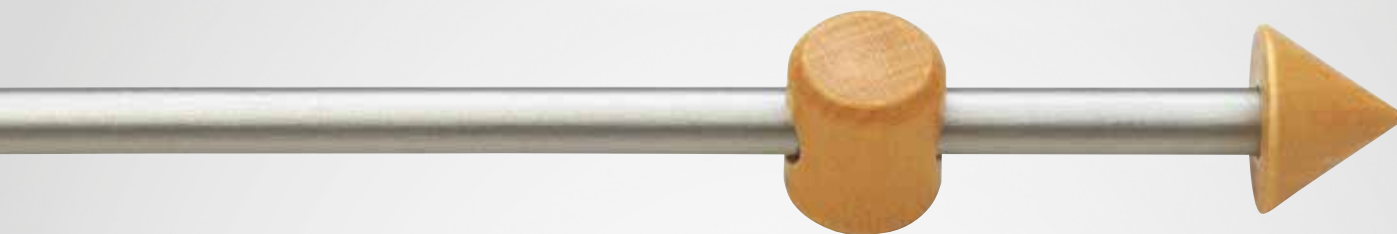

Gom 1209-54



Gea 1213-25



Gos 1207-75

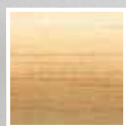

02 | natur

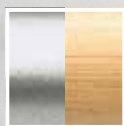

54 | chrom matt/  
natur



06 | weiß





25 | chrom matt



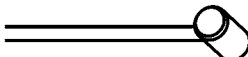

75 | gold matt

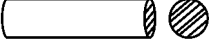
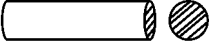
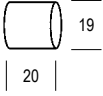
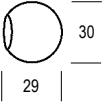
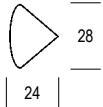
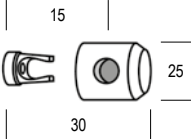
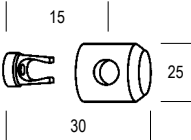
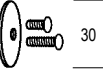
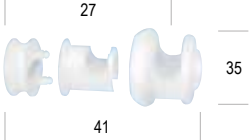
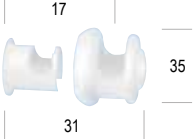

		natur chrom matt/natur	02 54	weiß chrom matt gold matt	06 25 75
1-Lauf	Länge	Preis		Preis	
 <b>1207 Gos</b>	60	18,40		18,40	
	90	21,00		21,00	
	120	23,70		23,70	
	150	36,90		36,90	
	180	39,40		39,40	
 <b>1209 Gom</b>	60	36,90		36,90	
	90	39,50		39,50	
	120	42,20		42,20	
	150	55,40		55,40	
	180	58,00		58,00	
 <b>1213 Gea</b>	60	36,90		36,90	
	90	39,50		39,50	
	120	42,20		42,20	
	150	55,40		55,40	
	180	58,00		58,00	
3. Träger		ab 1,50 m		ab 1,50 m	

Befestigungstechnik nur für Holzstangen geeignet.

	Artikel	Oberfläche	Art.-Nr.	Preis
	<b>Holzstange ca. 12 mm</b> Länge: ca. 3,60 m  Längen m	natur	1200002	8,30
		weiß	1200006	8,30
		chrom matt	1200025	8,30
		gold matt	1200075	8,30
	<b>Holzstange ca. 12 mm</b>  Zuschnitte m	natur	Z1200002	9,80
		weiß	Z1200006	9,80
		chrom matt	Z1200025	9,80
		gold matt	Z1200075	9,80
	<b>Endkappe Mila</b> Holz  Stück	natur	AV 1222302	2,97
		weiß	AV 1222306	2,97
		chrom matt	AV 1222325	2,97
	<b>Endkugel Kio</b> Holz  Stück	natur	1222002	5,20
		weiß	1222006	5,20
		chrom matt	1222025	5,20
		gold matt	1222075	5,20
	<b>Endknopf Glis</b> Holz  Stück	natur	1225002	5,20
		weiß	1225006	5,20
		chrom matt	1225025	5,20
		gold matt	1225075	5,20
	<b>Endträger Goa</b> Holz  Stück	natur	1210002	6,49
		weiß	1210006	6,49
		chrom matt	1210025	6,49
		gold matt	1210075	6,49
	<b>Zwischenträger Göta</b> Holz  Stück	natur	1215002	10,56
		weiß	1215006	10,56
		chrom matt	1215025	10,56
		gold matt	1215075	10,56
	<b>Selbstklebeplatte</b> Kunststoff für Träger Goa + Göta  Stück	weiß	1218706	3,70
	<b>Zwischenträger Steckverschluss</b> Kunststoff  Stück	weiß	1250206	4,79
	<b>Zwischenträger Steckverschluss kurz</b>  Stück	weiß	1241500	3,91
	<b>Trägerverlängerung 10 mm</b> Stück	weiß	1245000	1,21

16 mm | **corto**





Corto 1665-97



Ronda 1669-97





Cado 1667-97



97 | edelstahl-optik

Garnituren mit Innenlauf

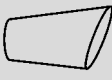

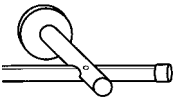
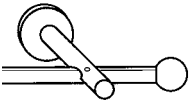
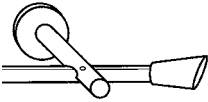
<b>Corto</b>		<b>Ronda</b>		<b>Cado</b>	
edelstahloptik		edelstahloptik			
		97		97	

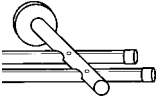
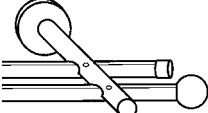
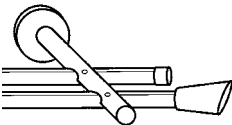
1-Lauf	Länge	Gleiter	Preis	Preis
 1665 Corto	100	16	96,-	114,-
	120	18	101,-	119,-
	140	22	103,-	121,-
	160	26	108,-	126,-
	180	28	133,-	151,-
 1669 Ronda	200	32	137,-	155,-
	220	34	140,-	159,-
	240	38	144,-	163,-
	260	42	149,-	167,-
	280	44	153,-	171,-
 1667 Cado	300	48	157,-	177,-
	320	50	183,-	201,-
	340	54	188,-	206,-
	360	58	191,-	209,-
	380	60	195,-	213,-
	400	64	200,-	218,-
	Preis je 20 cm			4,00
Abschlag Wandlager je Seite			15,40	20,00
3. Träger			ab 1,80 m	ab 1,80 m
4. Träger			ab 3,20 m	ab 3,20 m

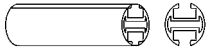
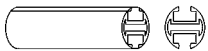
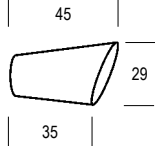
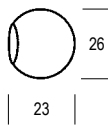
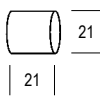
2-Lauf	Länge	Gleiter	Preis	Preis
 1666 Corto	100	32	137,-	155,-
	120	36	144,-	162,-
	140	44	151,-	169,-
	160	52	159,-	177,-
	180	56	191,-	211,-
 1670 Ronda	200	64	200,-	218,-
	220	68	206,-	225,-
	240	76	215,-	234,-
	260	84	222,-	241,-
	280	88	229,-	247,-
 1668 Cado	300	96	240,-	258,-
	320	100	271,-	290,-
	340	108	280,-	298,-
	360	116	286,-	306,-
	380	120	294,-	312,-
	400	128	301,-	321,-
	Preis je 20 cm			7,50
Abschlag Wandlager je Seite			16,50	21,10
3. Träger			ab 1,80 m	ab 1,80 m
4. Träger			ab 3,20 m	ab 3,20 m

	Artikel	Oberfläche	Art.-Nr.	Preis
	<b>Innenlaufstange 16 mm</b>	edelstahloptik	1500297	24,10
	Aluminium			
	6 mm-Lauf			
	Länge: 6 m			
	Längen m			
	<b>Innenlaufstange 16 mm</b>	edelstahloptik	Z1500297	29,00
	Aluminium			
	6 mm-Lauf			
	Zuschnitte m			
	<b>Endknopf Cado</b>	edelstahloptik	1632197	13,10
	Metall			
	Stück			
	<b>Endkugel Ronda</b>	edelstahloptik	1643097	13,10
	Metall			
	Stück			
	<b>Endkappe Corto</b>	edelstahloptik	1735097	8,50
	Metall			
	Stück			

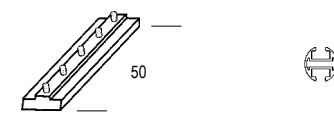
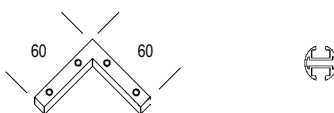
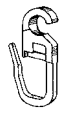
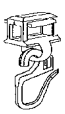
	Artikel	Oberfläche	Art.-Nr.	Preis
	<b>Träger Corto</b> <b>1-Lauf, 8 cm</b> Metall Stück	edelstahloptik	1630497	22,20
	<b>Träger Corto</b> <b>1-Lauf, 12 cm</b> Metall Stück	edelstahloptik	1630597	26,80
	<b>Träger Corto</b> <b>2-Lauf</b> Metall Stück	edelstahloptik	1630697	30,10
	<b>Trägerverlängerung 4 cm</b> Metall Stück	edelstahloptik	1636297	10,60
	<b>Wandlager Corto</b> Metall Stück	edelstahloptik	1645097	15,30
	<b>Deckenträger</b> Metall 2,5 cm Stück	edelstahloptik	2150497	26,70
	<b>Deckenträger</b> Metall Stück	edelstahloptik	2140097	41,80
	<b>Deckenträger</b> Metall 50 cm kürzbar Stück	edelstahloptik	164995-116	48,00

	Artikel	Oberfläche	Art.-Nr.	Preis
	<b>Profilverbinder</b> Aluminium	alu blank	1520070	9,30
	Stück			
	<b>Profil-Eckverbinder 90°</b> Aluminium	alu blank	1521070	16,80
	Stück			
	<b>Faltenhaken</b> Kunststoff Öse 6 mm	glasklar	1381000	0,15
	Stück			
	<b>Clic-Gleiter mit Faltenhaken</b> Kunststoff für 6 mm-Lauf	weiß	2000316	0,25
	Stück			
	<b>End- und Zwischenfeststeller</b> Kunststoff für 6 mm-Lauf	glasklar	2000516	0,30
	Stück			



16 mm | **rustika**





Ranka 1671-13



Rustika 1689-03



13 | schwarz





25 | chrom matt



03 | graphit



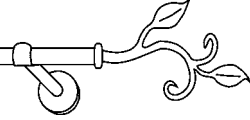
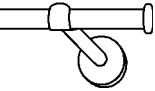

04 | bronze

Ranka			Rustika		
	graphit bronze chrom matt	03 04 25		graphit bronze chrom matt	03 04 25
schwarz	13		schwarz	13	

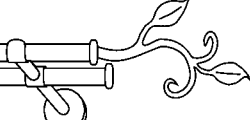
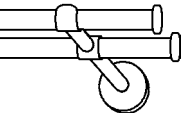
1-Lauf	Länge	Ringe	Preis	Preis	Preis	Preis	
	100	14	138,-	177,-	105,-	139,-	
	120	16	140,-	184,-	108,-	145,-	
	140	20	144,-	192,-	110,-	155,-	
	160	22	147,-	200,-	113,-	161,-	
	180	24	176,-	236,-	142,-	199,-	
	200	28	179,-	246,-	145,-	207,-	
	220	30	182,-	252,-	148,-	214,-	
	240	34	184,-	260,-	151,-	223,-	
	260	36	187,-	268,-	154,-	229,-	
	280	38	190,-	274,-	156,-	236,-	
		300	42	191,-	282,-	159,-	243,-
		320	44	194,-	288,-	161,-	251,-
		340	48	197,-	298,-	165,-	259,-
		360	50	226,-	334,-	194,-	297,-
380		52	229,-	340,-	196,-	303,-	
400		56	232,-	350,-	199,-	312,-	
Preis je 20 cm			2,40	6,10	2,40	6,10	
Abschlag Wandlager je Seite			34,30	39,40	17,50	20,40	
3. Träger			ab 1,80 m	ab 1,80 m	ab 1,80 m	ab 1,80 m	
4. Träger			ab 3,60 m	ab 3,60 m	ab 3,60 m	ab 3,60 m	

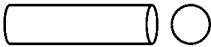
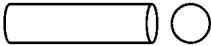
2-Lauf	Länge	Ringe	Preis	Preis	Preis	Preis	
	100	28	207,-	272,-	174,-	235,-	
	120	32	212,-	286,-	179,-	248,-	
	140	40	219,-	304,-	185,-	266,-	
	160	44	224,-	317,-	190,-	278,-	
	180	48	270,-	375,-	237,-	336,-	
	200	56	276,-	393,-	243,-	356,-	
	220	60	281,-	405,-	248,-	368,-	
	240	68	288,-	425,-	254,-	386,-	
	260	72	293,-	437,-	259,-	399,-	
	280	76	298,-	450,-	264,-	411,-	
		300	84	303,-	467,-	270,-	430,-
		320	88	307,-	480,-	275,-	442,-
		340	96	315,-	499,-	281,-	460,-
		360	100	316,-	557,-	328,-	518,-
380		104	366,-	569,-	333,-	531,-	
400		112	373,-	587,-	339,-	549,-	
Preis je 20 cm			4,90	13,30	4,90	13,30	
Abschlag Wandlager je Seite			40,20	44,60	23,40	25,60	
3. Träger			ab 1,80 m	ab 1,80 m	ab 1,80 m	ab 1,80 m	
4. Träger			ab 3,60 m	ab 3,60 m	ab 3,60 m	ab 3,60 m	

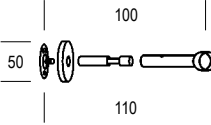
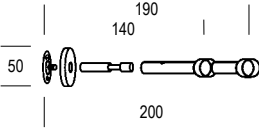
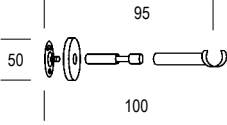
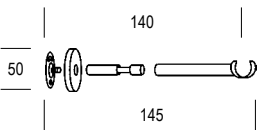
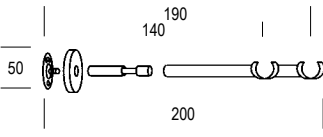
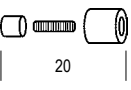
	Artikel	Oberfläche	Art.-Nr.	Preis
	<b>Stahlrohr 16 mm</b> Länge: 5,00 m  Längen m	schwarz	1600013	10,10
		chrom matt	1600025	18,30
		graphit	1610003	18,30
		bronze	1610004	18,30
	<b>Stahlrohr 16 mm</b>  Zuschnitte m	schwarz	Z1600013	15,70
		chrom matt	Z1600025	23,70
		graphit	Z1610003	23,70
		bronze	Z1610004	23,70
	<b>Endknopf Ranka</b> Metall  Stück	schwarz	1760113	26,70
		chrom matt	1760125	30,44
		graphit	1760103	30,44
		bronze	1760104	30,44
	<b>Endkappe Rustika</b> Metall  Stück	schwarz	1760713	9,90
		chrom matt	1760725	11,40
		graphit	1760703	11,40
		bronze	1760704	11,40
	<b>Träger City</b> <b>1-Lauf, 10 cm</b> Metall  Stück	schwarz	1652013	26,70
		chrom matt	1652025	30,40
		graphit	1652003	30,40
		bronze	1652004	30,40
	<b>Träger City</b> <b>2-Lauf</b> Metall  Stück	schwarz	1651013	41,80
		chrom matt	1651025	45,60
		graphit	1651003	45,60
		bronze	1651004	45,60
	<b>Einlegeträger</b> <b>1-Lauf, 10 cm</b> Metall  Stück	schwarz	1760413	26,70
		chrom matt	1760425	30,40
		graphit	1760403	30,40
		bronze	1760404	30,40
	<b>Einlegeträger</b> <b>1-Lauf, 14 cm</b> Metall  Stück	schwarz	1760513	28,10
		chrom matt	1760525	33,50
		graphit	1760503	33,50
		bronze	1760504	33,50
	<b>Einlegeträger</b> <b>2-Lauf</b> Metall  Stück	schwarz	1760613	41,80
		chrom matt	1760625	45,60
		graphit	1760603	45,60
		bronze	1760604	45,60
	<b>Verlängerung 2 cm</b> <b>für Träger</b> Metall  Stück	schwarz	1652313	5,30
		chrom matt	1652325	7,60
		graphit	1652303	7,60
		bronze	1652304	7,60

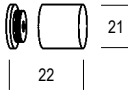
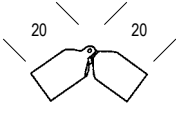
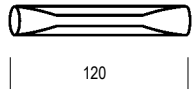
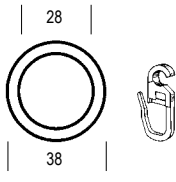
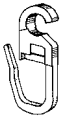
	Artikel	Oberfläche	Art.-Nr.	Preis
	<b>Wandlager</b>	schwarz	1645013	19,10
	Metall	chrom matt	1645025	21,40
		graphit	1645003	21,40
		bronze	1645004	21,40
	Stück			
	<b>Erkergelenk</b>	schwarz	1755013	42,50
	Metall	chrom matt	1755025	44,00
	für 16 mm-Rohr	graphit	1755003	44,00
		bronze	1755004	44,00
	Stück			
	<b>Rohrverbinder</b>	verzinkt	1600107	5,40
	Metall			
	Stück			
	<b>Ring mit farbigem Faltenhaken</b>	schwarz	1878213	0,27
	Kunststoff	grau	1878225	1,40
		graphit	1878203	1,50
		bronze	1878204	1,50
	Stück			
	<b>Faltenhaken</b>	schwarz	1281013	0,15
	Kunststoff	silberfarbig	1281025	0,15
	Öse 6 mm	braun	1281004	0,15
	Stück			

20 mm | **function**

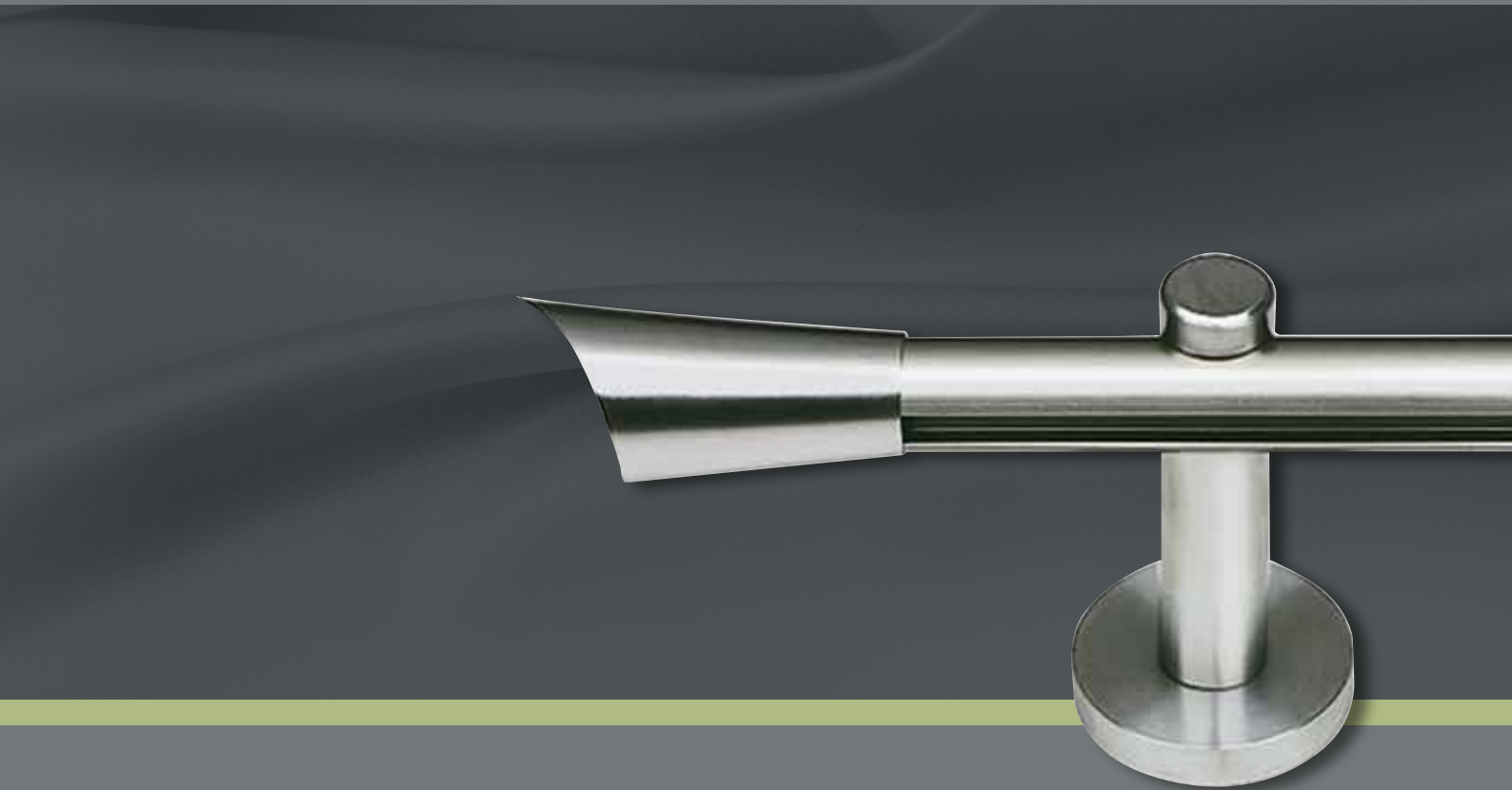



Flika 3519-50



Fenja 3503-50



50 | edelstahl

<b>Flika</b>		<b>Fenja</b>	
edelstahl	50	edelstahl	50

## Garnituren mit Innenlauf

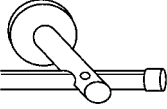
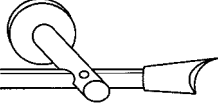
1-Lauf	Länge	Gleiter	Preis	Preis	
 3519 Flika	100	16	172,-	240,-	
	120	18	174,-	242,-	
	140	22	177,-	245,-	
	160	26	179,-	247,-	
	180	28	182,-	249,-	
 3503 Fenja	200	32	184,-	252,-	
	220	34	242,-	311,-	
	240	38	246,-	313,-	
	260	42	248,-	316,-	
	280	44	251,-	318,-	
	300	48	254,-	322,-	
	320	50	257,-	324,-	
	340	54	259,-	327,-	
	360	58	317,-	386,-	
	380	60	320,-	388,-	
	400	64	322,-	391,-	
	Preis je 20 cm			2,40	2,40
	Abschlag Wandlager je Seite			40,90	75,10
	3. Träger			ab 2,20 m	ab 2,20 m
	4. Träger			ab 3,60 m	ab 3,60 m

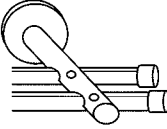
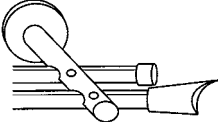
2-Lauf	Länge	Gleiter	Preis	Preis	
 3520 Flika	100	32	298,-	329,-	
	120	36	303,-	334,-	
	140	44	307,-	338,-	
	160	52	312,-	343,-	
	180	56	317,-	347,-	
 3504 Fenja	200	64	322,-	352,-	
	220	68	405,-	436,-	
	240	76	410,-	441,-	
	260	84	415,-	444,-	
	280	88	420,-	449,-	
	300	92	424,-	455,-	
	320	100	429,-	460,-	
	340	108	434,-	465,-	
	360	116	517,-	548,-	
	380	120	522,-	553,-	
	400	128	527,-	558,-	
	Preis je 20 cm			4,80	4,80
	Abschlag Wandlager je Seite			48,50	82,70
	3. Träger			ab 2,20 m	ab 2,20 m
	4. Träger			ab 3,60 m	ab 3,60 m





Flika 3521-50



Fenja 3509-50



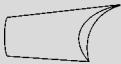

50 | edelstahl

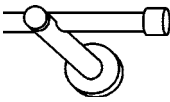
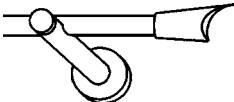

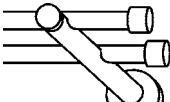
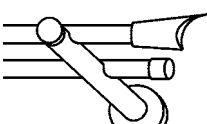

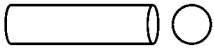
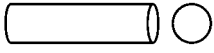
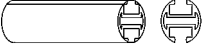
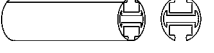
<b>Flika</b>		<b>Fenja</b>	
edelstahl	50	edelstahl	50

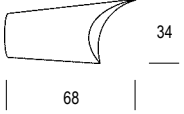
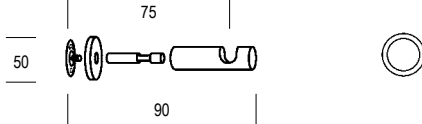
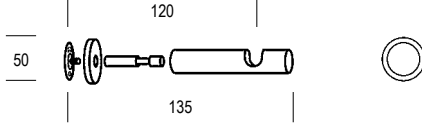
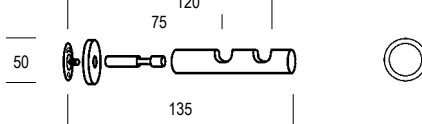
1-Lauf	Länge	Gleiter	Preis	Preis	
 <b>3521 Flika</b>	100	14	211,-	253,-	
	120	16	224,-	258,-	
	140	20	243,-	270,-	
	160	22	255,-	283,-	
	180	24	269,-	297,-	
 <b>3509 Fenja</b>	200	28	287,-	315,-	
	220	30	349,-	376,-	
	240	34	367,-	393,-	
	260	46	379,-	407,-	
	280	48	392,-	419,-	
	300	42	410,-	438,-	
	320	44	424,-	450,-	
	340	48	444,-	468,-	
	360	50	455,-	482,-	
	380	52	466,-	495,-	
	400	56	488,-	513,-	
	Preis je 20 cm			15,70	16,90
	Abschlag Wandlager je Seite			38,70	72,90
	3. Träger			ab 2,20 m	ab 2,20 m
	4. Träger			ab 4,00 m	ab 4,00 m

2-Lauf	Länge	Ringe	Preis	Preis	
 <b>3522 Flika</b>	100	28	336,-	363,-	
	120	32	362,-	389,-	
	140	40	399,-	428,-	
	160	44	424,-	450,-	
	180	48	449,-	477,-	
 <b>3510 Fenja</b>	200	56	489,-	513,-	
	220	60	568,-	594,-	
	240	68	606,-	634,-	
	260	72	629,-	657,-	
	280	76	656,-	684,-	
	300	84	695,-	721,-	
	320	88	718,-	745,-	
	340	96	756,-	784,-	
	360	100	782,-	810,-	
	380	104	806,-	834,-	
	400	112	846,-	871,-	
	Preis je 20 cm			31,50	31,50
	Abschlag Wandlager je Seite			37,80	72,00
	3. Träger			ab 2,20 m	ab 2,20 m
	4. Träger			ab 4,00 m	ab 4,00 m

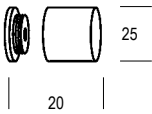
	Artikel	Oberfläche	Art.-Nr.	Preis
	<b>Edelstahlrohr 20 mm</b> Länge: 6 m	edelstahl	2010050	23,80
	Längen m			
	<b>Edelstahlrohr 20 mm</b> Zuschnitte m	edelstahl	Z2010050	28,50
	Zuschnitte m			
	<b>Aluminium-Innenlaufstange 20 mm</b> 6 mm-Lauf Länge: 6 m	edelstahl	2000250	23,90
	Längen m			
	<b>Aluminium-Innenlaufstange 20 mm</b> 6 mm-Lauf Zuschnitte m	edelstahl	Z2000250	28,80
	Zuschnitte m			
	<b>Endkappe Alba</b> Edelstahl	edelstahl	2135050	13,70
	Stück			
	<b>Endknopf Fenja</b> Edelstahl	edelstahl	2110150	47,90
	Stück			
	<b>Träger Bari</b> 1-Lauf, 8 cm Edelstahl	edelstahl	2130150	53,90
	Stück			
	<b>Träger Bari</b> 1-Lauf, 12 cm Edelstahl	edelstahl	2130350	66,80
	Stück			
	<b>Träger Bari</b> 2-Lauf Edelstahl	edelstahl	2130250	68,20
	Stück			

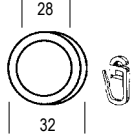
	Artikel	Oberfläche	Art.-Nr.	Preis
	<b>Träger Function</b> <b>1-Lauf, 8 cm</b> Edelstahl Stück	edelstahl	2130450	56,10
	<b>Träger Function</b> <b>1-Lauf, 12 cm</b> Edelstahl Stück	edelstahl	2130550	74,30
	<b>Träger Function</b> <b>2-Lauf</b> Edelstahl Stück	edelstahl	2130650	78,90
	<b>Trägerverlängerung 5,5 cm</b> Edelstahl Stück	edelstahl	2136250	40,20
	<b>Deckenträger</b> Edelstahl 2,5 cm Stück	edelstahl	2150450	26,70
	<b>Deckenträger</b> Edelstahl Stück	edelstahl	2140050	56,10
	<b>Deckenträger</b> Edelstahl 50 cm kürzbar Stück	edelstahl	164995-116	48,00

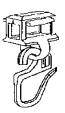
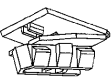
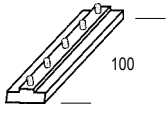
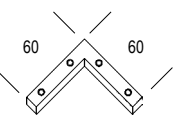
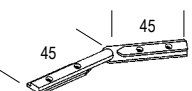
	Artikel	Oberfläche	Art.-Nr.	Preis
	<b>Wandlager</b> Edelstahl	edelstahl	2145050	28,90
	Stück			
	<b>Erkerbogen</b> Edelstahl	edelstahl	2155050	63,00
	Stück			
	<b>Ring mit Faltenhaken</b> Edelstahl kantig	edelstahl	1778250	3,90
	Stück			
	<b>Faltenhaken mit flacher Öse</b> Kunststoff	glasklar	1781000	0,15
	Stück			
	<b>Clic-Gleiter mit Faltenhaken</b> Kunststoff für 6 mm-Lauf Stück	weiß	2000316	0,25
	<b>End- und Zwischenfeststeller</b> Kunststoff für 6 mm-Lauf Stück	glasklar	2000516	0,30
	<b>Profilverbinder</b> Aluminium	alu blank	1520070	9,30
	Stück			
	<b>Profil-Eckverbinder 90°</b> Aluminium	alu blank	1521070	16,80
	Stück			
	<b>Eckverbinder 90°-180°</b> Aluminium Stück	alu blank	1520371	24,00

20 mm | **adriano**

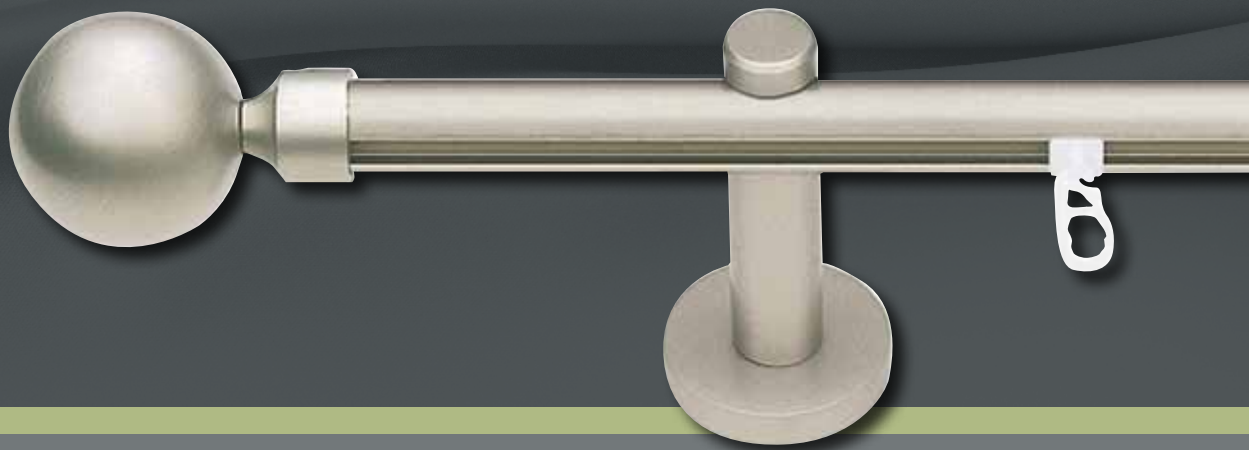



Flika 3519-62



Fenja 3503-63



Napoli 2053-63

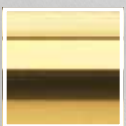

60 | messing glanz

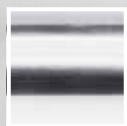

61 | chrom glanz

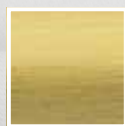



62 | messing matt



63 | nickel matt





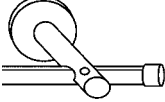
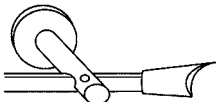
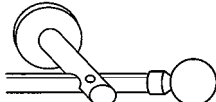

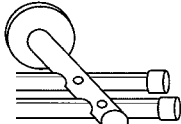
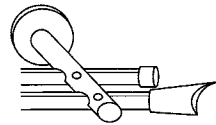
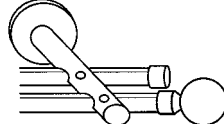
Garnituren mit Innenlauf

Flika	Folja	Napoli
		
ms glanz 60 ms matt 62 nickel matt 63	ms glanz 60 ms matt 62 nickel matt 63	ms glanz 60 ms matt 62 nickel matt 63
chrom glanz 61	chrom glanz 61	chrom glanz 61

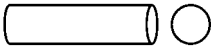
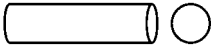

1-Lauf	Länge	Gleiter	Preis	Preis	Preis	Preis	Preis	Preis	
 3519 Flika	100	16	208,-	222,-	276,-	298,-	336,-	347,-	
	120	18	222,-	235,-	289,-	310,-	349,-	361,-	
	140	22	234,-	248,-	303,-	323,-	362,-	374,-	
	160	26	247,-	260,-	315,-	336,-	375,-	386,-	
	180	28	260,-	274,-	328,-	350,-	389,-	399,-	
 3503 Fenja	200	32	274,-	287,-	341,-	362,-	402,-	413,-	
	220	34	336,-	355,-	404,-	431,-	465,-	480,-	
	240	38	349,-	368,-	418,-	444,-	477,-	494,-	
	260	42	362,-	381,-	430,-	456,-	490,-	507,-	
	280	44	375,-	393,-	443,-	470,-	503,-	520,-	
 2053 Napoli	300	48	390,-	408,-	457,-	484,-	518,-	535,-	
	320	50	403,-	421,-	471,-	497,-	531,-	547,-	
	340	54	415,-	434,-	484,-	511,-	543,-	560,-	
	360	58	478,-	502,-	547,-	578,-	608,-	629,-	
	380	60	491,-	516,-	559,-	592,-	620,-	641,-	
	400	64	505,-	529,-	572,-	605,-	633,-	655,-	
	Preis je 20 cm			13,30	13,30	13,30	13,30	13,30	13,30
	Abschlag Wandlager je Seite			21,00	21,00	58,90	58,90	83,90	83,90
	3. Träger			ab 2,20 m	ab 2,20 m	ab 2,20 m	ab 2,20 m	ab 2,20 m	ab 2,20 m
	4. Träger			ab 3,60 m	ab 3,60 m	ab 3,60 m	ab 3,60 m	ab 3,60 m	ab 3,60 m

2-Lauf	Länge	Gleiter	Preis	Preis	Preis	Preis	Preis	Preis
 3520 Flika	100	32	345,-	367,-	414,-	442,-	473,-	493,-
	120	36	370,-	392,-	439,-	468,-	499,-	518,-
	140	44	397,-	417,-	465,-	494,-	525,-	543,-
	160	52	422,-	443,-	490,-	519,-	551,-	570,-
	180	56	448,-	470,-	516,-	545,-	576,-	595,-
 3504 Fenja	200	64	473,-	495,-	542,-	571,-	601,-	621,-
	220	68	572,-	601,-	640,-	676,-	701,-	727,-
	240	76	598,-	627,-	667,-	703,-	726,-	753,-
	260	84	623,-	652,-	692,-	729,-	752,-	778,-
	280	88	650,-	678,-	718,-	754,-	778,-	805,-
 2054 Napoli	300	92	676,-	706,-	744,-	782,-	805,-	831,-
	320	100	702,-	731,-	771,-	807,-	830,-	857,-
	340	108	729,-	756,-	796,-	833,-	857,-	883,-
	360	116	827,-	863,-	894,-	939,-	955,-	989,-
	380	120	852,-	888,-	921,-	964,-	980,-	1015,-
	400	128	879,-	915,-	946,-	990,-	1007,-	1041,-
	Preis je 20 cm			25,40	25,40	25,40	25,40	25,40
Abschlag Wandlager je Seite			11,00	11,00	49,20	49,20	74,20	74,20
3. Träger			ab 2,20 m	ab 2,20 m	ab 2,20 m	ab 2,20 m	ab 2,20 m	ab 2,20 m
4. Träger			ab 3,60 m	ab 3,60 m	ab 3,60 m	ab 3,60 m	ab 3,60 m	ab 3,60 m

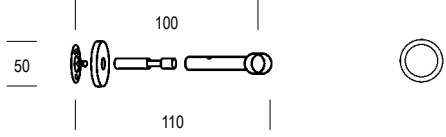
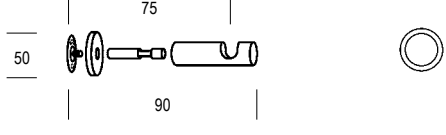

	Artikel	Oberfläche	Art.-Nr.	Preis
	<b>Stahlrohr mit Messingüberzug</b> <b>20 mm</b> Länge: 5 m Längen m	messing glanz	2010060	39,40
		chrom glanz	2010061	55,70
		messing matt	2010062	39,40
		nickel matt	2010063	60,00
	<b>Stahlrohr mit Messingüberzug</b> <b>20 mm</b> Zuschnitte m	messing glanz	Z2010060	44,70
		chrom glanz	Z2010061	61,00
		messing matt	Z2010062	44,70
		nickel matt	Z2010063	66,00
	<b>Innenlaufstange 20 mm</b> Aluminium 6 mm-Lauf Länge: 6 m Längen m	messing glanz	2000260	79,70
		chrom glanz	2000261	79,70
		messing matt	808-20-109	44,80
		nickel matt	2000263	23,90
	<b>Innenlaufstange 20 mm</b> Aluminium 6 mm-Lauf Zuschnitte m	messing glanz	Z2000260	85,20
		chrom glanz	Z2000261	85,20
		messing matt	Z808-20-109	49,30
		nickel matt	Z2000263	28,80
	<b>Endkugel Napoli</b> Messing massiv Stück	messing glanz	2180060	75,90
		chrom glanz	2180061	75,90
		messing matt	2180062	75,90
		nickel matt	2180063	75,90
	<b>Endknopf Fenja</b> Messing massiv Stück	messing glanz	2110160	45,60
		chrom glanz	2110161	50,90
		messing matt	2110162	45,60
		nickel matt	2110163	50,90
	<b>Endkappe Alba</b> Messing massiv Stück	messing glanz	2135060	11,40
		chrom glanz	2135061	13,00
		messing matt	2135062	11,40
		nickel matt	2135063	13,00
	<b>Träger Adriano</b> <b>1-Lauf, 10 cm</b> Messing massiv Stück	messing glanz	2153060	28,00
		chrom glanz	2153061	28,50
		messing matt	2153062	25,80
		nickel matt	2153063	30,20
	<b>Träger Bari</b> <b>1-Lauf, 8 cm</b> Messing massiv Stück	messing glanz	2130160	36,20
		chrom glanz	2130161	38,00
		messing matt	2130162	36,20
		nickel matt	2130163	38,00

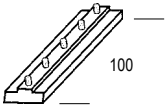
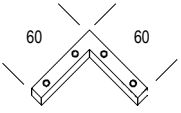
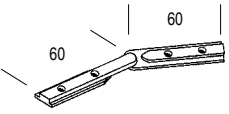
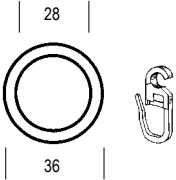
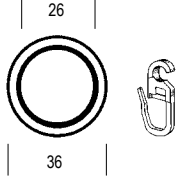
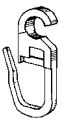
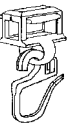
	Artikel	Oberfläche	Art.-Nr.	Preis
	<b>Träger Function</b> <b>1-Lauf, 8 cm</b> Messing massiv Stück	messing glanz	2130460	50,10
		chrom glanz	2130461	55,50
		messing matt	2130462	50,10
		nickel matt	2130463	55,50
	<b>Träger Function</b> <b>1-Lauf, 12 cm</b> Messing massiv Stück	messing glanz	2130560	64,50
		chrom glanz	2130561	72,10
		messing matt	2130562	64,50
		nickel matt	2130563	72,10
	<b>Träger Function</b> <b>2-Lauf</b> Messing massiv Stück	messing glanz	2130660	72,90
		chrom glanz	2130661	80,30
		messing matt	2130662	72,90
		nickel matt	2130663	80,30
	<b>Deckenträger</b> Messing massiv 2,5 cm Stück	messing glanz	2150460	26,70
		chrom glanz	2150461	26,70
		messing matt	2150462	26,70
		nickel matt	2150463	26,70
	<b>Deckenträger</b> Messing massiv Stück	messing glanz	2140060	56,10
		chrom glanz	2140061	56,10
		messing matt	2140062	56,10
		nickel matt	2140063	56,10
	<b>Deckenträger</b> Edelstahl 50 cm kürzbar Stück	edelstahl	164995-116	48,00
	<b>Wandlager</b> Messing massiv Stück	messing glanz	2145060	47,50
		chrom glanz	AV 2145061	20,90
		messing matt	AV 2145062	19,90
		nickel matt	2145063	47,50
	<b>Erkerbogen</b> Messing massiv Stück	messing glanz	2155060	51,60
		chrom glanz	2155061	56,90
		messing matt	2155062	51,60
		nickel matt	2155063	56,90
	<b>Rohrverbinder</b> Metall Stück	verzinkt	2000107	5,40

	Artikel	Oberfläche	Art.-Nr.	Preis
	<b>Profilverbinder</b> Aluminium	alu blank	1520070	9,30
		Stück		
	<b>Profil-Eckverbinder 90°</b> Aluminium	alu blank	1521070	16,80
		Stück		
	<b>Eckverbinder 90°-180°</b> Aluminium	alu blank	1520371	24,00
		Stück		
	<b>Ring mit Faltenhaken</b> Messing massiv rund	messing glanz	2178260	2,70
		chrom glanz	2178261	2,70
		messing matt	2178262	2,70
		nickel matt	2178263	2,70
		Stück		
	<b>Ring mit Faltenhaken mit Kunststoffgleiteinlage</b> Messing massiv rund	messing glanz	2188260	3,10
		chrom glanz	2188261	3,60
		messing matt	2188262	3,10
		nickel matt	2188263	3,60
		Stück		
	<b>Faltenhaken</b> Kunststoff Öse 4 mm	glasklar	1381001	0,15
		Stück		
	<b>Clic-Gleiter mit Faltenhaken</b> Kunststoff für 6 mm-Lauf	weiß	2000316	0,25
		Stück		
	<b>End- und Zwischenfeststeller</b> Kunststoff für 6 mm-Lauf	glasklar	2000516	0,30
		Stück		

20 mm | jet

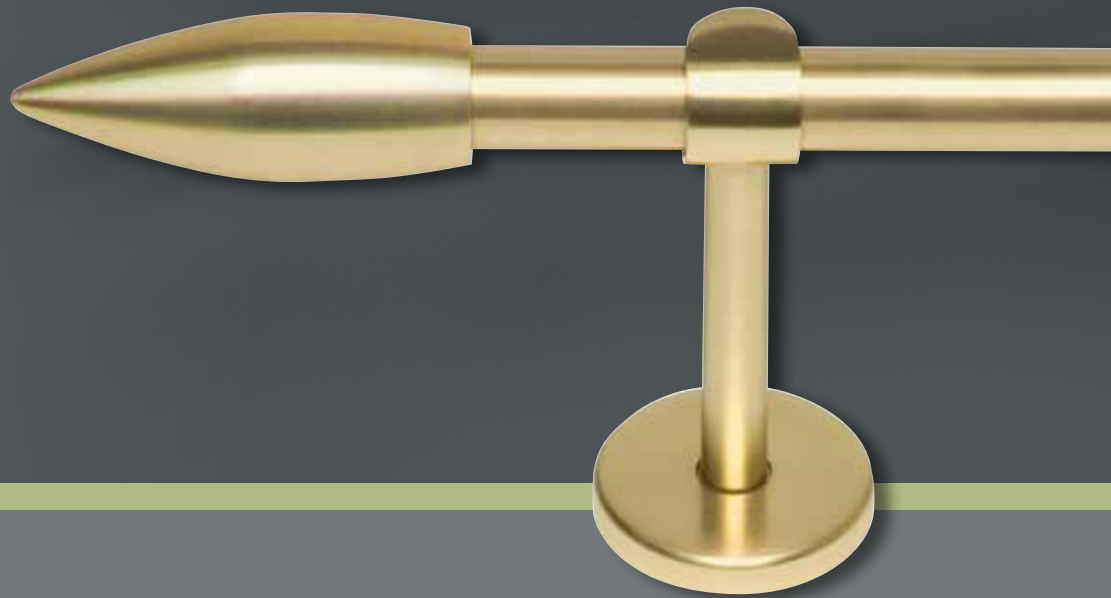



Jet 2703-97



Air 2701-98



Bora 2705-98

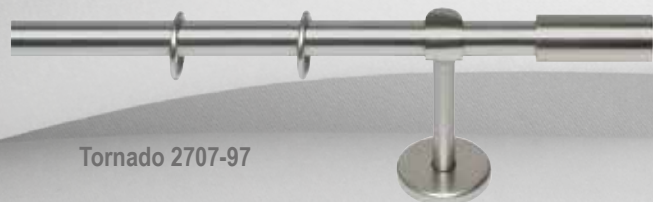



Tornado 2707-97



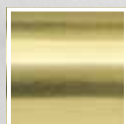



97 | satin silber

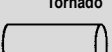

98 | messing matt optik

 Air edelstahloptik messing matt optik	 Jet edelstahloptik messing matt optik	  Bora edelstahloptik messing matt optik	97 98	97 98	97 98
-----------------------------------------------------------------------------------------------------------------------------------	------------------------------------------------------------------------------------------------------------------------------------	-------------------------------------------------------------------------------------------------------------------------------------------------------------------------------------------------------------------------	----------	----------	----------

1-Lauf	Länge	Ringe	Preis	Preis	Preis
 2701 Air	100	14	168,-	209,-	191,-
	120	16	178,-	219,-	201,-
	140	20	191,-	231,-	213,-
	160	22	200,-	241,-	223,-
	180	24	210,-	249,-	231,-
 2703 Jet	200	28	254,-	295,-	277,-
	220	30	264,-	304,-	286,-
	240	34	276,-	317,-	299,-
	260	36	278,-	327,-	309,-
	280	38	294,-	335,-	317,-
 2705 Bora	300	42	307,-	349,-	330,-
	320	44	316,-	357,-	339,-
	340	48	329,-	370,-	352,-
	360	50	339,-	379,-	361,-
	380	52	347,-	389,-	370,-
 2707 Tornado	400	56	393,-	433,-	415,-
	Preis je 20 cm		8,50	8,50	8,50
	Abschlag Wandlager je Seite		25,20	45,70	36,60
	3. Träger		ab 2,00 m	ab 2,00 m	ab 2,00 m
	4. Träger		ab 4,00 m	ab 4,00 m	ab 4,00 m

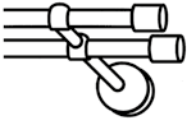
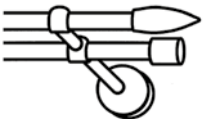
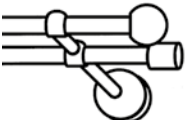
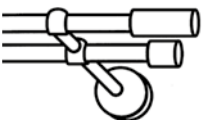
2-Lauf	Länge	Ringe	Preis	Preis	Preis
 2702 Air	100	28	272,-	313,-	295,-
	120	32	290,-	332,-	313,-
	140	40	316,-	357,-	339,-
	160	44	334,-	375,-	357,-
	180	48	352,-	392,-	374,-
 2704 Jet	200	56	418,-	459,-	441,-
	220	60	436,-	477,-	459,-
	240	68	461,-	502,-	484,-
	260	72	479,-	520,-	502,-
	280	76	497,-	539,-	520,-
 2706 Bora	300	84	523,-	564,-	546,-
	320	88	541,-	581,-	563,-
	340	96	566,-	606,-	588,-
	360	100	583,-	624,-	606,-
	380	104	601,-	643,-	624,-
 2708 Tornado	400	112	668,-	709,-	691,-
	Preis je 20 cm		18,10	18,10	18,10
	Abschlag Wandlager je Seite		26,10	46,60	37,50
	3. Träger		ab 2,00 m	ab 2,00 m	ab 2,00 m
	4. Träger		ab 4,00 m	ab 4,00 m	ab 4,00 m



Air 2713-97



Jet 2711-98



Tornado 2717-98



Bora 2715-97





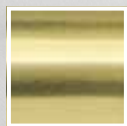

97 | edelstahloptik



98 | messing matt optik

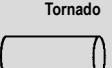

## Garnituren mit Innenlauf

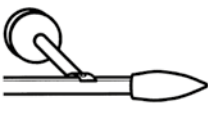
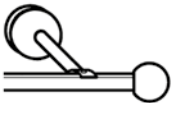
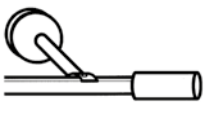
<b>Air</b>  edelstahloptik messing matt optik	<b>Jet</b>  edelstahloptik messing matt optik	<b>Bora</b>  edelstahloptik messing matt optik	<b>Tornado</b>  edelstahloptik messing matt optik
97 98	97 98	97 98	97 98

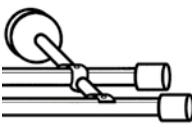
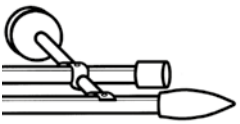
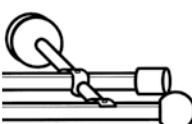
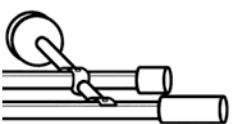

1-Lauf	Länge	Gleiter	Preis	Preis	Preis
 2713 Air	100	16	159,-	200,-	182,-
	120	18	167,-	207,-	189,-
	140	22	174,-	215,-	197,-
	160	26	181,-	223,-	205,-
	180	28	190,-	230,-	212,-
 2711 Jet	200	32	232,-	274,-	255,-
	220	34	240,-	281,-	263,-
	240	38	248,-	288,-	270,-
	260	42	255,-	297,-	278,-
	280	44	263,-	304,-	286,-
 2715 Bora	300	48	272,-	313,-	295,-
	320	50	280,-	321,-	303,-
	340	54	288,-	329,-	311,-
	360	58	295,-	336,-	318,-
	380	60	303,-	344,-	326,-
 2717 Tornado	400	64	346,-	387,-	369,-
	Preis je 20 cm		7,30	7,30	7,30
	Abschlag Wandlager je Seite		27,50	48,00	38,90
	3. Träger		ab 2,00 m	ab 2,00 m	ab 2,00 m
	4. Träger		ab 4,00 m	ab 4,00 m	ab 4,00 m

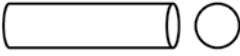
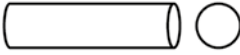
2-Lauf	Länge	Gleiter	Preis	Preis	Preis
 2714 Air	100	32	253,-	294,-	276,-
	120	36	268,-	309,-	290,-
	140	44	283,-	324,-	306,-
	160	52	298,-	339,-	321,-
	180	56	313,-	355,-	336,-
 2712 Jet	200	64	374,-	415,-	397,-
	220	68	389,-	430,-	411,-
	240	76	404,-	445,-	427,-
	260	84	419,-	460,-	442,-
	280	88	434,-	476,-	457,-
 2716 Bora	300	92	451,-	493,-	474,-
	320	100	466,-	507,-	489,-
	340	108	482,-	523,-	505,-
	360	116	496,-	537,-	519,-
	380	120	512,-	553,-	535,-
 2718 Tornado	400	128	572,-	614,-	595,-
	Preis je 20 cm		14,50	14,50	14,50
	Abschlag Wandlager je Seite		30,60	51,10	42,00
	3. Träger		ab 2,00 m	ab 2,00 m	ab 2,00 m
	4. Träger		ab 4,00 m	ab 4,00 m	ab 4,00 m

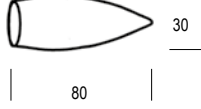
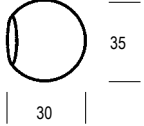
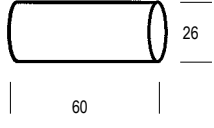
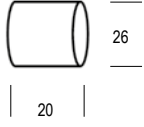
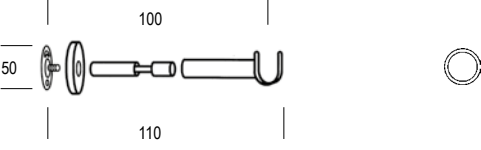
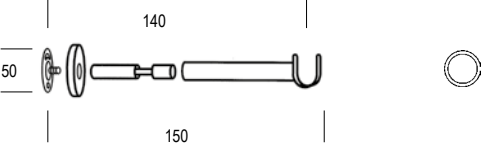

	Artikel	Oberfläche	Art.-Nr.	Preis
	<b>Metallrohr</b> 20 mm Länge: 5 m Längen m	edelstahloptik	2010097	18,10
		messing matt optik	2010098	31,50
	<b>Metallrohr</b> 20 mm Zuschnitte m	edelstahloptik	Z2010097	24,00
		messing matt optik	Z2010098	36,80
	<b>Innenlaufstange 20 mm</b> Aluminium 6 mm-Lauf Länge: 6 m Längen m	edelstahl	2000250	27,40
		messing matt	2000262	25,60
	<b>Innenlaufstange 20 mm</b> Aluminium 6 mm-Lauf Zuschnitte m	edelstahl	Z2000250	32,70
		messing matt	Z2000262	31,00
	<b>Endknopf Jet</b> Metall Stück	edelstahloptik	2031697	35,80
		messing matt optik	2031698	35,80
	<b>Endkugel Bora</b> Metall Stück	edelstahloptik	2030097	26,70
		messing matt optik	2030098	26,70
	<b>Endknopf Tornado</b> Metall Stück	edelstahloptik	2031597	26,70
		messing matt optik	2031598	26,70
	<b>Endkappe Air</b> Metall Stück	edelstahloptik	2135097	15,30
		messing matt optik	2135098	15,30
	<b>Einlegeträger Jet</b> 1-Lauf, 10 cm Metall Stück	edelstahloptik	2060497	32,70
		messing matt optik	2060498	32,70
	<b>Einlegeträger Jet</b> 1-Lauf, 14 cm Metall Stück	edelstahloptik	2030597	35,00
		messing matt optik	2030598	35,00

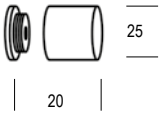
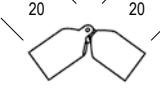
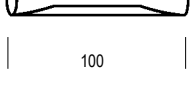
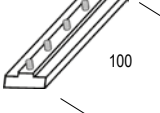
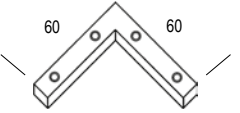
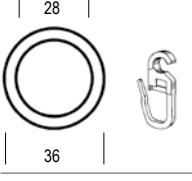
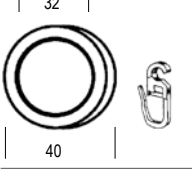
	Artikel	Oberfläche	Art.-Nr.	Preis
	<b>Einlegeträger Jet</b> <b>1-Lauf, 18 cm</b> Metall	edelstahloptik	2030897	36,30
		messing matt optik	2030898	36,30
		Stück		
	<b>Einlegeträger Jet</b> <b>2-Lauf</b> Metall	edelstahloptik	2030697	41,10
		messing matt optik	2030698	41,10
		Stück		
	<b>Träger Jet Alu</b> <b>1-Lauf, 10 cm</b> Metall	edelstahloptik	2030997	35,00
		messing matt optik	2030998	35,00
		Stück		
	<b>Träger Jet Alu</b> <b>1-Lauf, 14 cm</b> Metall	edelstahloptik	2031197	37,20
		messing matt optik	2031198	37,20
		Stück		
	<b>Träger Jet Alu</b> <b>1-Lauf, 18 cm</b> Metall	edelstahloptik	2031297	39,80
		messing matt optik	2031298	39,80
		Stück		
	<b>Träger Jet Alu</b> <b>2-Lauf</b> Metall	edelstahloptik	2031397	45,60
		messing matt optik	2031398	45,60
		Stück		
	<b>Träger Jet</b> <b>Mix</b> Metall	edelstahloptik	2031497	45,60
		messing matt optik	2031498	45,60
		Stück		
	<b>Raffhalter Jet</b> Metall	edelstahloptik	2031797	44,00
		messing matt optik	2031798	44,00
		Stück		
	<b>Verlängerung 2 cm</b> <b>für Träger</b> Metall	edelstahloptik	1652397	7,30
		messing matt optik	1652398	7,30
		Stück		

	Artikel	Oberfläche	Art.-Nr.	Preis
	<b>Wandlager</b> Metall	edelstahloptik	2145097	22,80
		messing matt optik	2145098	22,80
	<b>Erkerbogen</b> Metall	edelstahloptik	2155097	60,80
		messing matt optik	2155098	51,60
	<b>Rohrverbinder</b> Metall	verzinkt	2000107	5,40
	<b>Profilverbinder</b> Aluminium	alu blank	1520070	9,30
	<b>Profil-Eckverbinder 90°</b> Aluminium	alu blank	1521070	16,80
	<b>Ring mit Faltenhaken</b> Metall	edelstahloptik	2178297	2,00
		messing matt optik	2178298	2,00
	<b>Ring mit Faltenhaken und Gleiteinlage</b> Aluminium kantig	edelstahloptik	2578297	1,90
	<b>Faltenhaken</b> Kunststoff Öse 6 mm	glasklar	1381000	0,15
	<b>Clic-Gleiter mit Faltenhaken</b> Kunststoff für 6 mm-Lauf	weiß	2000316	0,25

20 mm | **light**

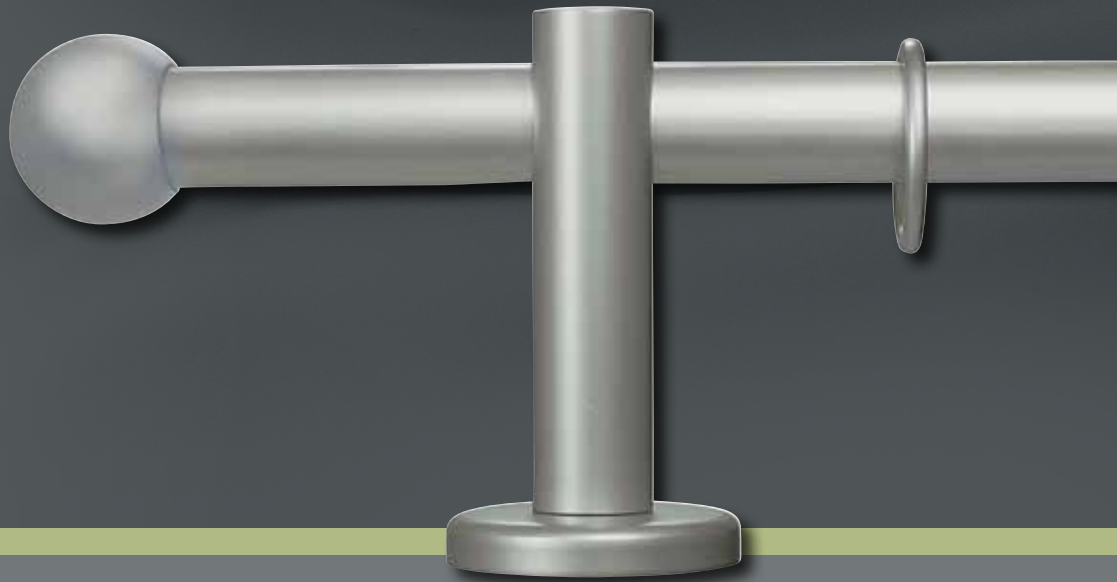



Light 2215-97



Bolos 2213-71



Cap 2217-71





97 | edelstahl-  
optik

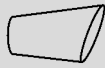

71 | alu natur

Garnituren mit Innenlauf

<b>Bolos</b>  edelstahloptik alu natur	<b>Light</b>  97 71	<b>Cap</b>  edelstahloptik alu natur	97 71
------------------------------------------------------------------------------------------------------------------------------------	-----------------------------------------------------------------------------------------------------------------	----------------------------------------------------------------------------------------------------------------------------------	----------

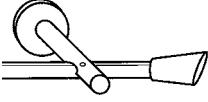
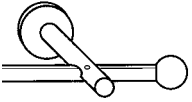
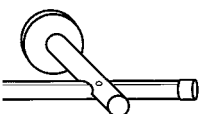
1-Lauf	Länge	Gleiter	Preis	Preis
 <b>2213 Bolos</b>	100	16	150,-	134,-
	120	18	156,-	139,-
	140	22	162,-	147,-
	160	26	168,-	153,-
	180	28	174,-	158,-
 <b>2215 Light</b>	200	32	211,-	195,-
	220	34	217,-	201,-
	240	38	223,-	207,-
	260	42	229,-	213,-
	280	44	235,-	219,-
 <b>2217 Cap</b>	300	48	243,-	226,-
	320	50	249,-	232,-
	340	54	255,-	238,-
	360	58	261,-	245,-
	380	60	268,-	251,-
	400	64	304,-	287,-
	Preis je 20 cm			6,-
Abschlag Wandlager je Seite			27,30	19,00
3. Träger			ab 2,00 m	ab 2,00 m
4. Träger			ab 4,00 m	ab 4,00 m

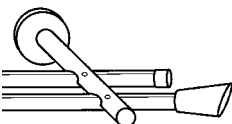
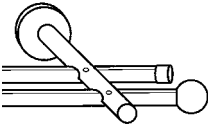
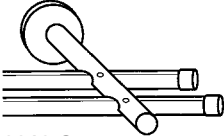
2-Lauf	Länge	Gleiter	Preis	Preis
 <b>2214 Bolos</b>	100	32	229,-	212,-
	120	36	240,-	224,-
	140	44	252,-	236,-
	160	52	264,-	247,-
	180	56	276,-	259,-
 <b>2216 Light</b>	200	64	328,-	312,-
	220	68	340,-	323,-
	240	76	352,-	335,-
	260	84	364,-	347,-
	280	88	375,-	359,-
 <b>2218 Cap</b>	300	92	389,-	373,-
	320	100	401,-	384,-
	340	108	413,-	396,-
	360	116	425,-	408,-
	380	120	436,-	420,-
	400	128	489,-	472,-
	Preis je 20 cm			12,-
Abschlag Wandlager je Seite			26,60	18,30
3. Träger			ab 2,00 m	ab 2,00 m
4. Träger			ab 4,00 m	ab 4,00 m



Bolos 2219-71



Light 2221-71

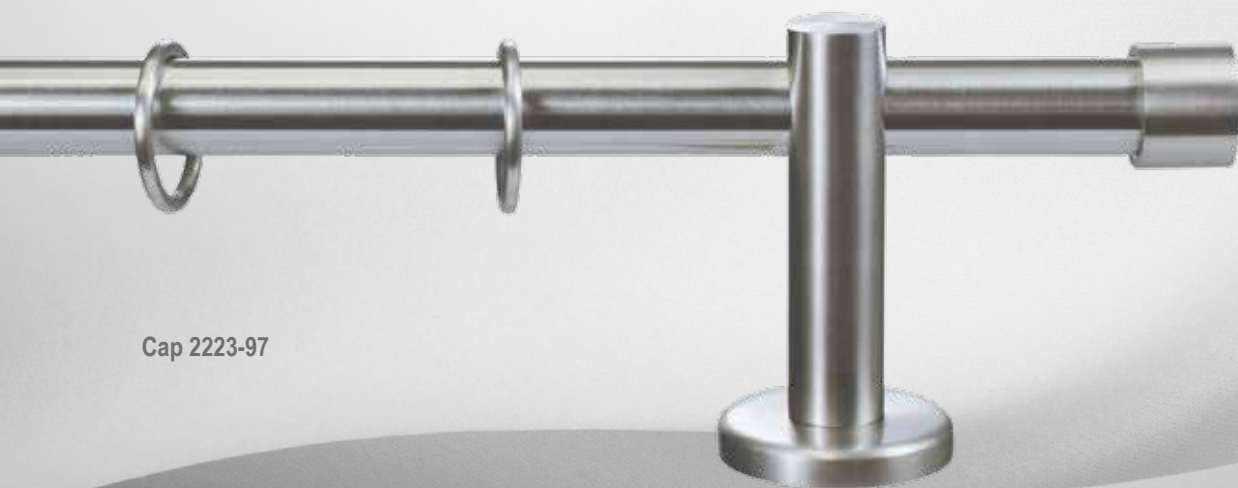



Cap 2223-97



97 | edelstahl-  
optik



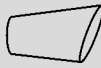

71 | alu natur

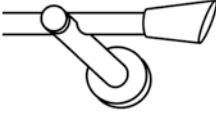
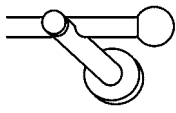
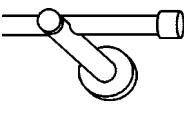

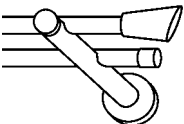
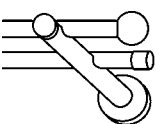
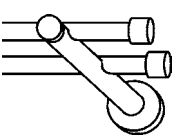
<b>Bolos</b>  edelstahloptik alu natur	<b>Light</b>  97 71	<b>Cap</b>  edelstahloptik alu natur	97 71
------------------------------------------------------------------------------------------------------------------------------------	-----------------------------------------------------------------------------------------------------------------	----------------------------------------------------------------------------------------------------------------------------------	----------



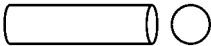
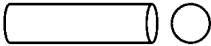

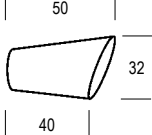
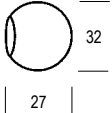
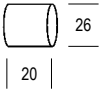
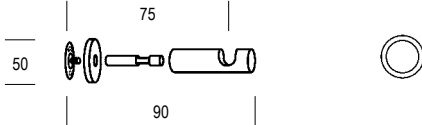
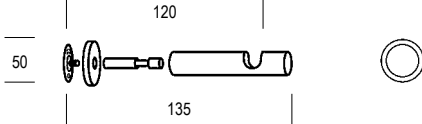
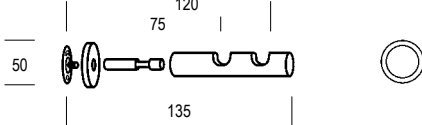
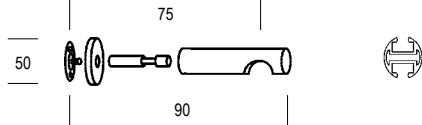

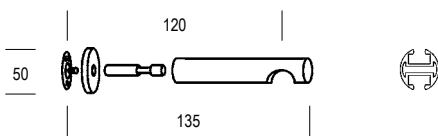
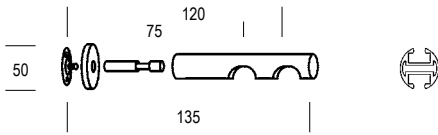
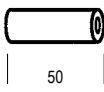
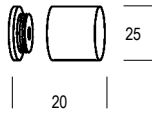

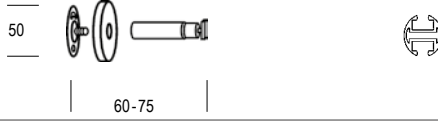
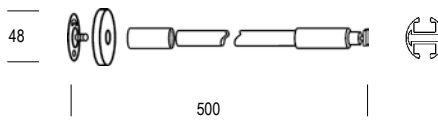
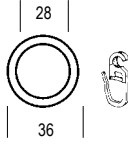
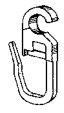
1-Lauf	Länge	Ringe	Preis	Preis	
 <b>2219 Bolos</b>	100	14	168,-	153,-	
	120	16	178,-	161,-	
	140	20	191,-	174,-	
	160	22	200,-	183,-	
	180	24	209,-	192,-	
 <b>2221 Light</b>	200	28	249,-	234,-	
	220	30	259,-	242,-	
	240	34	271,-	255,-	
	260	36	281,-	264,-	
	280	38	290,-	274,-	
 <b>2223 Cap</b>	300	42	303,-	286,-	
	320	44	312,-	295,-	
	340	48	324,-	309,-	
	360	50	334,-	317,-	
	380	52	343,-	327,-	
	400	56	384,-	367,-	
	Preis je 20 cm			9,70	9,70
	Abschlag Wandlager je Seite			25,00	16,70
3. Träger			ab 2,00 m	ab 2,00 m	
4. Träger			ab 4,00 m	ab 4,00 m	

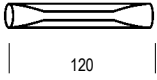
2-Lauf	Länge	Ringe	Preis	Preis	
 <b>2220 Bolos</b>	100	28	264,-	247,-	
	120	32	281,-	265,-	
	140	40	306,-	290,-	
	160	44	324,-	307,-	
	180	48	343,-	326,-	
 <b>2222 Light</b>	200	56	403,-	387,-	
	220	60	421,-	404,-	
	240	68	447,-	431,-	
	260	72	465,-	448,-	
	280	76	483,-	466,-	
 <b>2224 Cap</b>	300	84	508,-	491,-	
	320	88	526,-	510,-	
	340	96	552,-	535,-	
	360	100	569,-	553,-	
	380	104	587,-	570,-	
	400	112	649,-	632,-	
	Preis je 20 cm			18,20	18,20
	Abschlag Wandlager je Seite			21,30	13,00
3. Träger			ab 2,00 m	ab 2,00 m	
4. Träger			ab 4,00 m	ab 4,00 m	

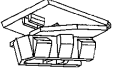
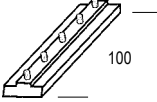

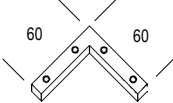
	Artikel	Oberfläche	Art.-Nr.	Preis
	<b>Metallrohr 20 mm</b>			
	Länge: 5,00 m	edelstahloptik	2010097	18,10
	Länge: 4,80 m	alu natur	2010071	15,20
	Längen m			
	<b>Metallrohr 20 mm</b>			
		edelstahloptik	Z2010097	24,00
		alu natur	Z2010071	23,40
	Zuschnitte m			
	<b>Innenlaufstange 20 mm</b>			
	Aluminium	edelstahloptik	2000297	27,40
	6 mm-Lauf	alu natur	2000271	23,90
	Länge: 6 m			
	Längen m			
	<b>Innenlaufstange 20 mm</b>			
	Aluminium	edelstahloptik	Z2000297	32,70
	6 mm-Lauf	alu natur	Z2000271	28,80
	Zuschnitte m			
	<b>Endknopf Bolos</b>			
	Metall	edelstahloptik	2260097	19,70
		alu natur	2260071	19,70
	Stück			
	<b>Endkugel Light</b>			
	Metall	edelstahloptik	2230097	19,70
		alu natur	2230071	19,70
	Stück			
	<b>Endkappe Cap</b>			
	Metall	edelstahloptik	2223097	11,40
		alu natur	2223071	11,40
	Stück			
	<b>Träger Light 1-Lauf, 8 cm</b>			
	Metall	edelstahloptik	2230197	28,10
		alu natur	2230171	28,10
	Stück			
	<b>Träger Light 1-Lauf, 12 cm</b>			
	Metall	edelstahloptik	2230397	34,10
		alu natur	2230371	34,10
	Stück			
	<b>Träger Light 2-Lauf</b>			
	Metall	edelstahloptik	2230297	35,80
		alu natur	2230271	35,80
	Stück			
	<b>Innenlaufräger Light 1-Lauf, 8 cm</b>			
	Metall	edelstahloptik	2230497	30,40
		alu natur	2230471	30,40
	Stück			

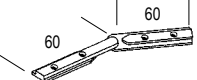
	Artikel	Oberfläche	Art.-Nr.	Preis
	<b>Innenlaufräger Light</b> <b>1-Lauf, 12 cm</b> Metall	edelstahloptik	2230597	36,50
		alu natur	2230571	36,50
	<b>Innenlaufräger Light</b> <b>2-Lauf</b> Metall	edelstahloptik	2230697	41,10
		alu natur	2230671	41,10
	<b>Trägerverlängerung 5 cm</b> Metall	edelstahloptik	2236297	14,60
		alu natur	2236271	14,60
	<b>Wandlager</b> Metall	edelstahloptik	2145097	22,80
		alu natur	2055071	25,10
	<b>Erkerbogen</b> Metall	edelstahloptik	2155097	60,80
		alu natur	2155071	60,80
	<b>Deckenträger</b> Metall 2,5 cm	edelstahloptik	2150497	26,70
		alu natur	2150471	26,70
	<b>Deckenträger</b> Metall	edelstahloptik	2140097	41,80
		alu natur	2140071	41,80
	<b>Deckenträger</b> Edelstahl 50 cm kürzbar	edelstahl	164995-116	48,00
	<b>Ring mit Faltenhaken</b> Metall	edelstahloptik	2178297	2,00
		alu natur	2178271	2,00
	<b>Faltenhaken</b> Kunststoff Öse 6 mm	glasklar	1381000	0,15

		Artikel	Oberfläche	Art.-Nr.	Preis
		<b>Rohrverbinder</b>	verzinkt	2000107	5,40
		Metall			
		Stück			
		<b>Clic-Gleiter mit Faltenhaken</b>	weiß	2000316	0,25
		Kunststoff für 6 mm-Lauf			
		Stück			
		<b>End- und Zwischenfeststeller</b>	glasklar	2000516	0,30
		Kunststoff für 6 mm-Lauf			
		Stück			
		<b>Profilverbinder</b>	alu blank	1520070	9,30
		Aluminium			
		Stück			
		<b>Profil-Eckverbinder 90°</b>	alu blank	1521070	16,80
		Aluminium			
		Stück			
		<b>Eckverbinder 90°-180°</b>	alu blank	1520371	24,00
		Aluminium			
		Stück			

20 mm | **casa**

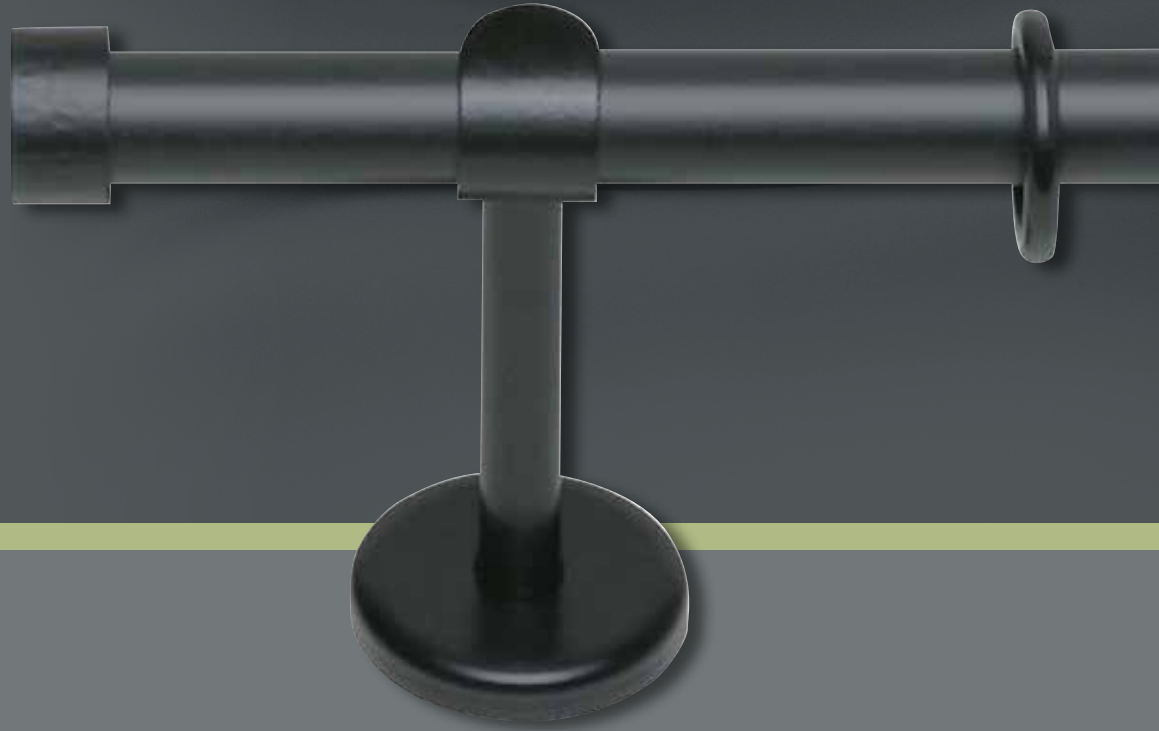



Jana 2727-13

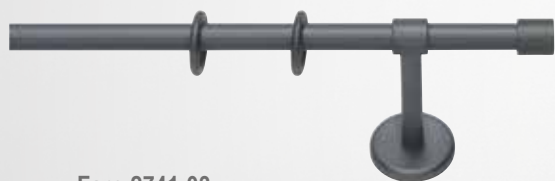

Faro 2741-03

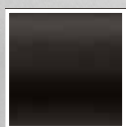

13 | schwarz



03 | graphit

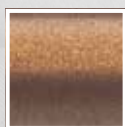

04 | bronze



25 | chrom matt

schwarz	13	graphit	03
		bronze	04
		chrom matt	25

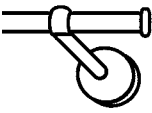
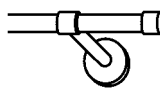
1-Lauf	Länge	Ringe	Preis	Preis
	100	14	121,-	150,-
	120	16	125,-	156,-
	140	20	128,-	166,-
	160	22	132,-	173,-
	180	24	134,-	179,-
<b>2727 Jana</b> (Einlegeträger)	200	28	168,-	220,-
	220	30	172,-	228,-
	240	34	176,-	237,-
	260	36	180,-	243,-
	280	38	182,-	251,-
	300	42	185,-	259,-
	320	44	188,-	266,-
	340	48	192,-	275,-
	360	50	195,-	282,-
	380	52	199,-	288,-
<b>2741 Faro</b> (geschl. Träger)	400	56	232,-	330,-
<b>2745 Faro</b> (Einlegeträger)	Preis je 20 cm		3,60	7,20
	Abschlag Wandlager je Seite		19,90	21,30
		3. Träger	ab 2,00 m	ab 2,00 m
		4. Träger	ab 4,00 m	ab 4,00 m

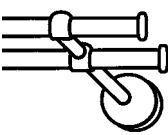
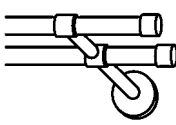
2-Lauf	Länge	Ringe	Preis	Preis
	100	28	195,-	248,-
	120	32	202,-	261,-
	140	40	209,-	281,-
	160	44	215,-	294,-
	180	48	223,-	307,-
<b>2728 Jana</b> (Einlegeträger)	200	56	272,-	372,-
	220	60	280,-	385,-
	240	68	287,-	403,-
	260	72	293,-	416,-
	280	76	300,-	431,-
	300	84	306,-	448,-
	320	88	313,-	461,-
	340	96	321,-	480,-
	360	100	328,-	493,-
	380	104	334,-	507,-
<b>2742 Faro</b> (geschl. Träger)	400	112	385,-	571,-
<b>2746 Faro</b> (Einlegeträger)	Preis je 20 cm		6,10	13,30
	Abschlag Wandlager je Seite		22,90	23,60
		3. Träger	ab 2,00 m	ab 2,00 m
		4. Träger	ab 4,00 m	ab 4,00 m



Casa 2731-03



Taja 2019-04



Jova 2729-04

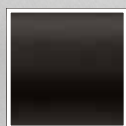

13 | schwarz



03 | graphit

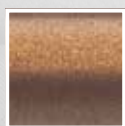







04 | bronze

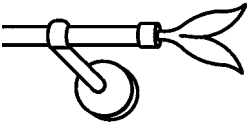
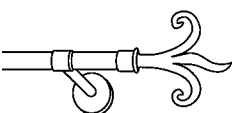
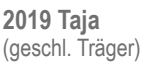
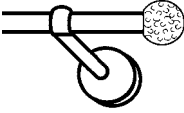

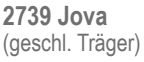

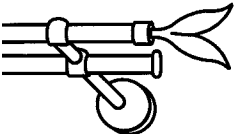
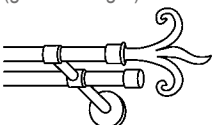
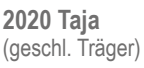
25 | chrom matt

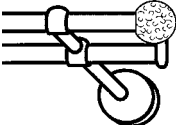
schwarz	13	graphit	03
		bronze	04
		chrom matt	25

1-Lauf	Länge	Ringe	Preis	Preis
 <b>2731 Casa</b> (Einlegeträger)	100	14	145,-	174,-
	120	16	149,-	180,-
	140	20	153,-	190,-
	160	22	156,-	197,-
	180	24	159,-	203,-
 <b>2735 Casa</b> (geschl. Träger)	200	28	192,-	246,-
	220	30	196,-	252,-
	240	34	200,-	261,-
	260	36	203,-	268,-
	280	38	206,-	275,-
 <b>2019 Taja</b> (geschl. Träger)	300	42	209,-	283,-
	320	44	212,-	290,-
	340	48	217,-	299,-
 <b>2749 Taja</b> (Einlegeträger)	360	50	219,-	306,-
	380	52	223,-	313,-
	400	56	257,-	355,-
	Preis je 20 cm		3,60	7,20
 <b>2729 Jova</b> (Einlegeträger)	Abschlag Wandlager je Seite		32,00	33,50
		3. Träger	ab 2,00 m	ab 2,00 m
 <b>2739 Jova</b> (geschl. Träger)		4. Träger	ab 4,00 m	ab 4,00 m

2-Lauf	Länge	Ringe	Preis	Preis
 <b>2732 Casa</b> (Einlegeträger)	100	28	219,-	272,-
	120	32	226,-	286,-
	140	40	234,-	305,-
	160	44	240,-	318,-
	180	48	247,-	332,-
 <b>2736 Casa</b> (geschl. Träger)	200	56	297,-	396,-
	220	60	304,-	409,-
	240	68	311,-	427,-
	260	72	318,-	442,-
	280	76	324,-	455,-
 <b>2020 Taja</b> (geschl. Träger)	300	84	330,-	472,-
	320	88	338,-	485,-
	340	96	345,-	505,-
 <b>2750 Taja</b> (Einlegeträger)	360	100	352,-	518,-
	380	104	358,-	531,-
	400	112	409,-	595,-
	Preis je 20 cm		6,10	13,30
 <b>2730 Jova</b> (Einlegeträger)	Abschlag Wandlager je Seite		35,00	35,80
		3. Träger	ab 2,00 m	ab 2,00 m
 <b>2740 Jova</b> (geschl. Träger)		4. Träger	ab 4,00 m	ab 4,00 m

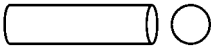
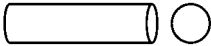

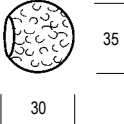
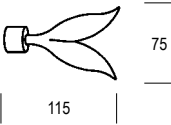
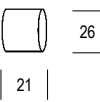
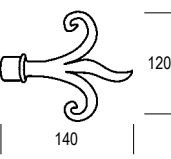
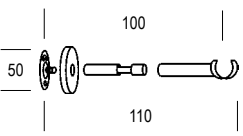
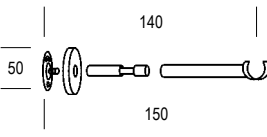
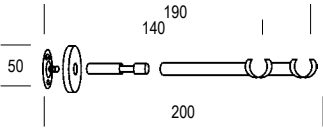
	Artikel	Oberfläche	Art.-Nr.	Preis
	<b>Stahlrohr 20 mm</b> Länge: 5,00 m  Längen m	schwarz	2010013	15,40
		graphit	2010003	19,70
		bronze	2010004	19,70
		chrom matt	2010025	19,70
	<b>Stahlrohr 20 mm</b>  Zuschnitte m	schwarz	Z2010013	18,00
		graphit	Z2010003	25,10
		bronze	Z2010004	25,10
		chrom matt	Z2010025	25,10
	<b>Endkappe Jana</b> Metall  Stück	schwarz	2022113	13,00
		graphit	2022103	14,50
		bronze	2022104	14,50
		chrom matt	2022125	14,50
	<b>Endkugel Jova</b> Metall  Stück	schwarz	2022213	25,10
		graphit	2022203	26,70
		bronze	2022204	26,70
		chrom matt	2022225	26,70
	<b>Endknopf Casa</b> Metall  Stück	schwarz	2022313	25,10
		graphit	2022303	26,70
		bronze	2022304	26,70
		chrom matt	2022325	26,70
	<b>Endkappe Faro</b> Metall  Stück	schwarz	2023013	19,75
	<b>Endknopf Taja</b> Metall  Stück	schwarz	2020313	25,10
		graphit	2020303	26,70
		bronze	2020304	26,70
		chrom matt	2020325	26,70
	<b>Einlegeträger</b> <b>1-Lauf, 10 cm</b> Metall  Stück	schwarz	2060413	29,70
		graphit	2060403	31,90
		bronze	2060404	31,90
		chrom matt	2060425	31,90
	<b>Einlegeträger</b> <b>1-Lauf, 14 cm</b> Metall  Stück	schwarz	2030513	32,70
		graphit	2030503	35,00
		bronze	2030504	35,00
		chrom matt	2030525	35,00
	<b>Einlegeträger</b> <b>2-Lauf</b> Metall  Stück	schwarz	2030613	42,50
		graphit	2030603	44,80
		bronze	2030604	44,80
		chrom matt	2030625	44,80

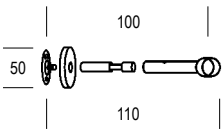
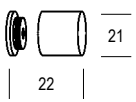
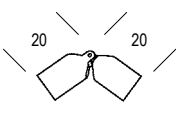
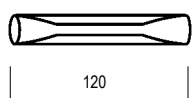
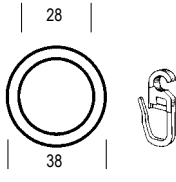
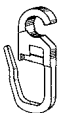
	Artikel	Oberfläche	Art.-Nr.	Preis	
	<b>Träger Orion</b> 1-Lauf, 10 cm Metall Stück	schwarz	2053013	29,70	
		graphit	2053003	31,90	
		bronze	2053004	31,90	
		chrom matt	2053025	31,90	
	<b>Wandlager</b> Metall Stück	schwarz	2055013	22,80	
		graphit	2055003	25,10	
		bronze	2055004	25,10	
		chrom matt	2055025	25,10	
	<b>Erkergelenk</b> Metall für 20 mm-Rohr Stück	schwarz	2155013	63,00	
		graphit	2155003	65,30	
		bronze	2155004	65,30	
		chrom matt	2155025	65,30	
	<b>Rohrverbinder</b> Metall Stück	verzinkt	2000107	5,40	
	<b>Ring mit Faltenhaken</b> Kunststoff Stück	schwarz	1878213	0,27	
		graphit	1878203	1,50	
		bronze	1878204	1,50	
		chrom matt	1878225	1,50	
	<b>Faltenhaken</b> Kunststoff Öse 6 mm Stück	schwarz	1281013	0,15	
		silberfarbig	1281025	0,15	
		goldfarbig	1281075	0,15	
		braun	1281004	0,15	

20 mm | **classic**

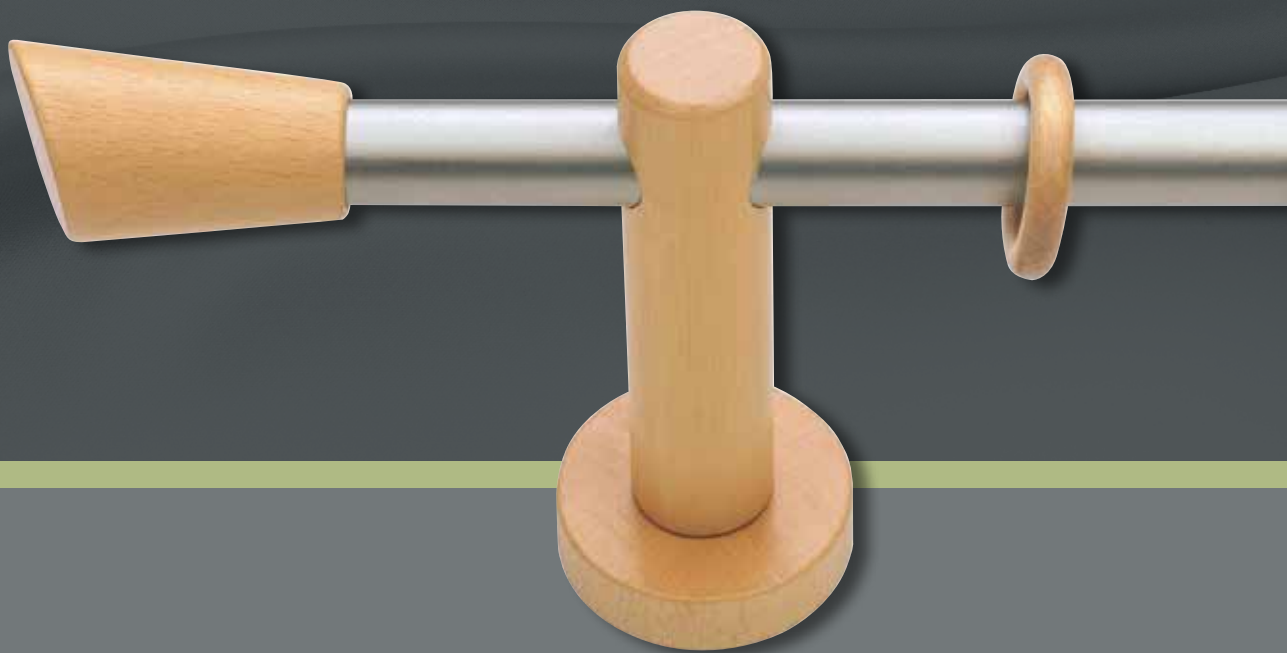



Milos 2001-02



Agros 2003-08



02 | natur



08 | kirschbaum



25 | chrom matt



75 | gold matt



54 | chrom matt /  
natur



56 | chrom matt /  
nussbaum



13 | schwarz



06 | weiß

natur kirschbaum	02 08	chrom matt gold matt	25 75	chrom matt/ natur chrom matt/ nussbaum	54 56	schwarz weiß	13 06
---------------------	----------	-------------------------	----------	-------------------------------------------------	----------	-----------------	----------

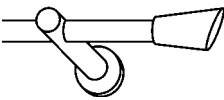
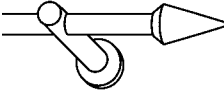
1-Lauf	Länge	Ringe	Preis	Preis	Preis	Preis	
 <p>2001 Milos</p>	100	14	91,-	93,-	93,-	88,-	
	120	16	97,-	99,-	99,-	94,-	
	140	20	102,-	104,-	104,-	99,-	
	160	22	107,-	109,-	109,-	104,-	
	180	24	112,-	114,-	114,-	109,-	
 <p>2003 Agros</p>	200	28	131,-	133,-	133,-	128,-	
	220	30	136,-	138,-	138,-	133,-	
	240	34	141,-	143,-	143,-	138,-	
	260	36	144,-	146,-	146,-	139,-	
	280	38	150,-	152,-	152,-	147,-	
	300	42	154,-	156,-	156,-	149,-	
	320	44	160,-	162,-	162,-	157,-	
	340	48	164,-	166,-	166,-	161,-	
	360	50	184,-	186,-	176,-	181,-	
	380	52	189,-	190,-	190,-	186,-	
	400	56	194,-	195,-	195,-	191,-	
	Preis je 20 cm			5,-	5,-	5,-	5,-
	Abschlag Wandlager je Seite			13,00	13,00	13,00	13,00
	3. Träger			ab 2,00 m	ab 2,00 m	ab 2,00 m	ab 2,00 m
	4. Träger			ab 3,60 m	ab 3,60 m	ab 3,60 m	ab 3,60 m

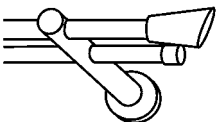
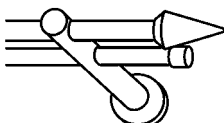
2-Lauf	Länge	Ringe	Preis	Preis	Preis	Preis	
 <p>2002 Milos</p>	100	28	136,-	138,-	138,-	133,-	
	120	32	144,-	146,-	146,-	141,-	
	140	40	155,-	157,-	157,-	152,-	
	160	44	165,-	167,-	167,-	162,-	
	180	48	175,-	177,-	177,-	172,-	
 <p>2004 Agros</p>	200	56	201,-	203,-	203,-	198,-	
	220	60	210,-	212,-	212,-	207,-	
	240	68	221,-	223,-	223,-	218,-	
	260	72	230,-	232,-	232,-	227,-	
	280	76	240,-	242,-	242,-	237,-	
	300	84	248,-	250,-	250,-	245,-	
	320	88	258,-	260,-	260,-	255,-	
	340	96	268,-	270,-	270,-	265,-	
	360	100	293,-	295,-	295,-	290,-	
	380	104	302,-	304,-	304,-	299,-	
	400	112	313,-	315,-	315,-	310,-	
	Preis je 20 cm			10,-	10,-	10,-	10,-
	Abschlag Wandlager je Seite			13,00	13,00	13,00	13,00
	3. Träger			ab 2,00 m	ab 2,00 m	ab 2,00 m	ab 2,00 m
	4. Träger			ab 3,60 m	ab 3,60 m	ab 3,60 m	ab 3,60 m

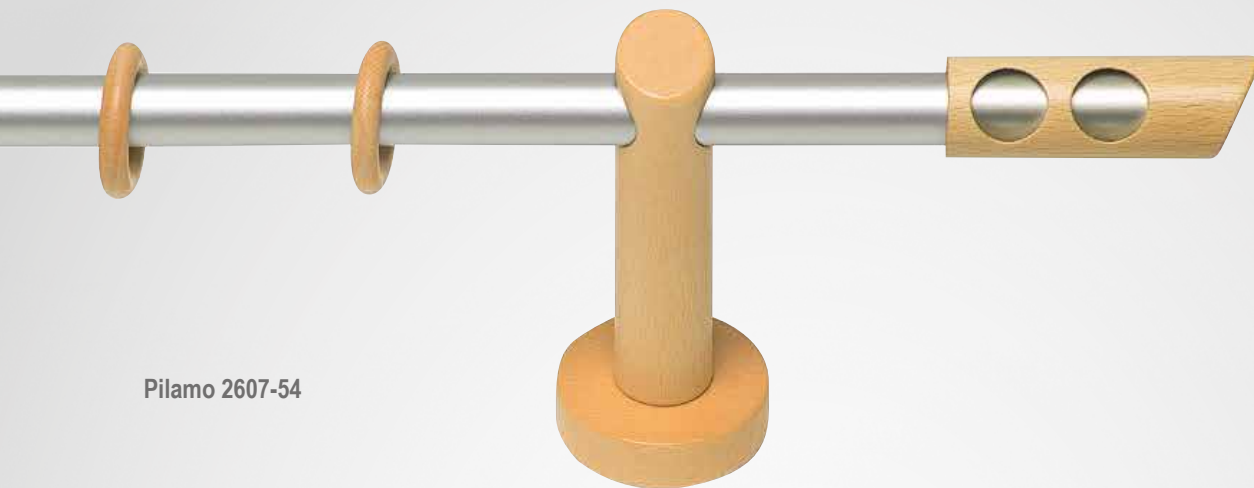

Pilamo 2607-54



Pempia 2611-56



Pandorra 2609-25



25 | chrom matt



02 | natur



54 | chrom matt /  
natur



56 | chrom matt /  
nussbaum

natur	02
chrom matt	25
chrom matt / natur	54
chrom matt / nussbaum	56

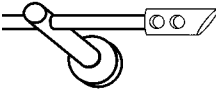
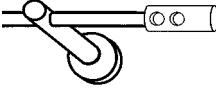
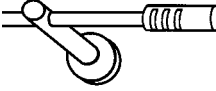
1-Lauf	Länge	Ringe	Preis
 <p>2607 Pilamo</p>	100	14	98,-
	120	16	104,-
	140	20	109,-
	160	22	114,-
	180	24	119,-
 <p>2609 Pandora</p>	200	28	138,-
	220	30	143,-
	240	34	148,-
	260	36	151,-
	280	38	157,-
 <p>2611 Pempia</p>	300	42	161,-
	320	44	167,-
	340	48	171,-
	360	50	190,-
	380	52	195,-
	400	56	200,-
Preis je 20 cm			4,80
Abschlag Wandlager je Seite			16,90
3. Träger			ab 2,00 m
4. Träger			ab 3,60 m

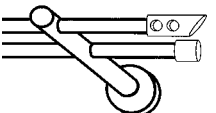
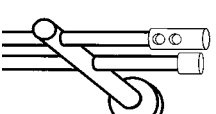
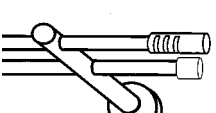
2-Lauf	Länge	Ringe	Preis
 <p>2608 Pilamo</p>	100	28	143,-
	120	32	151,-
	140	40	162,-
	160	44	172,-
	180	48	182,-
 <p>2610 Pandora</p>	200	56	208,-
	220	60	217,-
	240	68	228,-
	260	72	237,-
	280	76	247,-
 <p>2612 Pempia</p>	300	84	255,-
	320	88	265,-
	340	96	275,-
	360	100	300,-
	380	104	309,-
	400	112	320,-
Preis je 20 cm			9,70
Abschlag Wandlager je Seite			13,20
3. Träger			ab 2,00 m
4. Träger			ab 3,60 m



Rom 2087-25



Kea 2089-08



02 | natur



08 | kirschbaum



25 | chrom matt



75 | gold matt

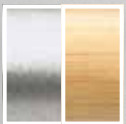

54 | chrom matt /  
natur



56 | chrom matt /  
nussbaum



13 | schwarz



06 | weiß

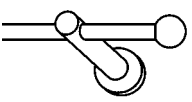
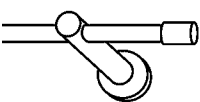

natur kirschbaum	02 08	chrom matt gold matt	25 75	chrom matt/ natur chrom matt/ nussbaum	54 56	schwarz weiß	13 06
---------------------	----------	-------------------------	----------	-------------------------------------------------	----------	-----------------	----------

1-Lauf	Länge	Ringe	Preis	Preis	Preis	Preis	
 <p>2087 Rom</p>	100	14	86,-	91,-	91,-	86,-	
	120	16	92,-	97,-	97,-	92,-	
	140	20	97,-	102,-	102,-	97,-	
	160	22	102,-	107,-	107,-	102,-	
	180	24	107,-	112,-	112,-	107,-	
 <p>2089 Kea</p>	200	28	126,-	131,-	131,-	126,-	
	220	30	131,-	136,-	136,-	131,-	
	240	34	136,-	141,-	141,-	136,-	
	260	36	140,-	144,-	144,-	140,-	
	280	38	145,-	150,-	150,-	145,-	
	300	42	150,-	154,-	154,-	150,-	
	320	44	155,-	160,-	160,-	155,-	
	340	48	160,-	164,-	164,-	160,-	
	360	50	180,-	184,-	184,-	180,-	
	380	52	185,-	189,-	189,-	185,-	
	400	56	190,-	194,-	194,-	190,-	
	Preis je 20 cm			5,-	5,-	5,-	5,-
	Abschlag Wandlager je Seite			13,00	13,00	13,00	13,00
	3. Träger			ab 2,00 m	ab 2,00 m	ab 2,00 m	ab 2,00 m
	4. Träger			ab 3,60 m	ab 3,60 m	ab 3,60 m	ab 3,60 m

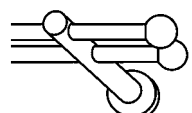
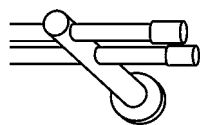
2-Lauf	Länge	Ringe	Preis	Preis	Preis	Preis	
 <p>2088 Rom</p>	100	28	131,-	138,-	138,-	131,-	
	120	32	139,-	146,-	146,-	139,-	
	140	40	150,-	157,-	157,-	150,-	
	160	44	160,-	167,-	167,-	160,-	
	180	48	170,-	177,-	177,-	170,-	
 <p>2090 Kea</p>	200	56	196,-	203,-	203,-	196,-	
	220	60	205,-	212,-	212,-	205,-	
	240	68	216,-	223,-	223,-	216,-	
	260	72	225,-	232,-	232,-	225,-	
	280	76	235,-	242,-	242,-	235,-	
	300	84	243,-	250,-	250,-	243,-	
	320	88	253,-	260,-	260,-	253,-	
	340	96	263,-	270,-	270,-	263,-	
	360	100	290,-	295,-	295,-	290,-	
	380	104	300,-	304,-	304,-	300,-	
	400	112	310,-	315,-	315,-	310,-	
	Preis je 20 cm			10,-	10,-	10,-	10,-
	Abschlag Wandlager je Seite			13,00	13,00	13,00	13,00
	3. Träger			ab 2,00 m	ab 2,00 m	ab 2,00 m	ab 2,00 m
	4. Träger			ab 3,60 m	ab 3,60 m	ab 3,60 m	ab 3,60 m



Pilamo 2619-25



Pandorra 2621-54



Pempia 2623-56



25 | chrom matt



54 | chrom matt /  
natur

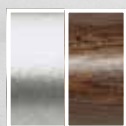

56 | chrom matt /  
nussbaum

chrom matt	25
chrom matt / natur	54
chrom matt / nussbaum	56

Garnituren mit Innenlauf

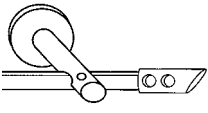
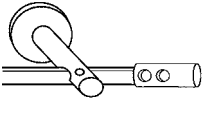
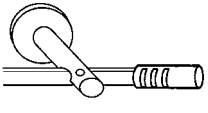
1-Lauf	Länge	Gleiter	Preis
 2619 Pilamo	100	16	107,-
	120	18	110,-
	140	22	113,-
	160	26	116,-
	180	28	119,-
 2621 Pandorra	200	32	123,-
	220	34	151,-
	240	38	154,-
	260	42	157,-
	280	44	160,-
 2623 Pempia	300	48	164,-
	320	50	167,-
	340	54	170,-
	360	58	198,-
	380	60	201,-
	400	64	204,-
Preis je 20 cm			3,-
Abschlag Wandlager je Seite			20,80
3. Träger			ab 2,20 m
4. Träger			ab 3,60 m

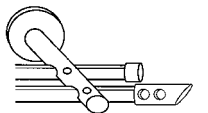
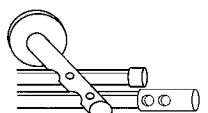
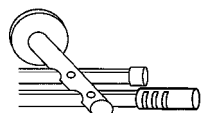
2-Lauf	Länge	Gleiter	Preis
 2620 Pilamo	100	32	139,-
	120	36	145,-
	140	44	151,-
	160	52	157,-
	180	56	162,-
 2622 Pandorra	200	64	169,-
	220	68	201,-
	240	76	207,-
	260	84	213,-
	280	88	218,-
 2624 Pempia	300	96	225,-
	320	100	231,-
	340	108	237,-
	360	116	269,-
	380	120	275,-
	400	128	281,-
Preis je 20 cm			6,-
Abschlag Wandlager je Seite			16,90
3. Träger			ab 2,20 m
4. Träger			ab 3,60 m



Rom 2091-13



Kea 2093-25



25 | chrom matt



75 | gold matt

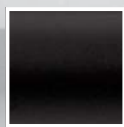

13 | schwarz



06 | weiß



54 | chrom matt /  
natur



02 | beige /  
natur





38 | chrom matt /  
schwarz



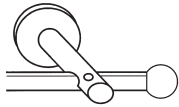

56 | chrom matt /  
nussbaum

beige/natur	02	schwarz	13
chrom matt/		chrom matt	25
natur	54	gold matt	75
chrom matt/		weiß	06
nussbaum	56	chrom matt/	
		schwarz	38

### Garnituren mit Innenlauf

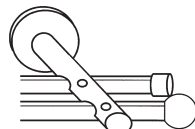
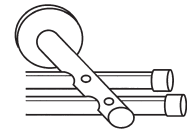
1-Lauf	Länge	Gleiter	Preis	Preis
 <p>2091 Rom</p>	100	16		
	120	18		
	140	22		
	160	26		
	180	28		
 <p>2093 Kea</p>	200	32		
	220	34		
	240	38		
	260	42		
	280	44		
	300	48		
	320	50		
	340	54		
	360	58		
	380	60		
	400	64		
		Preis je 20 cm		
		Abschlag Wandlager je Seite		
		3. Träger	ab 2,00 m	ab 2,00 m
		4. Träger	ab 4,00 m	ab 4,00 m

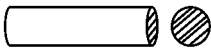
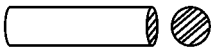
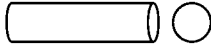
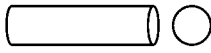

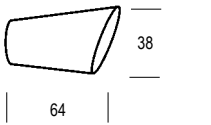
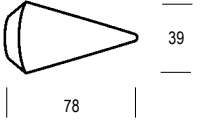
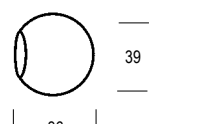

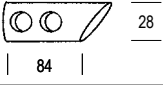
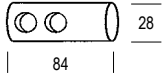
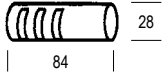
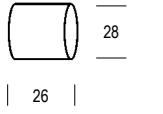
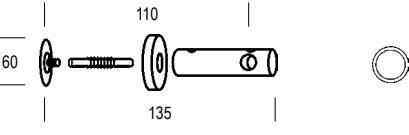
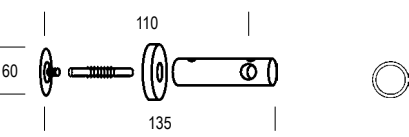
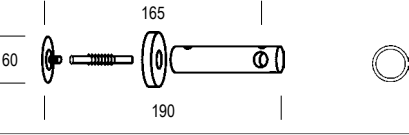
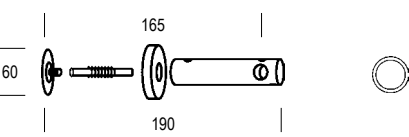
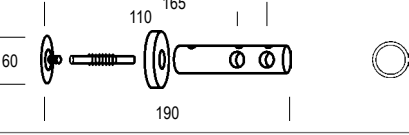
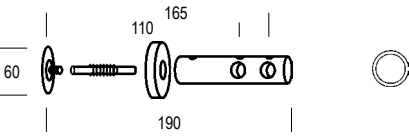
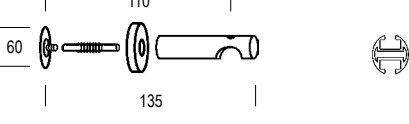
2-Lauf	Länge	Gleiter	Preis	Preis
 <p>2092 Rom</p>	100	32		
	120	36		
	140	44		
	160	52		
	180	56		
 <p>2094 Kea</p>	200	64		
	220	68		
	240	76		
	260	84		
	280	88		
	300	96		
	320	100		
	340	108		
	360	116		
	380	120		
	400	128		
		Preis je 20 cm		
		Abschlag Wandlager je Seite		
		3. Träger	ab 2,00 m	ab 2,00 m
		4. Träger	ab 4,00 m	ab 4,00 m

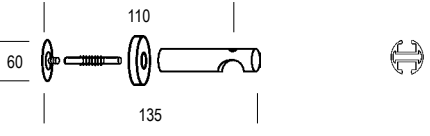
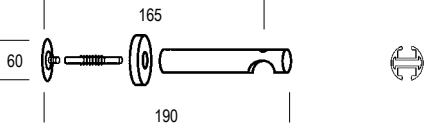
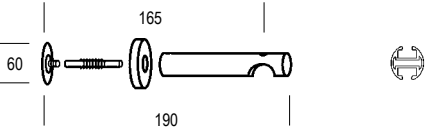
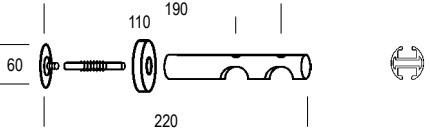
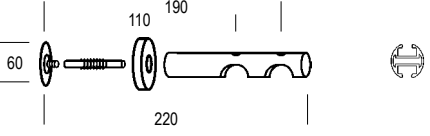
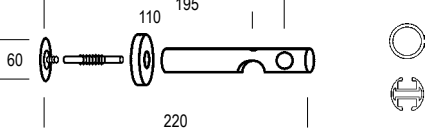
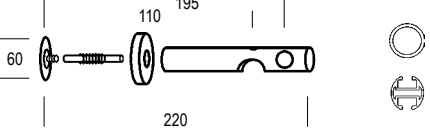
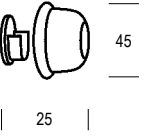
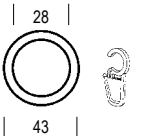
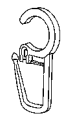
	Artikel	Oberfläche	Art.-Nr.	Preis
	<b>Holzstange 20 mm</b> Länge: ca. 4,30 m	natur	2000002	10,80
		kirschbaum	2000008	10,80
		rotbuche	2000074	10,80
		Längen m		
	<b>Holzstange 20 mm</b>	natur	Z2000002	16,80
		kirschbaum	Z2000008	16,80
		rotbuche	Z2000074	16,80
		Zuschnitte m		
	<b>Stahlrohr 20 mm</b> Länge: 5,00 m	schwarz	2010013	15,40
		chrom matt	2010025	19,70
		gold matt	2010075	19,40
		weiß	2010006	12,90
Längen m				
	<b>Stahlrohr 20 mm</b>	schwarz	Z2010013	18,25
		chrom matt	Z2010025	25,10
		gold matt	Z2010075	25,50
		weiß	Z2010006	15,30
Zuschnitte m				
	<b>Innenlaufstange 20 mm</b> Aluminium 6 mm-Lauf Länge: 6 m Längen m	beige	2000203	23,90
		schwarz	2000213	23,90
		chrom matt	2000225	23,90
		gold matt	2000275	23,90
		weiß	2000206	23,90
	<b>Innenlaufstange 20 mm</b> Aluminium 6 mm-Lauf Zuschnitte m	beige	Z2000203	28,80
		schwarz	Z2000213	28,80
		chrom matt	Z2000225	28,80
		gold matt	Z2000275	28,80
		weiß	Z2000206	28,80
	<b>Endknopf Milos</b> Holz	natur	2032002	9,00
		kirschbaum	2032008	9,00
		nussbaum	2032004	9,00
		schwarz	2032013	9,00
		weiß	2032006	9,00
		Stück		
	<b>Endknopf Agros</b> Holz	natur	2033002	9,00
		kirschbaum	2033008	9,00
		nussbaum	2033004	9,00
		schwarz	2033013	9,00
		weiß	2033006	9,00
		Stück		
	<b>Endkugel Rom</b> Holz	natur	2030002	5,90
		kirschbaum	2030008	5,90
		nussbaum	2030004	5,90
		schwarz	2030013	5,90
		weiß	2030006	5,90
		Stück		

	Artikel	Oberfläche	Art.-Nr.	Preis	
	<b>Endknopf Pilamo</b>	natur	2620102	12,40	
	Holz	nussbaum	2620104	12,40	
	Stück	chrom matt	2620125	12,40	
	<b>Endknopf Pandora</b>	natur	2620302	12,40	
	Holz	nussbaum	2620304	12,40	
	Stück	chrom matt	2620325	12,40	
	<b>Endknopf Pempia</b>	natur	2620502	12,40	
	Holz	nussbaum	2620504	12,40	
	Stück	chrom matt	2620525	12,40	
	<b>Endkappe Kea</b>	natur	2031002	5,00	
	Holz	kirschbaum	2031008	5,00	
		nussbaum	2031004	5,00	
		schwarz	2031013	5,00	
		chrom matt	2031025	5,00	
		gold matt	2031075	5,00	
		weiß	2031006	5,00	
Stück					
	<b>Träger Kos</b>	natur	2035002	15,00	
	<b>1-Lauf, 12 cm</b>	nussbaum	2035004	15,00	
	<b>Träger Kos</b> <b>1-Lauf, 12 cm</b>	schwarz	2035013	15,00	
		Kunststoff/Holz	chrom matt	2035025	15,00
		weiß	2035006	15,00	
Stück					
	<b>Träger Kos</b>	natur	2038002	17,00	
	<b>1-Lauf, 18 cm</b>	nussbaum	2038004	17,00	
	<b>Träger Kos</b> <b>1-Lauf, 18 cm</b>	schwarz	2038013	17,00	
		Kunststoff/Holz	chrom matt	2038025	17,00
		weiß	2038006	17,00	
Stück					
	<b>Träger Kos</b>	natur	2036002	16,80	
	<b>2-Lauf</b>	nussbaum	2036004	16,80	
	<b>Träger Kos</b> <b>2-Lauf</b>	schwarz	2036013	16,80	
		Kunststoff/Holz	chrom matt	2036025	16,80
		weiß	2036006	16,80	
Stück					
	<b>Träger Classic Alu</b>	natur	2001002	18,90	
	<b>1-Lauf, 12 cm</b>	nussbaum	2001004	18,90	
Holz					
Stück					

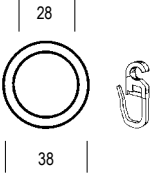
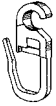
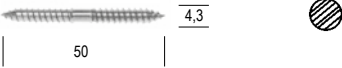
	Artikel	Oberfläche	Art.-Nr.	Preis
	<b>Träger Classic Alu</b> <b>1-Lauf, 12 cm</b> Kunststoff/Holz Stück	schwarz	2001013	18,90
		chrom matt	2001025	18,90
		weiß	2001006	18,90
	<b>Träger Classic Alu</b> <b>1-Lauf, 18 cm</b> Holz Stück	natur	2001102	19,60
		nussbaum	2001104	19,60
	<b>Träger Classic Alu</b> <b>1-Lauf, 18 cm</b> Kunststoff/Holz Stück	schwarz	2001113	19,60
		chrom matt	2001125	19,60
		weiß	2001106	19,60
	<b>Träger Classic Alu</b> <b>2-Lauf</b> Holz Stück	natur	2001202	20,50
		nussbaum	2001204	20,50
	<b>Träger Classic Alu</b> <b>2-Lauf</b> Kunststoff/Holz Stück	schwarz	2001213	20,50
		chrom matt	2001225	20,50
		weiß	2001206	20,50
	<b>Träger Mix</b> <b>2-Lauf</b> Holz Stück	natur	2001502	17,00
		nussbaum	2001504	17,00
	<b>Träger Mix</b> <b>2-Lauf</b> Kunststoff/Holz Stück	schwarz	2001513	17,00
		chrom matt	2001525	17,00
		weiß	2001506	17,00
	<b>Wandlager</b> Holz	natur	2045002	10,50
		kirschbaum	2045008	10,50
		rotbuche	2045074	10,50
		schwarz	2045013	10,50
		chrom matt	2045025	10,50
		weiß	2045006	10,50
	<b>Ring mit Faltenhaken</b> Holz Stück	natur	2078202	0,55
		kirschbaum	2078208	0,55
		nussbaum	2078204	0,55
	<b>Faltenhaken</b> Kunststoff Öse 10 mm Stück	glasklar	2881000	0,15
		natur	2881002	0,15

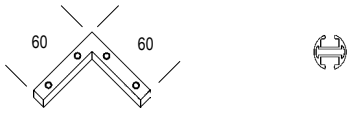
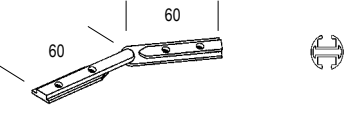

	Artikel	Oberfläche	Art.-Nr.	Preis
 <p>28</p> <p>38</p>	<b>Ring mit Faltenhaken</b>	schwarz	1878213	0,27
	Kunststoff	chrom matt	1878225	1,40
		weiß	1878206	0,27
	Stück			
	<b>Faltenhaken</b>	schwarz	1281013	0,15
	Kunststoff	silberfarbig	1281025	0,15
	Öse 6 mm	weiß	1281006	0,15
	Stück			
 <p>50</p> <p>4,3</p>	<b>Holzstangen-Verbinder</b>	verzinkt	2923510	2,09
	Metall Holzgewinde beidseitig			
 <p>120</p>	<b>Rohrverbinder</b>	verzinkt	2000107	5,40
	Metall			
 <p>100</p>	<b>Profilverbinder</b>	alu blank	1520070	9,30
	Aluminium			
 <p>60</p> <p>60</p>	<b>Profil-Eckverbinder 90°</b>	alu blank	1521070	16,80
	Aluminium			
 <p>60</p> <p>60</p> <p>60</p>	<b>Profil-Eckverbinder 60°-180°</b>	alu blank	1520371	24,00
	Aluminium			
	<b>Clic-Gleiter mit Faltenhaken</b>	weiß	2000316	0,25
	Kunststoff für 6 mm-Lauf			
	<b>End- und Zwischenfeststeller</b>	glasklar	2000516	0,30
	Kunststoff für 6 mm-Lauf			
	Stück			

20 mm | **basic**

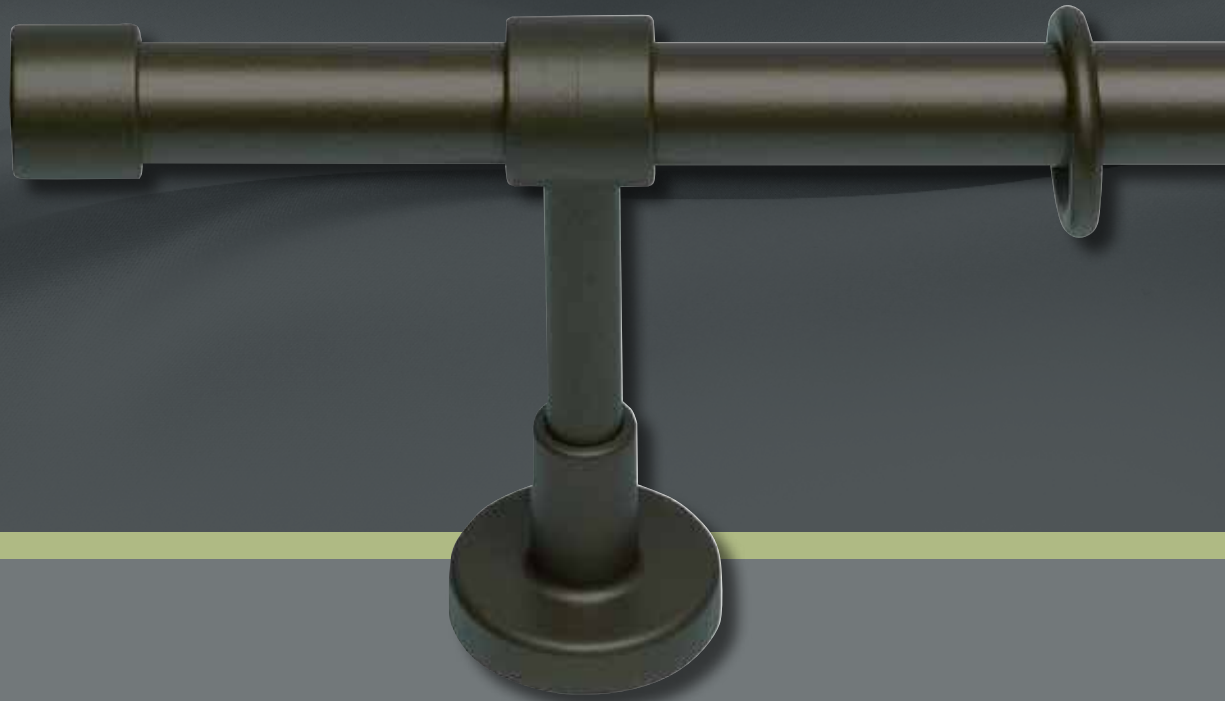

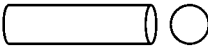
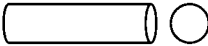
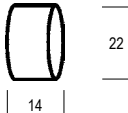
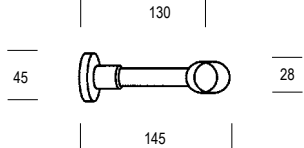
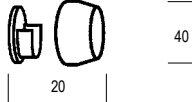
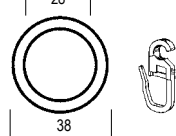
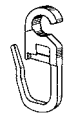
Artikel	Oberfläche	Art.-Nr.	Preis
 <p><b>Stahlrohr 20 mm</b> Länge: 4,80 m</p>	weiß	2010006	13,00
	schwarz	2010013	15,40
	chrom matt	2010025	19,70
	Längen m		
 <p><b>Stahlrohr 20 mm</b></p>	weiß	Z2010006	15,40
	schwarz	Z2010013	18,25
	chrom matt	Z2010025	25,10
	Zuschnitte m		
 <p><b>Endkappe Bera</b> Kunststoff</p>	weiß	2331006	1,60
	schwarz	2331013	1,60
	chrom matt	2331025	3,60
	Stück		
 <p><b>Träger Basic</b> <b>1-Lauf, 14 cm</b> Kunststoff</p>	weiß	2350006	4,60
	schwarz	2350013	4,60
	chrom matt	2350025	6,00
	Stück		
 <p><b>Wandlager</b> Kunststoff</p>	weiß	2345006	4,00
	schwarz	2345013	4,00
	chrom matt	2345025	5,90
	Stück		
 <p><b>Ring mit farbigem Faltenhaken</b> Kunststoff</p>	weiß	1878206	0,27
	schwarz	1878213	0,27
	chrom matt	1878225	1,40
	Stück		
 <p><b>Faltenhaken</b> Kunststoff Öse 6 mm</p>	weiß	1281006	0,15
	schwarz	1281013	0,15
	silberfarbig	1281025	0,15
	Stück		

# INSIDE

# TECDOR





**INSIDE ROMA** – messing glanz – Garnitur-Nr. 1-2813-23



**INSIDE NOVI** – messing glanz – Garnitur-Nr. 1-1631-23



**INSIDE SELVA** – edelstahl – Garnitur-Nr. 1-2036-16



**TECDOR SCALA** – chrom glanz – Garnitur-Nr. 1-20203-22



**INSIDE CAPRI** – chrom glanz – Garnitur-Nr. 2-2810-22



**TECDOR NOTA** – nickel matt – Garnitur-Nr. 1-40152-29

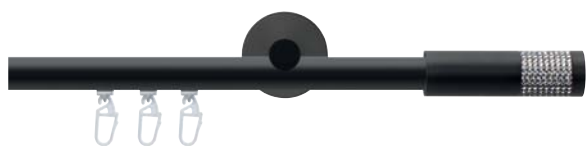

**INSIDE LAGO** – schwarz matt – Garnitur-Nr. 4-2048-157



**TECDOR SABIA** – nickel matt/chrom glanz – Garnitur-Nr. 0-40221-54



**INSIDE RILEVO** – antik weiß – Garnitur-Nr. 1-35004-196



**TECDOR SONA** – nickel matt – Garnitur-Nr. 14-70220-29



**TECDOR NEPI** – chrom glanz – Garnitur-Nr. 12-60160-22



**TECDOR SCHNURZUG** – nicket matt – Garnitur-Nr. 4-2860-29



**TECDOR SONA** – chrom glanz/schwarz – Garnitur-Nr. 1-70220-160

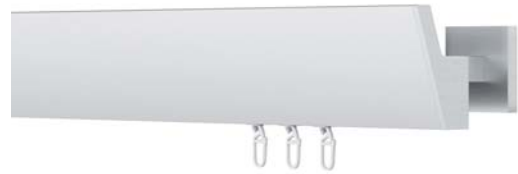

**TECDOR VITA** – aluminium matt – Garnitur-Nr. 0-70420-08



**TECDOR PAVIA** – nicket matt – Garnitur-Nr. 3-30190-29



**TECDOR SALA** – nicket matt – Garnitur-Nr. 1-70570-29



**TECDOR FINA** – weiß – Garnitur-Nr. 1-15150-28



**TECDOR LIRI** – chrom glanz – Garnitur-Nr. 0-70340-22



**TECDOR MARE** – aluminium matt – Garnitur-Nr. 2-40222-08



**TECDOR FINA** – aluminium matt – Garnitur-Nr. 2-20200-08



Entdecken Sie die hochwertigen und stilvollen Garnituren in unserem BÜSCHE Katalog Set mit den Kollektionen INSIDE, TECDOR und VION.

Lassen Sie sich auf den vorhergehenden beiden Seiten von der kleinen Auswahl aus den INSIDE und TECDOR Kollektionen inspirieren und fordern Sie aktuelle Unterlagen bei uns an.

# BÜSCHE VION

16 mm

---

edelstahl

Garnitur-Nr. 4-1706-116



Oberflächen:



-116 edelstahl







Ø 16 mm

# Ø 16 mm Garnituren

VION

WAND- UND DECKENMONTAGE / ROHR 1-/2-LAUF / PROFIL 1-/2-LAUF

---



ALBA - edelstahl - Seite 48 - Garnitur-Nr. 1-1700-116



TERA - edelstahl - Seite 50 - Garnitur-Nr. 1-1701-116



DUNA - edelstahl - Seite 50 - Garnitur-Nr. 1-1704-116



ELANO / ALBA - edelstahl - Seite 50 - Garnitur-Nr. 2-1709-116

## VERFÜGBARE OBERFLÄCHEN



-116 edelstahl



LINE - edelstahl - Seite 46 - Garnitur-Nr. 7-1790-116



LANA - edelstahl - Seite 50 - Garnitur-Nr. 4-1708-116



SINA - edelstahl - Seite 50 - Garnitur-Nr. 4-1706-116



ORIM / LINE - edelstahl - Seite 50 - Garnitur-Nr. 5-1724-116

Ø 16 mm

# Ø 16 mm Garnituren

VION

DECKENMONTAGE / PROFIL 1-LAUF

## BESTELLSCHRITTE

### 1. System









6-1700-116-200

### 2. Garnitur-Nr.

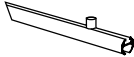
6-1700-116-200

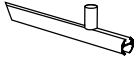
### 3. Farbcode

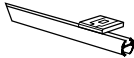
6-1700-116-200

- 6-  1-Lauf Profil  Deckenabstand 16 mm
- 7-  1-Lauf Profil  Deckenabstand 28 mm
- 8-  1-Lauf Profil  Deckenabstand 48 mm
- 10-  1-Lauf Profil  Klick-Deckenträger  
Deckenabstand 18 mm
- 11-  1-Lauf Profil  Deckenabstand 16 mm









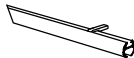

**ALBA**  
1700

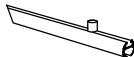
PG A

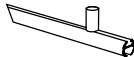

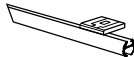
-116  
edelstahl

- 6-  1-Lauf Profil  Deckenabstand 16 mm
- 7-  1-Lauf Profil  Deckenabstand 28 mm
- 8-  1-Lauf Profil  Deckenabstand 48 mm
- 10-  1-Lauf Profil  Klick-Deckenträger  
Deckenabstand 18 mm
- 11-  1-Lauf Profil  Deckenabstand 16 mm



**LINE**  
bündig  
1790

PG A



-116  
edelstahl



Standardgleiter

Gleiter mit Öse

Alle Garnituren inkl. Standardgleiter (Art.-Nr. 739-08) alternativ Gleiter mit Öse (Art.-Nr. 740-08) ohne Aufpreis.

## HINWEISE

Länge cm = Profillänge

Deckenabstand = Oberkante Deckenträger bis Unterkante Profil

\* Gleiterkette, Endhalter und Stechhaken

## DECKENMONTAGE

### 4. Länge

6-1700-116-200

Länge cm	Anzahl Träger	Gleiter pro Lauf	6- 1-Lauf A	7- 1-Lauf A	8- 1-Lauf A	10- 1-Lauf A	11- 1-Lauf A	Aufpreis HB-Klickgleiter	Aufpreis* Set Gleiterkette
100	2	16	79	93	97	79	73	4	49
120	2	18	85	99	103	85	79	4	49
140	2	20	92	106	110	92	86	4	48
160	3	24	109	130	136	109	100	5	48
180	3	26	116	137	143	116	107	6	48
200	3	28	122	143	149	122	113	6	48
220	3	32	129	150	156	129	120	7	59
240	3	34	135	156	162	135	126	7	59
260	3	36	142	163	169	142	133	8	59
280	3	40	148	169	175	148	139	8	58
300	3	42	155	176	182	155	146	9	58
320	4	44	172	200	208	172	160	9	74
340	4	46	179	207	215	179	167	10	74
360	4	48	185	213	221	185	173	10	74
380	4	52	192	220	228	192	180	11	73
400	4	54	198	226	234	198	186	11	73
420	4	56	205	233	241	205	193	12	89
440	4	60	211	239	247	211	199	12	88
460	4	62	218	246	254	218	206	13	88
480	5	64	235	270	280	235	220	13	88
500	5	68	242	277	287	242	227	14	88
520	5	72	249	284	294	249	234	15	99
540	5	74	255	290	300	255	240	15	99
560	5	76	261	296	306	261	246	16	99
580	5	80	268	303	313	268	253	16	98
Abzug / Aufschlag per Wandlager			6	-1	-3	6	9		

Ø 16 mm

Länge cm	Anzahl Träger	Gleiter pro Lauf	6- 1-Lauf A	7- 1-Lauf A	8- 1-Lauf A	10- 1-Lauf A	11- 1-Lauf A	Aufpreis HB-Klickgleiter	Aufpreis* Set Gleiterkette
100	2	16	91	105	109	91	85	4	49
120	2	18	97	111	115	97	91	4	49
140	2	20	104	118	122	104	98	4	48
160	3	24	121	142	148	121	112	5	48
180	3	26	128	149	155	128	119	6	48
200	3	28	134	155	161	134	125	6	48
220	3	32	141	162	168	141	132	7	59
240	3	34	147	168	174	147	138	7	59
260	3	36	154	175	181	154	145	8	59
280	3	40	160	181	187	160	151	8	58
300	3	42	167	188	194	167	158	9	58
320	4	44	184	212	220	184	172	9	74
340	4	46	191	219	227	191	179	10	74
360	4	48	197	225	233	197	185	10	74
380	4	52	204	232	240	204	192	11	73
400	4	54	210	238	246	210	198	11	73
420	4	56	217	245	253	217	205	12	89
440	4	60	223	251	259	223	211	12	88
460	4	62	230	258	266	230	218	13	88
480	5	64	247	282	292	247	232	13	88
500	5	68	254	289	299	254	239	14	88
520	5	72	261	296	306	261	246	15	99
540	5	74	267	302	312	267	252	15	99
560	5	76	273	308	318	273	258	16	99
580	5	80	280	315	325	280	265	16	98
Abzug / Aufschlag per Wandlager			0	-7	-9	0	3		

# Ø 16 mm Garnituren

VION

WANDMONTAGE / ROHR 1-/2-LAUF / PROFIL 1-/2-LAUF

## BESTELLSCHRITTE

### 1. System





1-1700-116-200

### 2. Garnitur-Nr.

6-1700-116-200

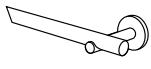
### 3. Farbcode

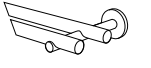
6-1700-116-200

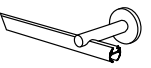
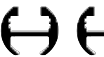
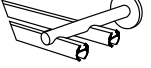
- |    |                                                                                   |                                                                                   |                       |
|----|-----------------------------------------------------------------------------------|-----------------------------------------------------------------------------------|-----------------------|
| 1- |  |  | Wandabstand 65 mm     |
| 2- |  |  | Wandabstand 65/120 mm |
| 4- |  |  | Wandabstand 65 mm     |
| 5- |  |  | Wandabstand 65/120 mm |







**ALBA**  
1700

PG A

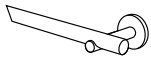

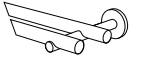
-116  
edelstahl

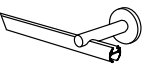
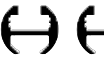
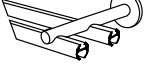
- |    |                                                                                     |                                                                                     |                       |
|----|-------------------------------------------------------------------------------------|-------------------------------------------------------------------------------------|-----------------------|
| 1- |  |  | Wandabstand 65 mm     |
| 2- |  |  | Wandabstand 65/120 mm |
| 4- |  |  | Wandabstand 65 mm     |
| 5- |  |  | Wandabstand 65/120 mm |



**LINE**  
bündig  
1790

PG A



-116  
edelstahl



Standardgleiter

Gleiter mit Öse

Alle Garnituren inkl. Ringe (Art.-Nr. 225720) und FH (Art.-Nr. 718-4-00),  
bzw. Standardgleiter (Art.-Nr. 739-xx) alternativ Gleiter mit Öse (Art.-Nr. 740-xx) ohne Aufpreis.

## HINWEISE

Länge cm = Rohr- bzw. Profillänge

\* pro Lauf

\*\* pro Lauf (Gleiterkette, Endhalter und Stechhaken)

## WANDMONTAGE

### 4. Länge

1-1700-116-200

Länge cm	Anzahl Träger	Ringe Gleiter pro Lauf	1- 1-Lauf A	2- 2-Lauf A	4- 1-Lauf A	5- 2-Lauf A	Aufpreis* HB-Klickgleiter	Aufpreis** Set Gleiterkette
100	2	16	132	226	115	191	4	49
120	2	18	141	243	121	204	4	49
140	2	20	149	259	128	217	4	48
160	3	24	190	322	163	269	5	48
180	3	26	198	338	170	282	6	48
200	3	28	206	354	176	295	6	48
220	3	32	218	378	183	308	7	59
240	3	34	226	394	189	321	7	59
260	3	36	234	411	196	334	8	59
280	3	40	246	434	202	347	8	58
300	3	42	254	451	209	360	9	58
320	4	44	291	506	244	412	9	74
340	4	46	299	522	251	425	10	74
360	4	48	307	538	257	438	10	74
380	4	52	319	562	264	451	11	73
400	4	54	327	578	270	464	11	73
420	4	56	336	595	277	477	12	89
440	4	60	348	619	283	490	12	88
460	4	62	356	635	290	503	13	88
480	5	64	393	690	325	555	13	88
500	5	68	405	714	332	568	14	88
520	5	72	417	738	339	582	15	99
540	5	74	425	754	345	594	15	99
560	5	76	433	770	351	607	16	99
580	5	80	445	794	358	621	16	98

Abzug per Wandlager

-12      -5      -12      -5

Länge cm	Anzahl Träger	Ringe Gleiter pro Lauf	1- 1-Lauf A	2- 2-Lauf A	4- 1-Lauf A	5- 2-Lauf A	Aufpreis* HB-Klickgleiter	Aufpreis** Set Gleiterkette
100	2	16	144	250	127	215	4	49
120	2	18	153	267	133	228	4	49
140	2	20	161	283	140	241	4	48
160	3	24	202	346	175	293	5	48
180	3	26	210	362	182	306	6	48
200	3	28	218	378	188	319	6	48
220	3	32	230	402	195	332	7	59
240	3	34	238	418	201	345	7	59
260	3	36	246	435	208	358	8	59
280	3	40	258	458	214	371	8	58
300	3	42	266	475	221	384	9	58
320	4	44	303	530	256	436	9	74
340	4	46	311	546	263	449	10	74
360	4	48	319	562	269	462	10	74
380	4	52	331	586	276	475	11	73
400	4	54	339	602	282	488	11	73
420	4	56	348	619	289	501	12	89
440	4	60	360	643	295	514	12	88
460	4	62	368	659	302	527	13	88
480	5	64	405	714	337	579	13	88
500	5	68	417	738	344	592	14	88
520	5	72	429	762	351	606	15	99
540	5	74	437	778	357	618	15	99
560	5	76	445	794	363	631	16	99
580	5	80	457	818	370	645	16	98

Abzug per Wandlager

-18      -17      -18      -17

Wellenband und Gleiterkette sowie Zubehör ab Seite 24

Bestellangaben: System, Garnitur-Nr., Farbcode, Länge · Unverbindlich empfohlene Verkaufspreise in € inkl. MwSt. | Stand 11.2022



Ø 16 mm

# Ø 16 mm Garnituren

VION

WANDMONTAGE / ROHR 1-/2-LAUF / PROFIL 1-/2-LAUF

## BESTELLSCHRITTE

### 1. System









2-1701-116-200

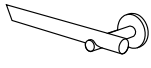



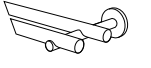

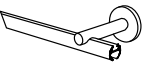
### 2. Garnitur-Nr.

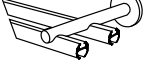
2-1701-116-200

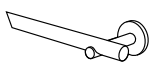
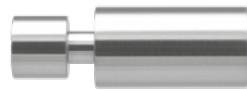
### 3. Farbcode

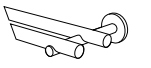
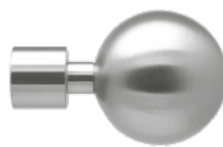
2-1701-116-200

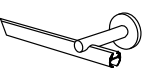
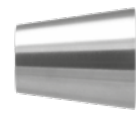
1-				<b>TERA</b> 1701	PG A  -116 edelstahl
2-				<b>DUNA</b> 1704	
4-				<b>SINA</b> 1706	
5-					

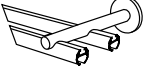
1-				<b>LANA</b> 1708	PG A  -116 edelstahl
2-				<b>ELANO</b> 1709	
4-				<b>ORIM</b> bündig 1724	
5-					



Alle Garnituren inkl. Ringe (Art.-Nr. 225720) und FH (Art.-Nr. 718-4-00),  
bzw. Standardgleiter (Art.-Nr. 739-xx) alternativ Gleiter mit Öse (Art.-Nr. 740-xx) ohne Aufpreis.



## HINWEISE

Länge cm = Rohr- bzw. Profillänge

\* pro Lauf

\*\* pro Lauf (Gleiterkette, Endhalter und Stechhaken)

## WANDMONTAGE

### 4. Länge

2-1701-116-200

Länge cm	Anzahl Träger	Ringe Gleiter pro Lauf	1- 1-Lauf A	2- 2-Lauf A	4- 1-Lauf A	5- 2-Lauf A	Aufpreis* HB-Klickgleiter	Aufpreis** Set Gleiterkette
100	2	16	148	242	131	207	4	49
120	2	18	157	259	137	220	4	49
140	2	20	165	275	144	233	4	48
160	3	24	206	338	179	285	5	48
180	3	26	214	354	186	298	6	48
200	3	28	222	370	192	311	6	48
220	3	32	234	394	199	324	7	59
240	3	34	242	410	205	337	7	59
260	3	36	250	427	212	350	8	59
280	3	40	262	450	218	363	8	58
300	3	42	270	467	225	376	9	58
320	4	44	307	522	260	428	9	74
340	4	46	315	538	267	441	10	74
360	4	48	323	554	273	454	10	74
380	4	52	335	578	280	467	11	73
400	4	54	343	594	286	480	11	73
420	4	56	352	611	293	493	12	89
440	4	60	364	635	299	506	12	88
460	4	62	372	651	306	519	13	88
480	5	64	409	706	341	571	13	88
500	5	68	421	730	348	584	14	88
520	5	72	433	754	355	598	15	99
540	5	74	441	770	361	610	15	99
560	5	76	449	786	367	623	16	99
580	5	80	461	810	374	637	16	98

Abzug per Wandlager

-20      -13      -20      -13

Länge cm	Anzahl Träger	Ringe Gleiter pro Lauf	1- 1-Lauf A	2- 2-Lauf A	4- 1-Lauf A	5- 2-Lauf A	Aufpreis* HB-Klickgleiter	Aufpreis** Set Gleiterkette
100	2	16	174	268	157	233	4	49
120	2	18	183	285	163	246	4	49
140	2	20	191	301	170	259	4	48
160	3	24	232	364	205	311	5	48
180	3	26	240	380	212	324	6	48
200	3	28	248	396	218	337	6	48
220	3	32	260	420	225	350	7	59
240	3	34	268	436	231	363	7	59
260	3	36	276	453	238	376	8	59
280	3	40	288	476	244	389	8	58
300	3	42	296	493	251	402	9	58
320	4	44	333	548	286	454	9	74
340	4	46	341	564	293	467	10	74
360	4	48	349	580	299	480	10	74
380	4	52	361	604	306	493	11	73
400	4	54	369	620	312	506	11	73
420	4	56	378	637	319	519	12	89
440	4	60	390	661	325	532	12	88
460	4	62	398	677	332	545	13	88
480	5	64	435	732	367	597	13	88
500	5	68	447	756	374	610	14	88
520	5	72	459	780	381	624	15	99
540	5	74	467	796	387	636	15	99
560	5	76	475	812	393	649	16	99
580	5	80	487	836	400	663	16	98

Abzug per Wandlager

-33      -26      -33      -26

Wellenband und Gleiterkette sowie Zubehör ab Seite 24

Bestellangaben: System, Garnitur-Nr., Farbcode, Länge · Unverbindlich empfohlene Verkaufspreise in € inkl. MwSt. | Stand 11.2022



# Ø 16 mm Einzelteile

VION

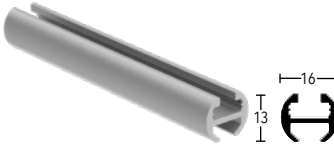
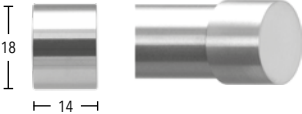
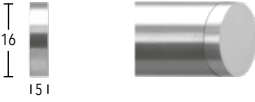
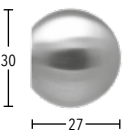
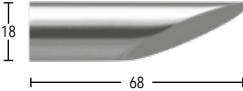
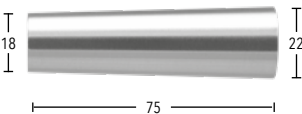
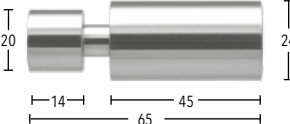
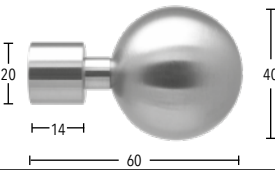
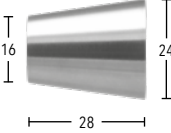
	ARTIKEL	OBERFLÄCHE	ART.-NR.	€/STCK.	
	<b>EDELSTAHL-ROHR</b> Ø 16 mm Preis € per Meter Lagerlänge 6 m	edelstahl	800-16-116	Zuschnitt €/m 21,60	Lagerlänge €/m 18,00
	<b>ALUMINIUM-PROFIL</b> Ø 16 mm Preis € per Meter Lagerlänge 6 m	edelstahl	808-16-116	Zuschnitt €/m 31,20	Lagerlänge €/m 26,00
	<b>ENDKAPPE ALBA</b> für Ø 16 mm VE = 10 Stück	edelstahl	163000-116	11,00	
	<b>ENDKAPPE LINE</b> für Ø 16 mm bündig VE = 10 Stück	edelstahl	163100-116	17,00	
	<b>ENDSTÜCK TERA</b> für Ø 16 mm VE = 10 Stück	edelstahl	163010-116	19,00	
	<b>ENDSTÜCK DUNA</b> für Ø 16 mm VE = 10 Stück	edelstahl	163013-116	19,00	
	<b>ENDSTÜCK SINA</b> für Ø 16 mm VE = 10 Stück	edelstahl	163015-116	19,00	
	<b>ENDSTÜCK LANA</b> für Ø 16 mm VE = 10 Stück	edelstahl	163020-116	32,00	
	<b>ENDSTÜCK ELANO</b> für Ø 16 mm VE = 10 Stück	edelstahl	163021-116	32,00	
	<b>ENDSTÜCK ORIM</b> für Ø 16 mm bündig VE = 10 Stück	edelstahl	163031-116	26,00	

Unverbindlich empfohlene Verkaufspreise in € inkl. MwSt. | Stand 11.2022

# Ø 16 mm Einzelteile

	ARTIKEL	OBERFLÄCHE	ART.-NR.	€ / STCK.
	<b>WANDTRÄGER ALUX (System 1- + 4-)</b> 1-läufig, Wandabstand 65 mm ohne Abdeckung (Art.-Nr. 165001) für Ø 16 mm Rohre / Profile  VE = 10 Stück	edelstahl	164065-116	29,00
	<b>WANDTRÄGER ALUX</b> 1-läufig, Wandabstand 120 mm ohne Abdeckung (Art.-Nr. 165001) für Ø 16 mm Rohre / Profile  VE = 10 Stück	edelstahl	164120-116	35,00
	<b>WANDTRÄGER ALUX (System 2- + 5-)</b> 2-läufig, Wandabstand 65/120 mm ohne Abdeckung (Art.-Nr. 165001) für Ø 16 mm Rohre / Profile  VE = 10 Stück	edelstahl	165120-116	39,00
	<b>MULTI-WANDTRÄGER ALUX</b> zur Befestigung von 1-5 Profilen Wandabstand 40-135 mm für Ø 16 mm Profile  VE = 10 Stück	edelstahl	205320-116	50,00
	<b>ABDECKUNG FÜR ALLE TRÄGER ALUX</b> zur Abdeckung der Bohrungen bei Verwendung als Rohrträger  VE = 10 Stück	edelstahl	165001-116	5,00
	<b>TRÄGERVERLÄNGERUNG</b> Länge 35 mm für alle Träger ALUX  VE = 10 Stück	edelstahl	166035-116	13,00
	<b>TRÄGERAUFNAHME</b> für gekürzte Träger ALUX  VE = 10 Stück	edelstahl	167002-116	14,00
	<b>DECKENTRÄGER 3 mm (System 6-)</b> 1-läufig, Deckenabstand 16 mm für Profile  VE = 10 Stück	silber weiß	11592-00 -28	11,00 11,00
	<b>DECKENTRÄGER 3 mm (System 11-)</b> inklusive Bohrlochabdeckung 1-läufig, Deckenabstand 16 mm für Profile  VE = 10 Stück	silber weiß	11597-00 -28	8,00 8,00
	<b>KLICK-DECKENTRÄGER 5 mm (System 10-)</b> 1-läufig, Deckenabstand 18 mm Material: Kunststoff für Profile  VE = 10 Stück	weiß	11693-00	11,00

Ø 16 mm



# Ø 16 mm Einzelteile

VION

	ARTIKEL	OBERFLÄCHE	ART.-NR.	€ / STCK.
	<b>DECKENTRÄGER 15 mm (System 7-)</b> 1-läufig, Deckenabstand 28 mm für Profile  VE = 10 Stück	edelstahl	164915-116	18,00
	<b>DECKENTRÄGER 35 mm (System 8-)</b> 1-läufig, Deckenabstand 48 mm für Profile  VE = 10 Stück	edelstahl	164935-116	20,00
	<b>DECKENTRÄGER 42 mm</b> 1-läufig, Deckenabstand 55 mm mit 3-Loch Montageplatte für Profile  VE = 10 Stück	edelstahl	164942-116	29,00
	<b>DECKENTRÄGER 500 mm</b> 1-läufig, Deckenabstand 55-513 mm (kürzbar) mit 3-Loch Montageplatte für Profile  VE = 1 Stück	edelstahl	164995-116	48,00
	<b>WANDLAGER</b> für Ø 16 mm  VE = 10 Stück	edelstahl	167001-116	28,00
	<b>PROFILVERBINDER</b> für Profile  VE = 10 Stück	silber	899-3-00	10,00
	<b>PROFILVERBINDER</b> verstellbar für Profile VE = 10 Stück »Gehrungsschnitt siehe Info-Seite 28«	silber	899-3.1-01	24,00
	<b>ROHRVERBINDER</b> für Ø 16 mm Rohre  VE = 10 Stück	weiß	83016-000	11,00
	<b>GELENKVERBINDER</b> für Ø 16 mm Rohre und Profile  VE = 10 Stück	edelstahl	122916-116	50,00
	<b>FLACHRING</b> Innen-Ø 28 mm, Außen-Ø 32 mm  VE = 100 Stück	edelstahl	225720-116	1,80
	<b>FALTENLEGHAKEN</b> <b>ÖSENHAKEN</b> für Flachringe Art.-Nr. 225720-116  VE = 100 Stück	transparent transparent	718-4-00 722-4-00	0,10 0,10

Unverbindlich empfohlene Verkaufspreise in € inkl. MwSt. | Stand 11.2022

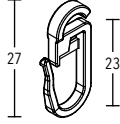
# Ø 16 mm Einzelteile

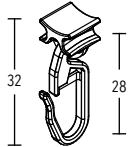
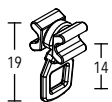
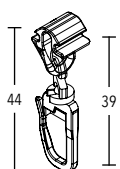
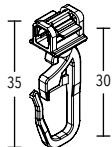
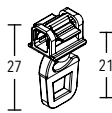
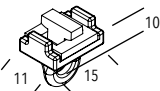
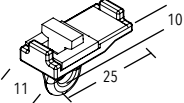
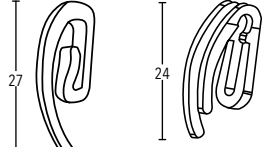
	ARTIKEL	OBERFLÄCHE	ART.-NR.	€ / STCK.
	<b>FLACHRING MIT KUNSTSTOFFEINLAGE</b> Innen-Ø 27 mm / Außen-Ø 34 mm  VE = 50 Stück	nickel matt	125820-29	3,20
	<b>FALTENLEGHAKEN</b> für Flachringe mit Kunststoffeinlage Art.-Nr. 125820-29  VE = 100 Stück	transparent silber	844-00 -29	0,10 0,10
	<b>FLACHRING MIT ÖSE</b> und Kunststoffeinlage Innen-Ø 27 mm / Außen-Ø 34 mm  VE = 50 Stück	nickel matt	125920-29	4,20
	<b>GLEITER MIT FALTENLEGHAKEN</b> für Profile  VE = 100 Stück	weiß grau	739-00 -08	0,10 0,10
	<b>GLEITER MIT ÖSE</b> für Profile  VE = 100 Stück	weiß grau	740-00 -08	0,10 0,10
	<b>HB-KLICK-GLEITER MIT FALTENLEGHAKEN drehbar</b> <b>HB-KLICK-GLEITER MIT ÖSE</b> Klick-In / Klick-Out, herausnehmbar für Profile  VE = 100 Stück	weiß weiß	769-00 770-00	0,30 0,30
	<b>KLICK-GLEITER MIT FALTENLEGHAKEN</b> für Profile  VE = 100 Stück	weiß grau	742-00 -08	0,30 0,30
	<b>KLICK-GLEITER MIT ÖSE</b> für Profile  VE = 100 Stück	weiß grau	743-00 -08	0,30 0,30
	<b>FESTSTELLER "ANTI RUTSCH"</b> für Profile  VE = 100 Stück	weiß grau	799-20-00 -08	0,80 0,80
	<b>FESTSTELLER "ANTI RUTSCH"</b> zur Abdeckung einer Ausklindung für Profile VE = 100 Stück	weiß grau	799-40-00 -08	0,80 0,80
	<b>STECHHAKEN</b> <b>DOPPEL-STECHHAKEN</b>  VE = 100 Stück	weiß weiß	869-00 853-00	0,10 0,20

Ø 16 mm

# BÜSCHE VION

Ø 20 mm

---

silber / buche

Garnitur-Nr. 4-2120-108/221

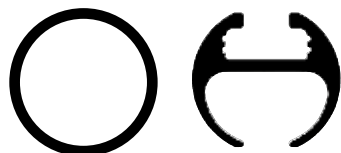

## Oberflächen:



-28 weiß



-108 silber



-109 gold



-116 edelstahl



-132 bronze



-157 schwarz matt



-221 buche



-222 wildeiche



-223 zwetschge

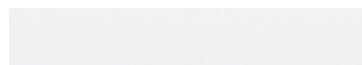

-328 struktur weiß



-357 struktur schwarz





Ø 20 mm

# Ø 20 mm Garnituren

VION

WAND- UND DECKENMONTAGE / ROHR 1-/2-LAUF / KOMBI 2-LAUF / PROFIL 1-/2-LAUF

---



ALBA - schwarz matt - Seite 68 - Garnitur-Nr. 1-2100-157



FULA - bronze - Seite 70 - Garnitur-Nr. 1-2103-132



FALA - edelstahl / wildeiche - Seite 72 - Garnitur-Nr. 4-2120-116/222



TELO / ALBA - silber - Seite 70 - Garnitur-Nr. 3-2104-108



## VERFÜGBARE OBERFLÄCHEN



LINE - edelstahl - Seite 66 - Garnitur-Nr. 7-2190-116



SOLA - silber - Seite 70 - Garnitur-Nr. 1-2122-108

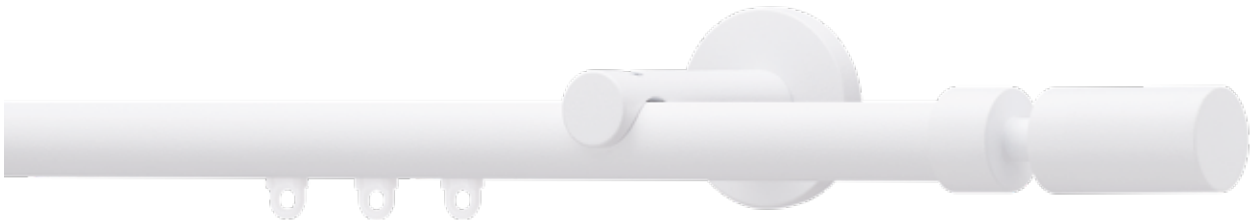

LANA - struktur weiß - Seite 70 - Garnitur-Nr. 4-2105-328



ELANO / ALBA - struktur schwarz - Seite 70 - Garnitur-Nr. 5-2106-357

Ø 20 mm

# Ø 20 mm Garnituren

VION

WAND- UND DECKENMONTAGE / ROHR 1-/2-LAUF / KOMBI 2-LAUF / PROFIL 1-/2-LAUF

---



ORIM - gold - Seite 70 - Garnitur-Nr. 1-2124-109

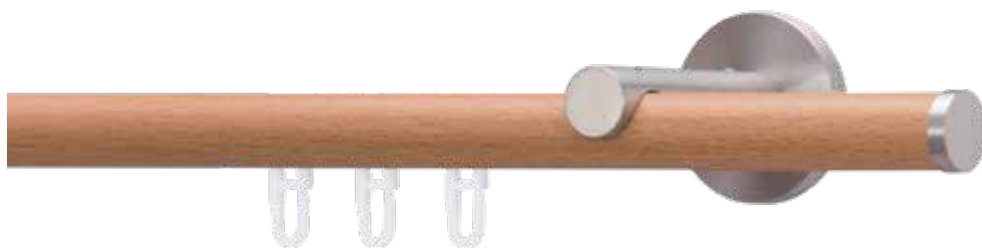

LINE - edelstahl / buche - Seite 72 - Garnitur-Nr. 4-2190-116/221

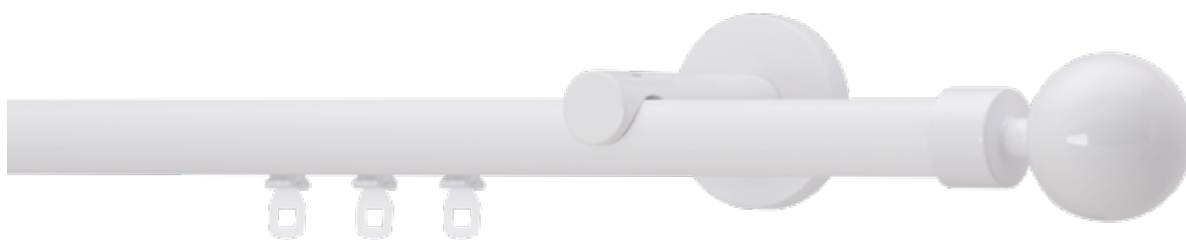

ELANO - weiß - Seite 70 - Garnitur-Nr. 4-2106-28



MELO / ALBA - silber - Seite 70 - Garnitur-Nr. 2-2102-108

## VERFÜGBARE OBERFLÄCHEN



LINE - struktur schwarz - Seite 68 - Garnitur-Nr. 4-2190-357



MELO - struktur weiß - Seite 70 - Garnitur-Nr. 4-2102-328



ORIM - edelstahl / zwetschge - Seite 72 - Garnitur-Nr. 4-2124-108/223



TELO / ALBA - edelstahl - Seite 70 - Garnitur-Nr. 5-2104-116

Ø 20 mm

# Ø 20 mm Garnituren

VION

DECKENMONTAGE / PROFIL 1-LAUF

## BESTELLSCHRITTE

### 1. System







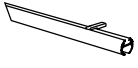

6-2100-116-200

### 2. Garnitur-Nr.

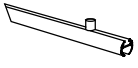
6-2100-116-200

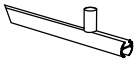
### 3. Farbcode

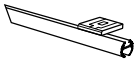

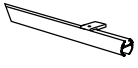



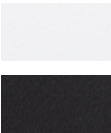

6-2100-116-200

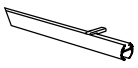
- 6-  1-Lauf Profil Deckenabstand 21 mm 
- 7-  1-Lauf Profil Deckenabstand 33 mm 
- 8-  1-Lauf Profil Deckenabstand 53 mm 
- 10-  1-Lauf Profil Klick-Deckenträger Deckenabstand 23 mm 
- 11-  1-Lauf Profil Deckenabstand 21 mm 

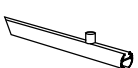

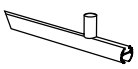
**ALBA**  
2100

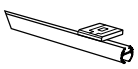
- PG A 
  - 116 edelstahl
  - 28 weiß
  - 108 silber
  - 157 schwarz matt
- PG B 
  - 109 gold
  - 132 bronze
- PG C 
  - 328 struktur weiß
  - 357 struktur schwarz

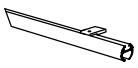
- 6-  1-Lauf Profil Deckenabstand 21 mm 
- 7-  1-Lauf Profil Deckenabstand 33 mm 
- 8-  1-Lauf Profil Deckenabstand 53 mm 
- 10-  1-Lauf Profil Klick-Deckenträger Deckenabstand 23 mm 
- 11-  1-Lauf Profil Deckenabstand 21 mm 



**LINE**  
bündig  
2190

- PG A 
  - 116 edelstahl
  - 28 weiß
  - 108 silber
  - 157 schwarz matt
- PG B 
  - 109 gold
  - 132 bronze
- PG C 
  - 328 struktur weiß
  - 357 struktur schwarz



Alle Garnituren inkl. Standardgleiter (Art.-Nr. 739-xx) alternativ Gleiter mit Öse (Art.-Nr. 740-xx) ohne Aufpreis.  
Oberflächen -328 + -357 inkl. Rollengleiter (Art.-Nr. 752-00) alternativ Rollengleiter mit Öse (Art.-Nr. 751-00) ohne Aufpreis.

**HINWEISE**

Länge cm = Profillänge

Deckenabstand = Oberkante Deckenträger bis Unterkante Profil

\* Gleiterkette, Endhalter und Stechhaken

**DECKENMONTAGE**

**4. Länge**

6-2100-116-200

Länge cm	Anzahl Träger	Gleiter pro Lauf	6- 1-Lauf			7- 1-Lauf			8- 1-Lauf			10- 1-Lauf			11- 1-Lauf			Aufpreis HB-Klickgleiter	Aufpreis* Set Gleiterkette
			A	B	C	A	B	C	A	B	C	A	B	C	A	B	C		
100	2	16	86	87	94	100	105	108	104	109	112	86	87	94	80	81	88	4	49
120	2	18	93	94	103	107	112	117	111	116	121	93	94	103	87	88	97	4	49
140	2	20	100	101	111	114	119	125	118	123	129	100	101	111	94	95	105	4	48
160	2	24	108	108	121	122	126	135	126	130	139	108	108	121	102	102	115	5	48
180	3	26	126	126	140	147	153	161	153	159	167	126	126	140	117	117	131	6	48
200	3	28	134	133	149	155	160	170	161	166	176	134	133	149	125	124	140	6	48
220	3	32	141	140	159	162	167	180	168	173	186	141	140	159	132	131	150	7	59
240	3	34	149	147	167	170	174	188	176	180	194	149	147	167	140	138	158	7	59
260	3	36	156	154	175	177	181	196	183	187	202	156	154	175	147	145	166	8	59
280	3	40	164	161	185	185	188	206	191	194	212	164	161	185	155	152	176	8	58
300	3	42	171	168	193	192	195	214	198	201	220	171	168	193	162	159	184	9	58
320	3	44	179	175	202	200	202	223	206	208	229	179	175	202	170	166	193	9	74
340	3	46	186	182	210	207	209	231	213	215	237	186	182	210	177	173	201	10	74
360	4	48	204	200	229	232	236	257	240	244	265	204	200	229	192	188	217	10	74
380	4	52	212	207	239	240	243	267	248	251	275	212	207	239	200	195	227	11	73
400	4	54	219	214	248	247	250	276	255	258	284	219	214	248	207	202	236	11	73
420	4	56	227	221	256	255	257	284	263	265	292	227	221	256	215	209	244	12	89
440	4	60	234	228	266	262	264	294	270	272	302	234	228	266	222	216	254	12	88
460	4	62	242	235	274	270	271	302	278	279	310	242	235	274	230	223	262	13	88
480	4	64	249	242	283	277	278	311	285	286	319	249	242	283	237	230	271	13	88
500	4	68	257	249	292	285	285	320	293	293	328	257	249	292	245	237	280	14	88
520	4	72	264	256	302	292	292	330	300	300	338	264	256	302	252	244	290	15	99
540	5	74	283	274	322	318	319	357	328	329	367	283	274	322	268	259	307	15	99
560	5	76	290	281	330	325	326	365	335	336	375	290	281	330	275	266	315	16	99
580	5	80	298	288	340	333	333	375	343	343	385	298	288	340	283	273	325	16	98

Abzug / Aufschlag per Wandlager 5 5 5 -2 -4 -2 -4 -6 -4 5 5 5 8 8 8

Länge cm	Anzahl Träger	Gleiter pro Lauf	6- 1-Lauf			7- 1-Lauf			8- 1-Lauf			10- 1-Lauf			11- 1-Lauf			Aufpreis HB-Klickgleiter	Aufpreis* Set Gleiterkette
			A	B	C	A	B	C	A	B	C	A	B	C	A	B	C		
100	2	16	100	101	108	114	119	122	118	123	126	100	101	108	94	95	102	4	49
120	2	18	107	108	117	121	126	131	125	130	135	107	108	117	101	102	111	4	49
140	2	20	114	115	125	128	133	139	132	137	143	114	115	125	108	109	119	4	48
160	2	24	122	122	135	136	140	149	140	144	153	122	122	135	116	116	129	5	48
180	3	26	140	140	154	161	167	175	167	173	181	140	140	154	131	131	145	6	48
200	3	28	148	147	163	169	174	184	175	180	190	148	147	163	139	138	154	6	48
220	3	32	155	154	173	176	181	194	182	187	200	155	154	173	146	145	164	7	59
240	3	34	163	161	181	184	188	202	190	194	208	163	161	181	154	152	172	7	59
260	3	36	170	168	189	191	195	210	197	201	216	170	168	189	161	159	180	8	59
280	3	40	178	175	199	199	202	220	205	208	226	178	175	199	169	166	190	8	58
300	3	42	185	182	207	206	209	228	212	215	234	185	182	207	176	173	198	9	58
320	3	44	193	189	216	214	216	237	220	222	243	193	189	216	184	180	207	9	74
340	3	46	200	196	224	221	223	245	227	229	251	200	196	224	191	187	215	10	74
360	4	48	218	214	243	246	250	271	254	258	279	218	214	243	206	202	231	10	74
380	4	52	226	221	253	254	257	281	262	265	289	226	221	253	214	209	241	11	73
400	4	54	233	228	262	261	264	290	269	272	298	233	228	262	221	216	250	11	73
420	4	56	241	235	270	269	271	298	277	279	306	241	235	270	229	223	258	12	89
440	4	60	248	242	280	276	278	308	284	286	316	248	242	280	236	230	268	12	88
460	4	62	256	249	288	284	285	316	292	293	324	256	249	288	244	237	276	13	88
480	4	64	263	256	297	291	292	325	299	300	333	263	256	297	251	244	285	13	88
500	4	68	271	263	306	299	299	334	307	307	342	271	263	306	259	251	294	14	88
520	4	72	278	270	316	306	306	344	314	314	352	278	270	316	266	258	304	15	99
540	5	74	297	288	336	332	333	371	342	343	381	297	288	336	282	273	321	15	99
560	5	76	304	295	344	339	340	379	349	350	389	304	295	344	289	280	329	16	99
580	5	80	312	302	354	347	347	389	357	357	399	312	302	354	297	287	339	16	98

Abzug / Aufschlag per Wandlager -2 -2 -2 -9 -11 -9 -11 -13 -11 -2 -2 -2 1 1 1

Wellenband und Gleiterkette sowie Zubehör ab Seite 24

Bestellangaben: System, Garnitur-Nr., Farbcode, Länge · Unverbindlich empfohlene Verkaufspreise in € inkl. MwSt. | Stand 11.2022



# Ø 20 mm Garnituren

VION

WANDMONTAGE / ROHR 1-/2-LAUF / KOMBI 2-LAUF / PROFIL 1-/2-LAUF

## BESTELLSCHRITTE

### 1. System

1-2100-116-200

### 2. Garnitur-Nr.

1-2100-116-200

### 3. Farbcode

1-2100-116-200

- 1-    
1-Lauf Rohr Wandabstand 65 mm
- 2-    
2-Lauf Rohr Wandabstand 65/120 mm
- 3-    
2-Lauf Kombi Wandabstand 65/120 mm
- 4-    
1-Lauf Profil Wandabstand 65 mm
- 5-    
2-Lauf Profil Wandabstand 65/120 mm



**ALBA**  
2100

- PG A  -116 edelstahl
-  -28 weiß
-  -108 silber
-  -157 schwarz matt
- PG B  -109 gold
-  -132 bronze
- PG C  -328\* struktur weiß
-  -357\* struktur schwarz

\* nur System 4 + 5

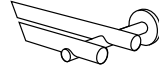
- 1-    
1-Lauf Rohr Wandabstand 65 mm
- 2-    
2-Lauf Rohr Wandabstand 65/120 mm
- 3-    
2-Lauf Kombi Wandabstand 65/120 mm
- 4-    
1-Lauf Profil Wandabstand 65 mm
- 5-    
2-Lauf Profil Wandabstand 65/120 mm



**LINE**  
bündig  
2190

- PG A  -116 edelstahl
-  -28 weiß
-  -108 silber
-  -157 schwarz matt
- PG B  -109 gold
-  -132 bronze
- PG C  -328\* struktur weiß
-  -357\* struktur schwarz

\* nur System 4 + 5



Alle Garnituren inkl. Ringe (Art.-Nr. 225720 / 202040) und FH (Art.-Nr. 718-4 / 818-6), bzw. Standardgleiter (Art.-Nr. 739-xx) alternativ Gleiter mit Öse (Art.-Nr. 740-xx) ohne Aufpreis. Oberflächen -328 + -357 inkl. Rollengleiter (Art.-Nr. 752-00) alternativ Rollengleiter mit Öse (Art.-Nr. 751-00) ohne Aufpreis.

## HINWEISE

Länge cm = Rohr- bzw. Profillänge

\* pro Lauf

\*\* pro Lauf (Gleiterkette, Endhalter und Stechhaken)

## WANDMONTAGE

### 4. Länge

1-2100-116-200

Länge cm	Anzahl Träger	Ringe Gleiter pro Lauf	1-Lauf		2-Lauf		2-Lauf		4-Lauf			5-Lauf			Aufpreis* HB-Klickgleiter	Aufpreis** Set Gleiterkette
			A	B	A	B	A	B	A	B	C	A	B	C		
100	2	16	137	152	235	258	220	237	122	131	130	205	216	222	4	49
120	2	18	145	161	252	276	236	253	129	138	139	220	230	239	4	49
140	2	20	154	170	270	294	252	269	136	145	147	234	244	256	4	48
160	2	24	166	183	294	320	272	289	144	152	157	250	258	276	5	48
180	3	26	204	225	351	381	327	348	180	192	194	303	315	331	6	48
200	3	28	213	234	368	399	343	364	188	199	203	318	329	348	6	48
220	3	32	225	247	393	425	363	384	195	206	213	333	343	368	7	59
240	3	34	234	256	410	443	379	400	203	213	221	348	357	384	7	59
260	3	36	242	265	427	461	395	416	210	220	229	363	371	401	8	59
280	3	40	255	279	452	488	415	436	218	227	239	378	385	421	8	58
300	3	42	263	288	469	506	431	452	225	234	247	393	399	437	9	58
320	3	44	272	297	486	524	447	468	233	241	256	408	413	454	9	74
340	3	46	280	306	503	542	463	484	240	248	264	423	426	471	10	74
360	4	48	318	348	560	603	518	543	276	288	301	476	483	526	10	74
380	4	52	330	361	584	629	538	563	284	295	311	492	497	546	11	73
400	4	54	339	370	602	647	554	579	291	302	320	506	511	563	11	73
420	4	56	348	379	619	665	570	595	299	309	328	521	525	580	12	89
440	4	60	360	392	644	692	590	616	306	316	338	536	539	599	12	88
460	4	62	369	401	661	710	606	631	314	323	346	551	553	616	13	88
480	4	64	377	410	678	728	622	647	321	330	355	566	567	633	13	88
500	4	68	390	423	703	754	642	668	329	337	364	581	581	652	14	88
520	4	72	402	436	728	780	662	688	336	344	374	596	596	672	15	99
540	5	74	440	478	784	841	717	747	373	384	412	650	652	728	15	99
560	5	76	448	487	801	859	733	763	380	391	420	665	666	745	16	99
580	5	80	461	501	826	886	753	783	388	398	430	680	680	764	16	98
Abzug per Wandlager			-13	-17	-7	-11	-7	-11	-13	-17	-13	-7	-11	-7		

Ø 20 mm

Länge cm	Anzahl Träger	Ringe Gleiter pro Lauf	1-Lauf		2-Lauf		2-Lauf		4-Lauf			5-Lauf			Aufpreis* HB-Klickgleiter	Aufpreis** Set Gleiterkette
			A	B	A	B	A	B	A	B	C	A	B	C		
100	2	16	151	166	263	286	248	265	136	145	144	233	244	250	4	49
120	2	18	159	175	280	304	264	281	143	152	153	248	258	267	4	49
140	2	20	168	184	298	322	280	297	150	159	161	262	272	284	4	48
160	2	24	180	197	322	348	300	317	158	166	171	278	286	304	5	48
180	3	26	218	239	379	409	355	376	194	206	208	331	343	359	6	48
200	3	28	227	248	396	427	371	392	202	213	217	346	357	376	6	48
220	3	32	239	261	421	453	391	412	209	220	227	361	371	396	7	59
240	3	34	248	270	438	471	407	428	217	227	235	376	385	412	7	59
260	3	36	256	279	455	489	423	444	224	234	243	391	399	429	8	59
280	3	40	269	293	480	516	443	464	232	241	253	406	413	449	8	58
300	3	42	277	302	497	534	459	480	239	248	261	421	427	465	9	58
320	3	44	286	311	514	552	475	496	247	255	270	436	441	482	9	74
340	3	46	294	320	531	570	491	512	254	262	278	451	454	499	10	74
360	4	48	332	362	588	631	546	571	290	302	315	504	511	554	10	74
380	4	52	344	375	612	657	566	591	298	309	325	520	525	574	11	73
400	4	54	353	384	630	675	582	607	305	316	334	534	539	591	11	73
420	4	56	362	393	647	693	598	623	313	323	342	549	553	608	12	89
440	4	60	374	406	672	720	618	644	320	330	352	564	567	627	12	88
460	4	62	383	415	689	738	634	659	328	337	360	579	581	644	13	88
480	4	64	391	424	706	756	650	675	335	344	369	594	595	661	13	88
500	4	68	404	437	731	782	670	696	343	351	378	609	609	680	14	88
520	4	72	416	450	756	808	690	716	350	358	388	624	624	700	15	99
540	5	74	454	492	812	869	745	775	387	398	426	678	680	756	15	99
560	5	76	462	501	829	887	761	791	394	405	434	693	694	773	16	99
580	5	80	475	515	854	914	781	811	402	412	444	708	708	792	16	98
Abzug per Wandlager			-20	-24	-21	-25	-21	-25	-20	-24	-20	-21	-25	-21		

# Ø 20 mm Garnituren

VION

WANDMONTAGE / ROHR 1-/2-LAUF / KOMBI 2-LAUF / PROFIL 1-/2-LAUF

## BESTELLSCHRITTE

### 1. System







1-2102-116-200

### 2. Garnitur-Nr.

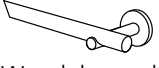
1-2102-116-200

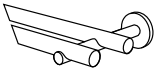
### 3. Farbcode

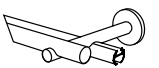
1-2102-116-200

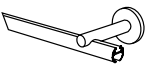
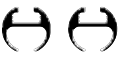
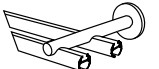
- 1-   1-Lauf Rohr Wandabstand 65 mm
- 2-   2-Lauf Rohr Wandabstand 65/120 mm
- 3-   2-Lauf Kombi Wandabstand 65/120 mm
- 4-   1-Lauf Profil Wandabstand 65 mm
- 5-   2-Lauf Profil Wandabstand 65/120 mm

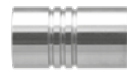

**MELO**  
2102



**FALA**  
bündig  
2120\*



**SOLA**  
bündig  
2122\*\*

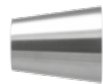

**ORIM**  
bündig  
2124

\* nicht in -109 und -132 verfügbar

\*\* nicht in -109, -132, -328 und -357 verfügbar

PG A



-116  
edelstahl



-28  
weiß



-108  
silber



-157  
schwarz matt

PG B



-109  
gold



-132  
bronze

PG C

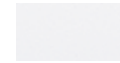







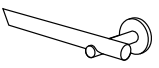

-328\*  
struktur weiß

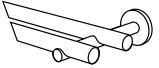

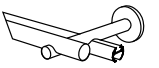
-357\*  
struktur schwarz

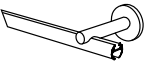
\* nur System 4 + 5

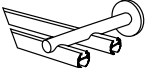
- 1-   1-Lauf Rohr Wandabstand 65 mm
- 2-   2-Lauf Rohr Wandabstand 65/120 mm
- 3-   2-Lauf Kombi Wandabstand 65/120 mm
- 4-   1-Lauf Profil Wandabstand 65 mm
- 5-   2-Lauf Profil Wandabstand 65/120 mm



**FULA**  
2103\*\*



**TELO**  
2104\*\*



**LANA**  
2105\*

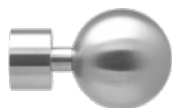

**ELANO**  
2106

\* nicht in -109 und -132 verfügbar

\*\* nicht in -28, -328 und -357 verfügbar

PG A



-116  
edelstahl



-28  
weiß



-108  
silber



-157  
schwarz matt

PG B



-109  
gold



-132  
bronze

PG C

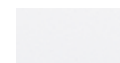

-328\*  
struktur weiß



-357\*  
struktur schwarz

\* nur System 4 + 5



Alle Garnituren inkl. Ringe (Art.-Nr. 225720 / 202040) und FH (Art.-Nr. 718-4 / 818-6), bzw. Standardgleiter (Art.-Nr. 739-xx) alternativ Gleiter mit Öse (Art.-Nr. 740-xx) ohne Aufpreis. Oberflächen -328 + -357 inkl. Rollengleiter (Art.-Nr. 752-00) alternativ Rollengleiter mit Öse (Art.-Nr. 751-00) ohne Aufpreis.



## HINWEISE

Länge cm = Rohr- bzw. Profillänge

\* pro Lauf

\*\* pro Lauf (Gleiterkette, Endhalter und Stechhaken)

## WANDMONTAGE

### 4. Länge

1-2102-116-200

Länge cm	Anzahl Träger	Ringe Gleiter pro Lauf	1-Lauf		2-Lauf		3-Lauf		4-Lauf			5-Lauf			Aufpreis* HB-Klickgleiter	Aufpreis** Set Gleiterkette
			A	B	A	B	A	B	A	B	C	A	B	C		
100	2	16	163	178	275	298	260	277	148	157	156	245	256	262	4	49
120	2	18	171	187	292	316	276	293	155	164	165	260	270	279	4	49
140	2	20	180	196	310	334	292	309	162	171	173	274	284	296	4	48
160	2	24	192	209	334	360	312	329	170	178	183	290	298	316	5	48
180	3	26	230	251	391	421	367	388	206	218	220	343	355	371	6	48
200	3	28	239	260	408	439	383	404	214	225	229	358	369	388	6	48
220	3	32	251	273	433	465	403	424	221	232	239	373	383	408	7	59
240	3	34	260	282	450	483	419	440	229	239	247	388	397	424	7	59
260	3	36	268	291	467	501	435	456	236	246	255	403	411	441	8	59
280	3	40	281	305	492	528	455	476	244	253	265	418	425	461	8	58
300	3	42	289	314	509	546	471	492	251	260	273	433	439	477	9	58
320	3	44	298	323	526	564	487	508	259	267	282	448	453	494	9	74
340	3	46	306	332	543	582	503	524	266	274	290	463	466	511	10	74
360	4	48	344	374	600	643	558	583	302	314	327	516	523	566	10	74
380	4	52	356	387	624	669	578	603	310	321	337	532	537	586	11	73
400	4	54	365	396	642	687	594	619	317	328	346	546	551	603	11	73
420	4	56	374	405	659	705	610	635	325	335	354	561	565	620	12	89
440	4	60	386	418	684	732	630	656	332	342	364	576	579	639	12	88
460	4	62	395	427	701	750	646	671	340	349	372	591	593	656	13	88
480	4	64	403	436	718	768	662	687	347	356	381	606	607	673	13	88
500	4	68	416	449	743	794	682	708	355	363	390	621	621	692	14	88
520	4	72	428	462	768	820	702	728	362	370	400	636	636	712	15	99
540	5	74	466	504	824	881	757	787	399	410	438	690	692	768	15	99
560	5	76	474	513	841	899	773	803	406	417	446	705	706	785	16	99
580	5	80	487	527	866	926	793	823	414	424	456	720	720	804	16	98
Abzug per Wandlager			-26	-30	-27	-31	-27	-31	-26	-30	-26	-27	-31	-27		

Ø 20 mm

Länge cm	Anzahl Träger	Ringe Gleiter pro Lauf	1-Lauf		2-Lauf		3-Lauf		4-Lauf			5-Lauf			Aufpreis* HB-Klickgleiter	Aufpreis** Set Gleiterkette
			A	B	A	B	A	B	A	B	C	A	B	C		
100	2	16	181	198	279	304	264	283	166	177	174	249	262	266	4	49
120	2	18	189	207	296	322	280	299	173	184	183	264	276	283	4	49
140	2	20	198	216	314	340	296	315	180	191	191	278	290	300	4	48
160	2	24	210	229	338	366	316	335	188	198	201	294	304	320	5	48
180	3	26	248	271	395	427	371	394	224	238	238	347	361	375	6	48
200	3	28	257	280	412	445	387	410	232	245	247	362	375	392	6	48
220	3	32	269	293	437	471	407	430	239	252	257	377	389	412	7	59
240	3	34	278	302	454	489	423	446	247	259	265	392	403	428	7	59
260	3	36	286	311	471	507	439	462	254	266	273	407	417	445	8	59
280	3	40	299	325	496	534	459	482	262	273	283	422	431	465	8	58
300	3	42	307	334	513	552	475	498	269	280	291	437	445	481	9	58
320	3	44	316	343	530	570	491	514	277	287	300	452	459	498	9	74
340	3	46	324	352	547	588	507	530	284	294	308	467	472	515	10	74
360	4	48	362	394	604	649	562	589	320	334	345	520	529	570	10	74
380	4	52	374	407	628	675	582	609	328	341	355	536	543	590	11	73
400	4	54	383	416	646	693	598	625	335	348	364	550	557	607	11	73
420	4	56	392	425	663	711	614	641	343	355	372	565	571	624	12	89
440	4	60	404	438	688	738	634	662	350	362	382	580	585	643	12	88
460	4	62	413	447	705	756	650	677	358	369	390	595	599	660	13	88
480	4	64	421	456	722	774	666	693	365	376	399	610	613	677	13	88
500	4	68	434	469	747	800	686	714	373	383	408	625	627	696	14	88
520	4	72	446	482	772	826	706	734	380	390	418	640	642	716	15	99
540	5	74	484	524	828	887	761	793	417	430	456	694	698	772	15	99
560	5	76	492	533	845	905	777	809	424	437	464	709	712	789	16	99
580	5	80	505	547	870	932	797	829	432	444	474	724	726	808	16	98
Abzug per Wandlager			-35	-40	-29	-34	-29	-34	-35	-40	-35	-29	-34	-29		

Wellenband und Gleiterkette sowie Zubehör ab Seite 24

Bestellangaben: System, Garnitur-Nr., Farbcode, Länge · Unverbindlich empfohlene Verkaufspreise in € inkl. MwSt. | Stand 11.2022



# Ø 20 mm Garnituren mit Holzoptik

VION

WAND- UND DECKENMONTAGE / PROFIL 1-/2-LAUF

## BESTELLSCHRITTE

### 1. System







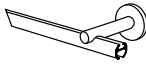
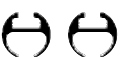
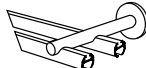

4-2120-116/221-200

### 2. Garnitur-Nr.

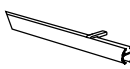
4-2120-116/221-200

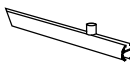
### 3. Farbcode

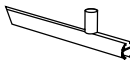
4-2120-116/221-200

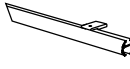
- 4-   Wandabstand 65 mm
- 5-   Wandabstand 65/120 mm
- 6-   Deckenabstand 21 mm
- 7-   Deckenabstand 33 mm
- 8-   Deckenabstand 53 mm
- 11-   Deckenabstand 21 mm



**LINE**  
bündig  
2190

PG A



-116 / -221  
edelstahl / buche



-116 / -222  
edelstahl / wildeiche



-116 / -223  
edelstahl / zwetschge



-108 / -221  
silber / buche



-108 / -222  
silber / wildeiche

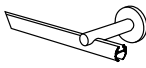
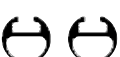
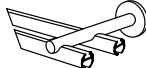

-108 / -223  
silber / zwetschge

- 4-   Wandabstand 65 mm
- 5-   Wandabstand 65/120 mm



**FALA**  
bündig  
2120



**SOLA**  
bündig  
2122

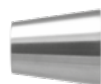

**ORIM**  
bündig  
2124

PG A



-116 / -221  
edelstahl / buche



-116 / -222  
edelstahl / wildeiche



-116 / -223  
edelstahl / zwetschge



-108 / -221  
silber / buche



-108 / -222  
silber / wildeiche



-108 / -223  
silber / zwetschge

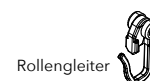

Rollenleiter

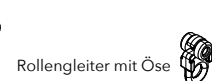

Rollenleiter mit Öse

Alle Garnituren inkl. Standard-Rollenleiter (Art.-Nr. 741-08) alternativ Rollenleiter mit Öse (Art.-Nr. 748-08) ohne Aufpreis.

## HINWEISE

Länge cm = Profillänge

Deckenabstand = Oberkante Deckenträger bis Unterkante Profil

\* pro Lauf, \*\* pro Lauf (Gleiterkette, Endhalter und Stechhaken)

## WAND- UND DECKENMONTAGE

### 4. Länge

4-2120-116/221-200

Länge cm	Anzahl Träger	Gleiter pro Lauf	4- 1-Lauf A	5- 2-Lauf A	6- 1-Lauf A	7- 1-Lauf A	8- 1-Lauf A	11- 1-Lauf A	Aufpreis* HB-Klickgleiter	Aufpreis** Set Gleiterkette
100	2	16	138	238	102	116	120	96	4	49
120	2	18	146	253	110	124	128	104	4	49
140	2	20	153	268	117	131	135	111	4	48
160	2	24	162	285	126	140	144	120	5	48
180	3	26	198	339	144	165	171	135	6	48
200	3	28	206	355	152	173	179	143	6	48
220	3	32	214	371	160	181	187	151	7	59
240	3	34	222	386	168	189	195	159	7	59
260	3	36	230	402	176	197	203	167	8	59
280	3	40	238	418	184	205	211	175	8	58
300	3	42	246	434	192	213	219	183	9	58
320	3	44	253	449	199	220	226	190	9	74
340	3	46	261	464	207	228	234	198	10	74
360	4	48	298	519	226	254	262	214	10	74
380	4	52	306	535	234	262	270	222	11	73
400	4	54	314	551	242	270	278	230	11	73
420	4	56	321	566	249	277	285	237	12	89
440	4	60	329	582	257	285	293	245	12	88
460	4	62	337	598	265	293	301	253	13	88
480	4	64	345	613	273	301	309	261	13	88
500	4	68	353	630	281	309	317	269	14	88
520	4	72	361	646	289	317	325	277	15	99
540	5	74	398	700	308	343	353	293	15	99
560	5	76	406	716	316	351	361	301	16	99
580	5	80	414	732	324	359	369	309	16	98
Abzug / Aufschlag per Wandlager			-20	-21	-2	-9	-11	1		

Ø 20 mm

Länge cm	Anzahl Träger	Gleiter pro Lauf	4- 1-Lauf A	5- 2-Lauf A	Aufpreis* HB-Klickgleiter	Aufpreis** Set Gleiterkette
100	2	16	150	250	4	49
120	2	18	158	265	4	49
140	2	20	165	280	4	48
160	2	24	174	297	5	48
180	3	26	210	351	6	48
200	3	28	218	367	6	48
220	3	32	226	383	7	59
240	3	34	234	398	7	59
260	3	36	242	414	8	59
280	3	40	250	430	8	58
300	3	42	258	446	9	58
320	3	44	265	461	9	74
340	3	46	273	476	10	74
360	4	48	310	531	10	74
380	4	52	318	547	11	73
400	4	54	326	563	11	73
420	4	56	333	578	12	89
440	4	60	341	594	12	88
460	4	62	349	610	13	88
480	4	64	357	625	13	88
500	4	68	365	642	14	88
520	4	72	373	658	15	99
540	5	74	410	712	15	99
560	5	76	418	728	16	99
580	5	80	426	744	16	98
Abzug per Wandlager			-26	-27		

Wellenband und Gleiterkette sowie Zubehör ab Seite 24

Bestellangaben: System, Garnitur-Nr., Farbcode, Länge · Unverbindlich empfohlene Verkaufspreise in € inkl. MwSt. | Stand 11.2022



# Ø 20 mm Einzelteile

VION

	ARTIKEL	OBERFLÄCHE	ART.-NR.	€/STCK.	
	<b>EDELSTAHL-ROHR</b>	edelstahl	800-20-116	Zuschnitt €/m 24,00	Lagerlänge €/m 20,00
	<b>ALUMINIUM-ROHR</b> Ø 20 mm Preis € per Meter Lagerlänge 6 m	weiß	800-20-28	24,00	20,00
		silber	-108	24,00	20,00
		gold	-109	24,00	20,00
		bronze	-132	24,00	20,00
		schwarz matt	-157	24,00	20,00
	<b>ALUMINIUM-PROFIL</b>	edelstahl	808-20-116	Zuschnitt €/m 36,00	Lagerlänge €/m 30,00
	<b>ALUMINIUM-PROFIL</b> Ø 20 mm Preis € per Meter Lagerlänge 6 m	weiß	-28	33,60	28,00
		silber	-108	33,60	28,00
		gold	-109	33,60	28,00
		bronze	-132	33,60	28,00
		schwarz matt	-157	33,60	28,00
		struktur weiß	-328	33,60	28,00
		struktur schwarz	-357	33,60	28,00
	<b>ALUMINIUM-PROFIL MIT HOLZOPTIK</b>	buche	808-20-221	Zuschnitt €/m 36,00	Lagerlänge €/m 30,00
	<b>ALUMINIUM-PROFIL MIT HOLZOPTIK</b> Ø 20 mm Preis € per Meter Lagerlänge 6 m	wildeiche	-222	36,00	30,00
		zwetschge	-223	36,00	30,00
	<b>ENDKAPPE ALBA</b>	edelstahl	203000-116		12,00
	für Ø 20 mm VE = 10 Stück	weiß	-28		12,00
		silber	-108		12,00
		gold	-109		14,00
		bronze	-132		14,00
		schwarz matt	-157		12,00
		struktur weiß	-328		12,00
struktur schwarz	-357		12,00		
	<b>ENDKAPPE LINE</b>	edelstahl	203100-116		19,00
	für Ø 20 mm bündig VE = 10 Stück	weiß	-28		19,00
		silber	-108		19,00
		gold	-109		21,00
		bronze	-132		21,00
		schwarz matt	-157		19,00
		struktur weiß	-328		19,00
struktur schwarz	-357		19,00		
	<b>ENDSTÜCK MELO</b>	edelstahl	203013-116		24,00
	für Ø 20 mm VE = 10 Stück	weiß	-28		24,00
		silber	-108		24,00
		gold	-109		26,00
		bronze	-132		26,00
		schwarz matt	-157		24,00
		struktur weiß	-328		24,00
struktur schwarz	-357		24,00		
	<b>ENDSTÜCK FULA</b>	edelstahl	203014-116		31,00
	für Ø 20 mm VE = 10 Stück	silber	-108		31,00
		gold	-109		33,00
		bronze	-132		33,00
		schwarz matt	-157		31,00
	<b>ENDSTÜCK TELO</b>	edelstahl	203015-116		31,00
	für Ø 20 mm VE = 10 Stück	silber	-108		31,00
		gold	-109		33,00
		bronze	-132		33,00
		schwarz matt	-157		31,00
	<b>ENDSTÜCK FALA</b>	edelstahl	203030-116		25,00
	für Ø 20 mm bündig VE = 10 Stück	weiß	-28		25,00
		silber	-108		25,00
		schwarz matt	-157		25,00
		struktur weiß	-328		25,00
struktur schwarz	-357		25,00		



Unverbindlich empfohlene Verkaufspreise in € inkl. MwSt. | Stand 11.2022

# Ø 20 mm Einzelteile

	ARTIKEL	OBERFLÄCHE	ART.-NR.	€/STCK.
	<b>ENDSTÜCK ORIM</b> für Ø 20 mm bündig  VE = 10 Stück	edelstahl	203031-116	25,00
		weiß	-28	25,00
	<b>ENDSTÜCK SOLA</b> für Ø 20 mm bündig  VE = 10 Stück	edelstahl	203033-116	25,00
		weiß	-28	25,00
	<b>ENDSTÜCK LANA</b> für Ø 20 mm  VE = 10 Stück	edelstahl	203020-116	34,00
		weiß	-28	34,00
	<b>ENDSTÜCK ELANO</b> für Ø 20 mm  VE = 10 Stück	edelstahl	203021-116	34,00
		weiß	-28	34,00
	<b>WANDTRÄGER ALUX (System 1- + 4-)</b> 1-läufig, Wandabstand 65 mm ohne Abdeckung (Art.-Nr. 165001) für Ø 20 mm Rohre / Profile  VE = 10 Stück	edelstahl	204065-116	29,00
		weiß	-28	29,00
	<b>WANDTRÄGER ALUX</b> 1-läufig, Wandabstand 120 mm ohne Abdeckung (Art.-Nr. 165001) für Ø 20 mm Rohre / Profile  VE = 10 Stück	edelstahl	204120-116	35,00
		weiß	-28	35,00
	<b>WANDTRÄGER ALUX</b> 1-läufig, Wandabstand 150 mm ohne Abdeckung (Art.-Nr. 165001) für Ø 20 mm Rohre / Profile  VE = 10 Stück	edelstahl	214150-116	39,00
		silber	-108	39,00
	<b>WANDTRÄGER ALUX (System 2- + 5-)</b> 2-läufig, Wandabstand 65/120 mm ohne Abdeckung (Art.-Nr. 165001) für Ø 20 mm Rohre/Profile  VE = 10 Stück	edelstahl	205120-116	39,00
		weiß	-28	39,00
	<b>KOMBI-WANDTRÄGER ALUX (System 3-)</b> 2-läufig, Wandabstand 65/120 mm 1. Lauf Rohr / 2. Lauf Profil für Ø 20 mm Rohre/Profile  VE = 10 Stück	edelstahl	205220-116	39,00
		silber	-108	39,00

Ø 20 mm

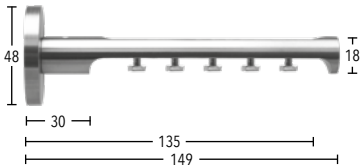
# Ø 20 mm Einzelteile

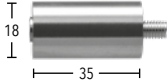
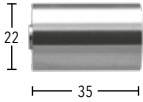
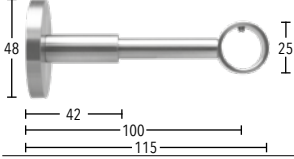
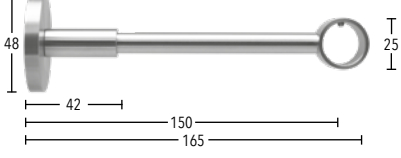
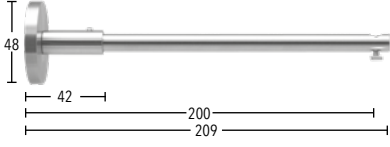
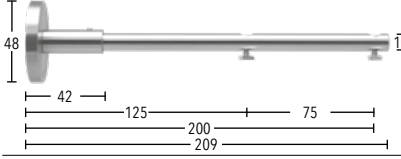
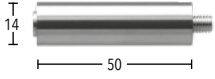
	ARTIKEL	OBERFLÄCHE	ART.-NR.	€ / STCK.
	<b>MULTI-WANDTRÄGER ALUX</b> zur Befestigung von 1-5 Profilen Wandabstand 40-135 mm für Ø 20 mm	edelstahl weiß silber schwarz matt	205320-116 -28 -108 -157	50,00 50,00 50,00 50,00
	VE = 10 Stück			
	<b>ABDECKUNG FÜR ALLE TRÄGER ALUX</b> aus Edelstahl bzw. Aluminium zur Abdeckung der Bohrungen bei Verwendung als Rohrträger	edelstahl weiß silber gold bronze schwarz matt	165001-116 -28 -108 -109 -132 -157	5,00 5,00 5,00 6,00 6,00 5,00
	VE = 10 Stück			
	<b>TRÄGERVERLÄNGERUNG</b> Länge 35 mm für alle Träger ALUX	edelstahl weiß silber gold bronze schwarz matt struktur weiß struktur schwarz	166035-116 -28 -108 -109 -132 -157 -328 -357	13,00 13,00 13,00 15,00 15,00 13,00 13,00 13,00
	VE = 10 Stück			
	<b>TRÄGERAUFNAHME</b> für gekürzte Träger ALUX	edelstahl	167002-116	14,00
	VE = 10 Stück			
	<b>WANDTRÄGER GEO</b> 1-läufig, Wandabstand 100 mm, kürzbar für Ø 20 mm Rohre	edelstahl schwarz matt	204100-116 -157	40,00 40,00
	VE = 10 Stück			
	<b>WANDTRÄGER GEO</b> 1-läufig, Wandabstand 150 mm, kürzbar für Ø 20 mm Rohre	edelstahl schwarz matt	204150-116 -157	44,00 44,00
	VE = 10 Stück			
	<b>WANDTRÄGER GEO</b> 1-läufig, Wandabstand 200 mm, kürzbar für Ø 20 mm Profile	edelstahl weiß bronze schwarz matt	284500-116 -28 -132 -157	38,00 38,00 42,00 38,00
	VE = 6 Stück			
	<b>WANDTRÄGER GEO</b> 2-läufig, Wandabstand 125 / 200 mm, kürzbar für Ø 20 mm Profile	edelstahl schwarz matt	285500-116 -157	40,00 40,00
	VE = 6 Stück			
	<b>TRÄGERVERLÄNGERUNG</b> Länge 50 mm für alle Träger GEO	edelstahl weiß bronze schwarz matt	166050-116 -28 -132 -157	14,00 14,00 16,00 14,00
	VE = 10 Stück			

# Ø 20 mm Einzelteile

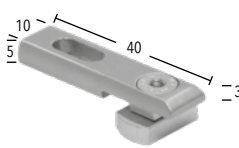
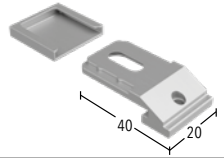
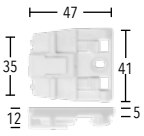
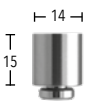
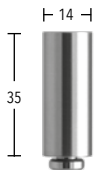
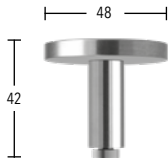
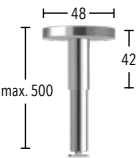
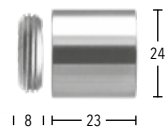
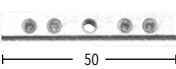
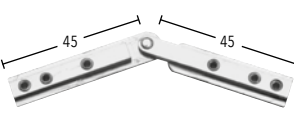
	ARTIKEL	OBERFLÄCHE	ART.-NR.	€ / STCK.
	<b>DECKENTRÄGER 3 mm (System 6-)</b> 1-läufig, Deckenabstand 21 mm für Profile  VE = 10 Stück	silber weiß schwarz	11592-00 -28 -157	11,00 11,00 11,00
	<b>DECKENTRÄGER 3 mm (System 11-)</b> inklusive Bohrlochabdeckung 1-läufig, Deckenabstand 21 mm für Profile  VE = 10 Stück	silber weiß schwarz	11597-00 -28 -157	8,00 8,00 8,00
	<b>KLICK-DECKENTRÄGER 5 mm (System 10-)</b> 1-läufig, Deckenabstand 23 mm Material: Kunststoff für Profile  VE = 10 Stück	weiß	11693-00	11,00
	<b>DECKENTRÄGER 15 mm (System 7-)</b> 1-läufig, Deckenabstand 33 mm für Profile  VE = 10 Stück	edelstahl weiß silber gold bronze schwarz matt struktur weiß struktur schwarz	164915-116 -28 -108 -109 -132 -157 -328 -357	18,00 18,00 18,00 20,00 20,00 18,00 18,00 18,00
	<b>DECKENTRÄGER 35 mm (System 8-)</b> 1-läufig, Deckenabstand 53 mm für Profile  VE = 10 Stück	edelstahl weiß silber gold bronze schwarz matt struktur weiß struktur schwarz	164935-116 -28 -108 -109 -132 -157 -328 -357	20,00 20,00 20,00 22,00 22,00 20,00 20,00 20,00
	<b>DECKENTRÄGER 42 mm</b> 1-läufig, Deckenabstand 60 mm mit 3-Loch Montageplatte für Profile  VE = 10 Stück	edelstahl weiß silber gold bronze schwarz matt struktur weiß struktur schwarz	164942-116 -28 -108 -109 -132 -157 -328 -357	29,00 29,00 29,00 34,00 34,00 29,00 29,00 29,00
	<b>DECKENTRÄGER 500 mm</b> 1-läufig, Deckenabstand 60-518 mm (kürzbar) mit 3-Loch Montageplatte für Profile  VE = 1 Stück	edelstahl weiß silber gold schwarz matt struktur weiß struktur schwarz	164995-116 -28 -108 -109 -157 -328 -357	48,00 48,00 48,00 54,00 48,00 48,00 48,00
	<b>WANDLAGER</b> für Ø 20 mm  VE = 10 Stück	edelstahl weiß silber gold bronze schwarz matt struktur weiß struktur schwarz	207001-116 -28 -108 -109 -132 -157 -328 -357	28,00 28,00 28,00 30,00 30,00 28,00 28,00 28,00
	<b>PROFILVERBINDER</b> für Profile VE = 10 Stück	silber	899-3-00	10,00
	<b>PROFILVERBINDER</b> verstellbar für Profile VE = 10 Stück »Gehrungsschnitt siehe Info-Seite 28«	silber	899-3.1-01	24,00

Ø 20 mm

# Ø 20 mm Einzelteile

VION

	ARTIKEL	OBERFLÄCHE	ART.-NR.	€/STCK.
	<b>ROHRVERBINDER</b> für Ø 20 mm Rohre  VE = 10 Stück	weiß	83020-000	12,00
	<b>GELENKVERBINDER</b> für Ø 20 mm Rohre und Profile  VE = 1 Stück	edelstahl schwarz matt	122920-116 -157	55,00 55,00
	<b>FLACHRING</b> Innen-Ø 28 mm, Außen-Ø 32 mm  VE = 100 Stück	edelstahl silber gold bronze schwarz matt	225720-116 -108 -109 -132 -57	1,80 1,80 2,00 2,00 1,80
	<b>FALTENLEGHAKEN ÖSENHAKEN</b> für Flachringe Art.-Nr. 225720  VE = 100 Stück	transparent transparent	718-4-00 722-4-00	0,10 0,10
	<b>FLACHRING MIT KUNSTSTOFFEINLAGE</b> Innen-Ø 32 mm, Außen-Ø 40 mm  VE = 100 Stück	weiß	202040-28	1,80
	<b>FALTENLEGHAKEN</b> für Flachringe Art.-Nr. 202040-28  VE = 100 Stück	weiß	818-6-28	0,10
	<b>FLACHRING MIT KUNSTSTOFFEINLAGE</b> Innen-Ø 27 mm / Außen-Ø 34 mm  VE = 50 Stück	aluminium matt messing matt nickel matt schwarz matt bronziert matt	125820-08 -24 -29 -57 -70	3,20 3,20 3,20 3,20 3,20
	<b>FALTENLEGHAKEN</b> für Flachringe mit Kunststoffeinlage Art.-Nr. 125820  VE = 100 Stück	transparent gold silber schwarz braun	844-00 -24 -29 -57 -70	0,10 0,10 0,10 0,10 0,10
	<b>FLACHRING MIT ÖSE</b> und Kunststoffeinlage Innen-Ø 27 mm / Außen-Ø 34 mm  VE = 50 Stück	aluminium matt messing matt nickel matt schwarz matt bronziert matt	125920-08 -24 -29 -57 -70	4,20 4,20 4,20 4,20 4,20
	<b>GLEITER MIT FALTENLEGHAKEN</b> für Profile  VE = 100 Stück	weiß grau schwarz	739-00 -08 -57	0,10 0,10 0,10

Unverbindlich empfohlene Verkaufspreise in € inkl. MwSt. | Stand 11.2022

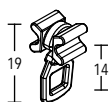
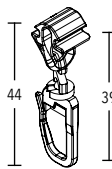
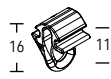
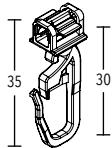
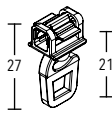
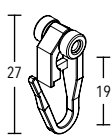
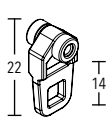
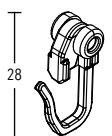
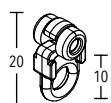
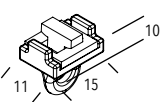
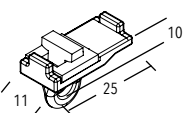
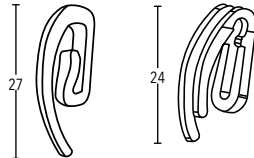

# Ø 20 mm Einzelteile

	ARTIKEL	OBERFLÄCHE	ART.-NR.	€ / STCK.
	<b>GLEITER MIT ÖSE</b> für Profile  VE = 100 Stück	weiß grau schwarz	740-00 -08 -57	0,10 0,10 0,10
 	<b>HB-KLICK-GLEITER MIT FALTENLEGHAKEN drehbar</b> <b>HB-KLICK-GLEITER MIT ÖSE</b> Klick-In / Klick-Out, herausnehmbar für Profile  VE = 100 Stück	weiß weiß	769-00 770-00	0,30 0,30
	<b>KLICK-GLEITER MIT FALTENLEGHAKEN</b> für Profile  VE = 100 Stück	weiß grau schwarz	742-00 -08 -57	0,30 0,30 0,30
	<b>KLICK-GLEITER MIT ÖSE</b> für Profile  VE = 100 Stück	weiß grau schwarz	743-00 -08 -57	0,30 0,30 0,30
	<b>ROLLENGLEITER MIT FALTENLEGHAKEN</b> für Profile  VE = 100 Stück	weiß grau schwarz	741-00 -08 -57	0,25 0,25 0,25
	<b>ROLLENGLEITER MIT ÖSE</b> für Profile  VE = 100 Stück	weiß grau schwarz	748-00 -08 -57	0,25 0,25 0,25
 	<b>ROLLENGLEITER MIT FALTENLEGHAKEN</b> <b>ROLLENGLEITER MIT ÖSE</b> für Profile  VE = 100 Stück	weiß weiß	752-00 751-00	0,80 0,80
	<b>FESTSTELLER "ANTI RUTSCH"</b> für Profile  VE = 100 Stück	weiß grau schwarz	799-20-00 -08 -57	0,80 0,80 0,80
	<b>FESTSTELLER "ANTI RUTSCH"</b> zur Abdeckung einer Ausklinkung für Profile  VE = 100 Stück	weiß grau schwarz	799-40-00 -08 -57	0,80 0,80 0,80
	<b>STECHHAKEN</b> <b>DOPPEL-STECHHAKEN</b>  VE = 100 Stück	weiß weiß	869-00 853-00	0,10 0,20

Ø 20 mm

33 x 11 mm Base

---

silber

Garnitur-Nr. **33-140-081**

4 mm Gleiterlauf





## Profilgarnituren 1-läufig, Wandmontage



LONDON - silber - Garnitur-Nr. 33-141-081

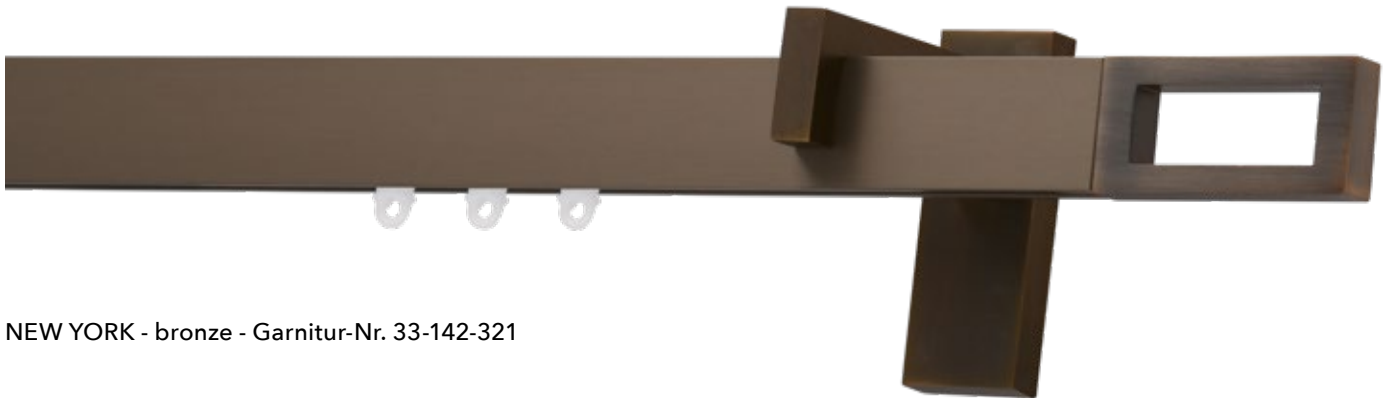

NEW YORK - bronze - Garnitur-Nr. 33-142-321

## Profilgarnituren 2-läufig, Wandmontage



OSLO - schwarz - Garnitur-Nr. 33-240-570







LONDON - edelstahl-optik - Garnitur-Nr. 33-241-161

Profilgarnituren 1-läufig, Wandmontage

Länge	Träger	Gleiter	Garnitur mit ENDKAPPEN	Garnitur mit ENDSTÜCKEN
100 cm	2	16	130	140
120 cm	2	18	138	148
140 cm	2	20	147	157
160 cm	2	24	155	165
180 cm	2	26	164	174
<hr/>				
200 cm	3	28	202	212
220 cm	3	32	210	220
240 cm	3	34	219	229
260 cm	3	36	227	237
280 cm	3	40	236	246
<hr/>				
300 cm	3	42	244	254
320 cm	3	44	252	262
340 cm	3	46	261	271
360 cm	3	48	269	279
380 cm	3	52	278	288
<hr/>				
400 cm	4	54	316	326
420 cm	4	56	324	334
440 cm	4	60	333	343
460 cm	4	62	341	351
480 cm	4	64	350	360
<hr/>				
500 cm	4	68	358	368
520 cm	4	72	367	377
540 cm	4	74	375	385
560 cm	4	76	384	394
580 cm	4	80	392	402
<hr/>				
Abzug per Wandlager			-29	-34

Auswahl Oberflächen:

	-161 edelstahl-optik		-081 silber
	-128 weiß		-321 bronze
			-570 schwarz

Garnitur-Nr. Endkappen

33-140  
Oslo 

Garnitur-Nr. Endstücke

33-141\*  
London 

33-142\*  
New York 

Bestandteile der Garnitur

Profil  
33 x 11 mm 

Träger Base  
WA 80 mm 





Gleiter  
Art.-Nr. 849-00 

\* nicht in -570 schwarz verfügbar

Profilgarnituren 2-läufig, Wandmontage

Länge	Träger	Gleiter	Garnitur mit ENDKAPPEN	Garnitur mit ENDSTÜCKEN
100 cm	2	32	213	223
120 cm	2	36	230	240
140 cm	2	40	247	257
160 cm	2	48	264	274
180 cm	2	52	281	291
<hr/>				
200 cm	3	56	334	344
220 cm	3	64	351	361
240 cm	3	68	368	378
260 cm	3	72	385	395
280 cm	3	80	402	412
<hr/>				
300 cm	3	84	419	429
320 cm	3	88	435	445
340 cm	3	92	452	462
360 cm	3	96	469	479
380 cm	3	104	486	496
<hr/>				
400 cm	4	108	540	550
420 cm	4	112	556	566
440 cm	4	120	574	584
460 cm	4	124	590	600
480 cm	4	128	607	617
<hr/>				
500 cm	4	136	624	634
520 cm	4	144	641	651
540 cm	4	148	658	668
560 cm	4	152	675	685
580 cm	4	160	692	702
<hr/>				
Abzug per Wandlager			-35	-40

Auswahl Oberflächen:

	-161 edelstahl-optik		-081 silber
	-128 weiß		-321 bronze
			-570 schwarz

Garnitur-Nr. Endkappen

33-240  
Oslo 

Garnitur-Nr. Endstücke

33-241\*  
London 

33-242\*  
New York 

Bestandteile der Garnitur

Profil  
33 x 11 mm 

Träger Base  
WA 80/130 mm 

Gleiter  
Art.-Nr. 849-00 

\* nicht in -570 schwarz verfügbar

Bestellangaben: Garnitur-Nr., Farbcode, Länge · Unverbindlich empfohlene Verkaufspreise in EURO inkl. MwSt.

Standardgleiter (Art.-Nr. 849-00)  alternativ Gleiter mit Öse (Art.-Nr. 850-00)  ohne Aufpreis.

## Profilgarnituren 3-läufig, Wandmontage



OSLO - silber - Garnitur-Nr. 33-340-081



NEW YORK - weiß - Garnitur-Nr. 33-342-128

## Profilgarnituren 4-läufig, Wandmontage



OSLO - edelstahl-optik - Garnitur-Nr. 33-440-161



LONDON - bronze - Garnitur-Nr. 33-441-321

Profilgarnituren 3-läufig, Wandmontage

Länge	Träger	Gleiter	Garnitur mit ENDKAPPEN	Garnitur mit ENDSTÜCKEN
100 cm	2	48	289	299
120 cm	2	54	314	324
140 cm	2	60	339	349
160 cm	2	72	365	375
180 cm	2	78	390	400
<hr/>				
200 cm	3	84	455	465
220 cm	3	96	480	490
240 cm	3	102	505	515
260 cm	3	108	531	541
280 cm	3	120	556	566
<hr/>				
300 cm	3	126	581	591
320 cm	3	132	606	616
340 cm	3	138	631	641
360 cm	3	144	657	667
380 cm	3	156	682	692
<hr/>				
400 cm	4	162	747	757
420 cm	4	168	772	782
440 cm	4	180	798	808
460 cm	4	186	823	833
480 cm	4	192	848	858
<hr/>				
500 cm	4	204	874	884
520 cm	4	216	900	910
540 cm	4	222	925	935
560 cm	4	228	950	960
580 cm	4	240	975	985
<hr/>				
Abzug per Wandlager			-37	-42

Auswahl Oberflächen:

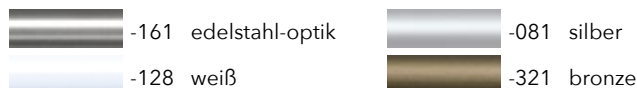

Garnitur-Nr. Endkappen



Garnitur-Nr. Endstücke



Bestandteile der Garnitur

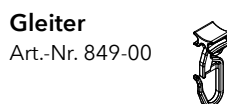
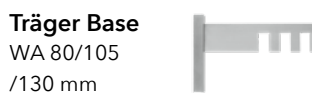
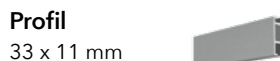

Profilgarnituren 4-läufig, Wandmontage

Länge	Träger	Gleiter	Garnitur mit ENDKAPPEN	Garnitur mit ENDSTÜCKEN
100 cm	2	64	362	372
120 cm	2	72	396	406
140 cm	2	80	429	439
160 cm	2	96	463	473
180 cm	2	104	497	507
<hr/>				
200 cm	3	112	572	582
220 cm	3	128	606	616
240 cm	3	136	640	650
260 cm	3	144	673	683
280 cm	3	160	707	717
<hr/>				
300 cm	3	168	741	751
320 cm	3	176	774	784
340 cm	3	184	808	818
360 cm	3	192	841	851
380 cm	3	208	875	885
<hr/>				
400 cm	4	216	951	961
420 cm	4	224	984	994
440 cm	4	240	1019	1029
460 cm	4	248	1052	1062
480 cm	4	256	1085	1095
<hr/>				
500 cm	4	272	1120	1130
520 cm	4	288	1154	1164
540 cm	4	296	1187	1197
560 cm	4	304	1221	1231
580 cm	4	320	1255	1265
<hr/>				
Abzug per Wandlager			-38	-43

Auswahl Oberflächen:

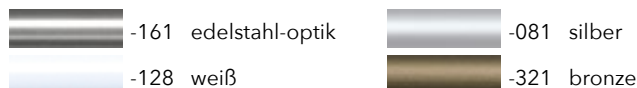

Garnitur-Nr. Endkappen



Garnitur-Nr. Endstücke



Bestandteile der Garnitur

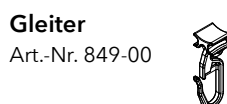
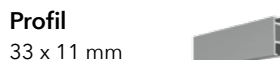

Bestellangaben: Garnitur-Nr., Farbcode, Länge · Unverbindlich empfohlene Verkaufspreise in EURO inkl. MwSt.

Standardgleiter (Art.-Nr. 849-00)  alternativ Gleiter mit Öse (Art.-Nr. 850-00)  ohne Aufpreis.

## Profilgarnituren 1-läufig, Deckenmontage



OSLO - schwarz - Garnitur-Nr. 33-040-570



OSLO - silber - Garnitur-Nr. 33-040-081

## Profilgarnituren 1-läufig, Deckenmontage



OSLO - schwarz - Garnitur-Nr. 33-640-570







LONDON - weiß - Garnitur-Nr. 33-641-128



Profilgarnituren 1-läufig, Deckenmontage

Länge	Träger	Gleiter	Garnitur mit ENDKAPPEN	Garnitur mit ENDSTÜCKEN
100 cm	2	16	98	108
120 cm	2	18	106	116
140 cm	2	20	115	125
160 cm	2	24	123	133
180 cm	2	26	132	142
<hr/>				
200 cm	3	28	154	164
220 cm	3	32	162	172
240 cm	3	34	171	181
260 cm	3	36	179	189
280 cm	3	40	188	198
<hr/>				
300 cm	3	42	196	206
320 cm	3	44	204	214
340 cm	3	46	213	223
360 cm	3	48	221	231
380 cm	3	52	230	240
<hr/>				
400 cm	4	54	252	262
420 cm	4	56	260	270
440 cm	4	60	269	279
460 cm	4	62	277	287
480 cm	4	64	286	296
<hr/>				
500 cm	4	68	294	304
520 cm	4	72	303	313
540 cm	4	74	311	321
560 cm	4	76	320	330
580 cm	4	80	328	338
<hr/>				
Abzug per Wandlager			-13	-18

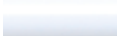
Auswahl Oberflächen:

	-161 edelstahl-optik		-081 silber
	-128 weiß		-321 bronze
			-570 schwarz

Garnitur-Nr. Endkappen

33-040  
Oslo 

Garnitur-Nr. Endstücke

33-041\*  
London 

33-042\*  
New York 

Bestandteile der Garnitur

Profil  
33 x 11 mm 

Deckenträger  
3 mm 





Gleiter  
Art.-Nr. 849-00 

\* nicht in -570 schwarz verfügbar

Profilgarnituren 1-läufig, Deckenmontage

Länge	Träger	Gleiter	Garnitur mit ENDKAPPEN	Garnitur mit ENDSTÜCKEN
100 cm	2	16	98	108
120 cm	2	18	106	116
140 cm	2	20	115	125
160 cm	2	24	123	133
180 cm	2	26	132	142
<hr/>				
200 cm	3	28	154	164
220 cm	3	32	162	172
240 cm	3	34	171	181
260 cm	3	36	179	189
280 cm	3	40	188	198
<hr/>				
300 cm	3	42	196	206
320 cm	3	44	204	214
340 cm	3	46	213	223
360 cm	3	48	221	231
380 cm	3	52	230	240
<hr/>				
400 cm	4	54	252	262
420 cm	4	56	260	270
440 cm	4	60	269	279
460 cm	4	62	277	287
480 cm	4	64	286	296
<hr/>				
500 cm	4	68	294	304
520 cm	4	72	303	313
540 cm	4	74	311	321
560 cm	4	76	320	330
580 cm	4	80	328	338
<hr/>				
Abzug per Wandlager			-13	-18

Auswahl Oberflächen:

	-161 edelstahl-optik		-081 silber
	-128 weiß		-321 bronze
			-570 schwarz

Garnitur-Nr. Endkappen

33-640  
Oslo 

Garnitur-Nr. Endstücke

33-641\*  
London 

33-642\*  
New York 

Bestandteile der Garnitur

Profil  
33 x 11 mm 

Deckenträger  
10 mm 

Gleiter  
Art.-Nr. 849-00 

\* nicht in -570 schwarz verfügbar

Bestellangaben: Garnitur-Nr., Farbcode, Länge · Unverbindlich empfohlene Verkaufspreise in EURO inkl. MwSt.

Standardgleiter (Art.-Nr. 849-00)  alternativ Gleiter mit Öse (Art.-Nr. 850-00)  ohne Aufpreis.

## Profilgarnituren 2-läufig, Deckenmontage



OSLO - edelstahl-optik - Garnitur-Nr. 33-740-161

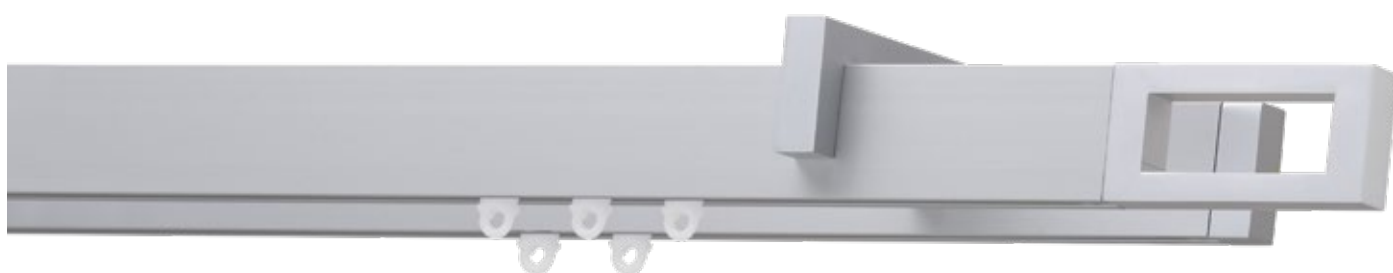

NEW YORK - silber - Garnitur-Nr. 33-742-081

## Profilgarnituren 3-läufig, Deckenmontage



OSLO - bronze - Garnitur-Nr. 33-840-321



LONDON - silber - Garnitur-Nr. 33-841-081

Profilgarnituren 2-läufig, Deckenmontage

Länge	Träger	Gleiter	Garnitur mit ENDKAPPEN	Garnitur mit ENDSTÜCKEN
100 cm	2	32	177	187
120 cm	2	36	194	204
140 cm	2	40	211	221
160 cm	2	48	228	238
180 cm	2	52	245	255
<hr/>				
200 cm	3	56	280	290
220 cm	3	64	297	307
240 cm	3	68	314	324
260 cm	3	72	331	341
280 cm	3	80	348	358
<hr/>				
300 cm	3	84	365	375
320 cm	3	88	381	391
340 cm	3	92	398	408
360 cm	3	96	415	425
380 cm	3	104	432	442
<hr/>				
400 cm	4	108	468	478
420 cm	4	112	484	494
440 cm	4	120	502	512
460 cm	4	124	518	528
480 cm	4	128	535	545
<hr/>				
500 cm	4	136	552	562
520 cm	4	144	569	579
540 cm	4	148	586	596
560 cm	4	152	603	613
580 cm	4	160	620	630
<hr/>				
Abzug per Wandlager			-17	-22

Auswahl Oberflächen:

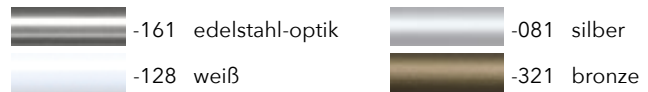

Garnitur-Nr. Endkappen

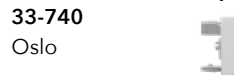

Garnitur-Nr. Endstücke



Bestandteile der Garnitur Profil

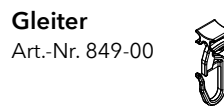

Profilgarnituren 3-läufig, Deckenmontage

Länge	Träger	Gleiter	Garnitur mit ENDKAPPEN	Garnitur mit ENDSTÜCKEN
100 cm	2	48	255	265
120 cm	2	54	280	290
140 cm	2	60	305	315
160 cm	2	72	331	341
180 cm	2	78	356	366
<hr/>				
200 cm	3	84	404	414
220 cm	3	96	429	439
240 cm	3	102	454	464
260 cm	3	108	480	490
280 cm	3	120	505	515
<hr/>				
300 cm	3	126	530	540
320 cm	3	132	555	565
340 cm	3	138	580	590
360 cm	3	144	606	616
380 cm	3	156	631	641
<hr/>				
400 cm	4	162	679	689
420 cm	4	168	704	714
440 cm	4	180	730	740
460 cm	4	186	755	765
480 cm	4	192	780	790
<hr/>				
500 cm	4	204	806	816
520 cm	4	216	832	842
540 cm	4	222	857	867
560 cm	4	228	882	892
580 cm	4	240	907	917
<hr/>				
Abzug per Wandlager			-20	-25

Auswahl Oberflächen:

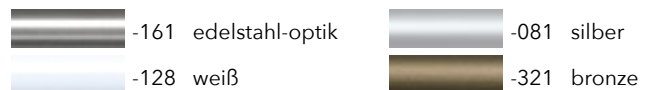

Garnitur-Nr. Endkappen



Garnitur-Nr. Endstücke



Bestandteile der Garnitur Profil

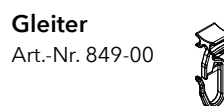
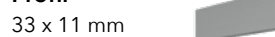

Bestellangaben: Garnitur-Nr., Farbcode, Länge · Unverbindlich empfohlene Verkaufspreise in EURO inkl. MwSt.

Standardgleiter (Art.-Nr. 849-00) alternativ Gleiter mit Öse (Art.-Nr. 850-00) ohne Aufpreis.

Profilgarnituren 4-läufig, Deckenmontage



OSLO - weiß - Garnitur-Nr. 33-940-128



NEW YORK - edelstahl-optik - Garnitur-Nr. 33-942-161

Profilgarnituren 4-läufig, Deckenmontage

Länge	Träger	Gleiter	Garnitur mit ENDKAPPEN	Garnitur mit ENDSTÜCKEN
100 cm	2	64	332	342
120 cm	2	72	366	376
140 cm	2	80	399	409
160 cm	2	96	433	443
180 cm	2	104	467	477
<hr/>				
200 cm	3	112	527	537
220 cm	3	128	561	571
240 cm	3	136	595	605
260 cm	3	144	628	638
280 cm	3	160	662	672
<hr/>				
300 cm	3	168	696	706
320 cm	3	176	729	739
340 cm	3	184	763	773
360 cm	3	192	796	806
380 cm	3	208	830	840
<hr/>				
400 cm	4	216	891	901
420 cm	4	224	924	934
440 cm	4	240	959	969
460 cm	4	248	992	1002
480 cm	4	256	1025	1035
<hr/>				
500 cm	4	272	1060	1070
520 cm	4	288	1094	1104
540 cm	4	296	1127	1137
560 cm	4	304	1161	1171
580 cm	4	320	1195	1205
<hr/>				
Abzug per Wandlager			-23	-28

Auswahl Oberflächen:

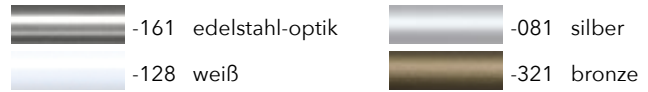

Garnitur-Nr. Endkappen



Garnitur-Nr. Endstücke



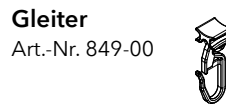
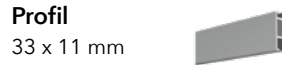

Bestandteile der Garnitur



# 33 x 11 mm Base

	ARTIKEL	OBERFLÄCHE	ARTIKEL-NR.	EURO / STK.
	RECHTECKPROFIL 33x11 mm	edelstahl-optik	8083311-161	34,00
	4 mm Gleiterlauf	weiß	-128	34,00
	Lagerlänge 6 Meter	silber	-081	34,00
	Preis € per Meter	bronze	-321	34,00
		schwarz	-570	34,00
	RECHTECKPROFIL 33x11 mm	edelstahl-optik	8083311-161	40,80
	4 mm Gleiterlauf	weiß	-128	40,80
	Fixlänge (Zuschnitt)	silber	-081	40,80
	Preis € per Meter	bronze	-321	40,80
		schwarz	-570	40,80
	Endkappe	edelstahl-optik	503340-161	13,00
	OSLO	weiß	-128	13,00
	für Rechteckprofil	silber	-081	13,00
	VE = 10 Stück	bronze	-321	13,00
		schwarz	-570	13,00
	Endstück	edelstahl-optik	503341-161	18,00
	LONDON	weiß	-128	18,00
	für Rechteckprofil	silber	-081	18,00
	VE = 10 Stück	bronze	-321	18,00
	Endstück	edelstahl-optik	503342-161	18,00
	NEW YORK	weiß	-128	18,00
	für Rechteckprofil	silber	-081	18,00
	VE = 10 Stück	bronze	-321	18,00
	WANDTRÄGER, 1-läufig	edelstahl-optik	603380-161	30,00
	WA 80 mm, für Rechteckprofil	weiß	-128	30,00
	VE = 10 Stück	silber	-081	30,00
		bronze	-321	30,00
		schwarz	-570	30,00
	WANDTRÄGER, 1-läufig	edelstahl-optik	603313-161	35,00
	WA 130 mm, für Rechteckprofil	weiß	-128	35,00
	VE = 10 Stück	silber	-081	35,00
		bronze	-321	35,00
		schwarz	-570	35,00
	WANDTRÄGER, 2-läufig	edelstahl-optik	623313-161	37,00
	WA 80/130 mm	weiß	-128	37,00
	für Rechteckprofil	silber	-081	37,00
	VE = 10 Stück	bronze	-321	37,00
		schwarz	-570	37,00
	WANDTRÄGER, 3-läufig	edelstahl-optik	633313-161	40,00
	WA 80/105/130 mm	weiß	-128	40,00
	für Rechteckprofil	silber	-081	40,00
	VE = 10 Stück	bronze	-321	40,00

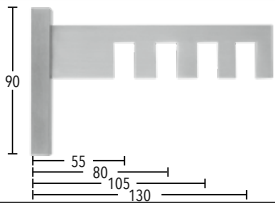
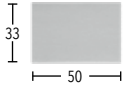
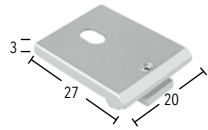
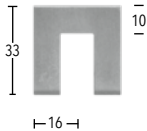
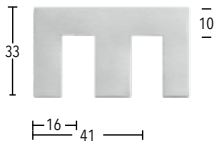
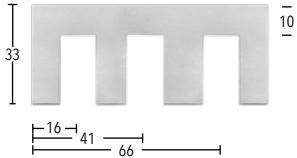
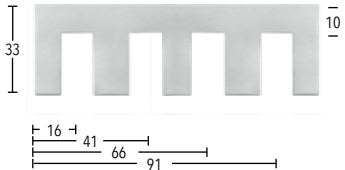
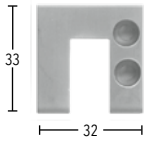
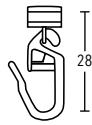
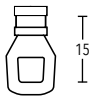
Unverbindlich empfohlene Verkaufspreise in EURO inkl. MwSt.

	ARTIKEL	OBERFLÄCHE	ARTIKEL-NR.	EURO / STK.
	WANDTRÄGER, 4-läufig WA 55/80/105/130 mm für Rechteckprofil VE = 10 Stück	edelstahl-optik weiß silber bronze	643313-161 -128 -081 -321	42,00 42,00 42,00 42,00
	TRÄGERVERLÄNGERUNG Länge 50 mm VE = 10 Stück	edelstahl-optik weiß silber bronze schwarz	403350-161 -128 -081 -321 -570	14,00 14,00 14,00 14,00 14,00
	DECKENTRÄGER 3 mm 1-läufig Deckenabstand 36 mm VE = 10 Stück	silber weiß schwarz	703303-161 -128 -570	14,00 14,00 14,00
	DECKENTRÄGER, 10 mm 1-läufig Deckenabstand 43 mm VE = 10 Stück	edelstahl-optik weiß silber bronze schwarz	703311-161 -128 -081 -321 -570	14,00 14,00 14,00 14,00 14,00
	DECKENTRÄGER, 10 mm 2-läufig Deckenabstand 43 mm VE = 10 Stück	edelstahl-optik weiß silber bronze	723311-161 -128 -081 -321	19,00 19,00 19,00 19,00
	DECKENTRÄGER, 10 mm 3-läufig Deckenabstand 43 mm VE = 10 Stück	edelstahl-optik weiß silber bronze	733311-161 -128 -081 -321	23,00 23,00 23,00 23,00
	DECKENTRÄGER, 10 mm 4-läufig Deckenabstand 43 mm VE = 10 Stück	edelstahl-optik weiß silber bronze	743311-161 -128 -081 -321	27,00 27,00 27,00 27,00
	WANDLAGER VE = 10 Stück	edelstahl-optik weiß silber bronze schwarz	303340-161 -128 -081 -321 -570	14,00 14,00 14,00 14,00 14,00
	GLEITER MIT FALTENLEGHAKEN für 4 mm Gleiterlauf, VE = 100 Stück	weiß	849-00	0,10
	GLEITER MIT ÖSE für 4 mm Gleiterlauf, VE = 100 Stück	weiß	850-00	0,10
	FESTSTELLER für 4 mm Gleiterlauf VE = 100 Stück	weiß	899-8-00	0,50

Ø 16 mm Primo

---

edelstahl-optik

Garnitur-Nr. 16-442-161







Ø 16 mm Primo

# Ø 16 mm Primo

## Ringgarnituren 1-läufig, Wandmontage

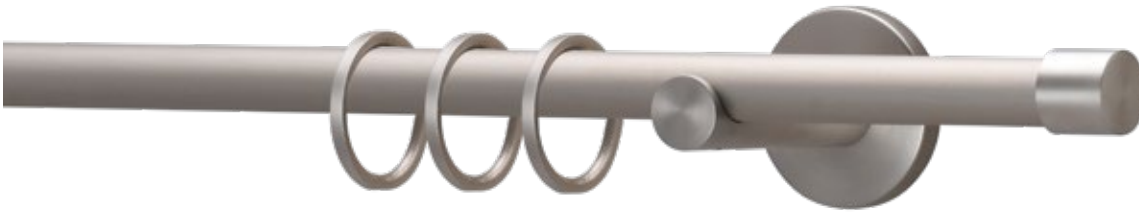

TAPA - edelstahl-optik - Garnitur-Nr. 16-140-161



ELLIPSE - bronze - Garnitur-Nr. 16-143-321

## Ringgarnituren 2-läufig, Wandmontage



DIAGONAL - edelstahl-optik - Garnitur-Nr. 16-244-161



ZYLINDER - bronze - Garnitur-Nr. 16-245-321

Ringgarnituren 1-läufig, Wandmontage

Länge	Träger	Ringe	Garnitur mit ENDKAPPEN	Garnitur mit ENDSTÜCKEN
100 cm	2	16	108	118
120 cm	2	18	117	127
140 cm	2	20	125	135
160 cm	3	24	157	167
180 cm	3	26	165	175
<hr/>				
200 cm	3	28	173	183
220 cm	3	32	185	195
240 cm	3	34	193	203
260 cm	3	36	201	211
280 cm	3	40	213	223
<hr/>				
300 cm	3	42	221	231
320 cm	4	44	249	259
340 cm	4	46	257	267
360 cm	4	48	265	275
380 cm	4	52	277	287
<hr/>				
400 cm	4	54	285	295
420 cm	4	56	294	304
440 cm	4	60	306	316
460 cm	4	62	314	324
480 cm	5	64	342	352
<hr/>				
500 cm	5	68	354	364
520 cm	5	72	366	376
540 cm	5	74	374	384
560 cm	5	76	382	392
580 cm	5	80	394	404
<hr/>				
Abzug per Wandlager			-15	-20

Auswahl Oberflächen:

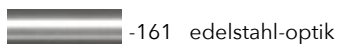

Garnitur-Nr. Endkappen

16-140

Tapa



Garnitur-Nr. Endstücke

16-141

Kegel



16-142

Kugel



16-143

Ellipse



16-144

Diagonal



16-145

Zylinder



Bestandteile der Garnitur

Rohr

Ø 16 mm



Träger Primo

WA 65 mm



Flachring mit

Faltenleghaken



Ø 16 mm Primo

Ringgarnituren 2-läufig, Wandmontage

Länge	Träger	Ringe	Garnitur mit ENDKAPPEN	Garnitur mit ENDSTÜCKEN
100 cm	2	32	196	206
120 cm	2	36	213	223
140 cm	2	40	229	239
160 cm	3	48	283	293
180 cm	3	52	299	309
<hr/>				
200 cm	3	56	315	325
220 cm	3	64	339	349
240 cm	3	68	355	365
260 cm	3	72	372	382
280 cm	3	80	395	405
<hr/>				
300 cm	3	84	412	422
320 cm	4	88	458	468
340 cm	4	92	474	484
360 cm	4	96	490	500
380 cm	4	104	514	524
<hr/>				
400 cm	4	108	530	540
420 cm	4	112	547	557
440 cm	4	120	571	581
460 cm	4	124	587	597
480 cm	5	128	633	643
<hr/>				
500 cm	5	136	657	667
520 cm	5	144	681	691
540 cm	5	148	697	707
560 cm	5	152	713	723
580 cm	5	160	737	747
<hr/>				
Abzug per Wandlager			-20	-25

Auswahl Oberflächen:

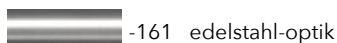

Garnitur-Nr. Endkappen

16-240

Tapa



Garnitur-Nr. Endstücke

16-241

Kegel



16-242

Kugel



16-243

Ellipse



16-244

Diagonal



16-245

Zylinder



Bestandteile der Garnitur

Rohr

Ø 16 mm



Träger Primo

WA 65/120 mm



Flachring mit

Faltenleghaken



# Ø 16 mm Primo

## Profilgarnituren 1-läufig, Wandmontage



KEGEL - edelstahl-optik - Garnitur-Nr. 16-441-161



KUGEL - bronze - Garnitur-Nr. 16-442-321

## Profilgarnituren 2-läufig, Wandmontage



ELLIPSE - edelstahl-optik - Garnitur-Nr. 16-543-161



TAPA - bronze - Garnitur-Nr. 16-540-321

Profilgarnituren 1-läufig, Wandmontage

Länge	Träger	Gleiter	Garnitur mit ENDKAPPEN	Garnitur mit ENDSTÜCKEN
100 cm	2	16	88	98
120 cm	2	18	94	104
140 cm	2	20	100	110
160 cm	3	24	126	136
180 cm	3	26	132	142
<hr/>				
200 cm	3	28	138	148
220 cm	3	32	144	154
240 cm	3	34	150	160
260 cm	3	36	156	166
280 cm	3	40	162	172
<hr/>				
300 cm	3	42	168	178
320 cm	4	44	194	204
340 cm	4	46	200	210
360 cm	4	48	206	216
380 cm	4	52	212	222
<hr/>				
400 cm	4	54	218	228
420 cm	4	56	224	234
440 cm	4	60	230	240
460 cm	4	62	236	246
480 cm	5	64	262	272
<hr/>				
500 cm	5	68	268	278
520 cm	5	72	274	284
540 cm	5	74	280	290
560 cm	5	76	286	296
580 cm	5	80	293	303
<hr/>				
Abzug per Wandlager			-15	-20

Auswahl Oberflächen:

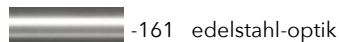

Garnitur-Nr. Endkappen

16-440

Tapa



Garnitur-Nr. Endstücke

16-441

Kegel



16-442

Kugel



16-443

Ellipse



16-444

Diagonal



16-445

Zylinder



Bestandteile der Garnitur

Profil

Ø 16 mm



Träger Primo

WA 65 mm



Gleiter

Art.-Nr. 739



Profilgarnituren 2-läufig, Wandmontage

Länge	Träger	Gleiter	Garnitur mit ENDKAPPEN	Garnitur mit ENDSTÜCKEN
100 cm	2	32	155	165
120 cm	2	36	167	177
140 cm	2	40	179	189
160 cm	3	48	221	231
180 cm	3	52	233	243
<hr/>				
200 cm	3	56	245	255
220 cm	3	64	258	268
240 cm	3	68	270	280
260 cm	3	72	281	291
280 cm	3	80	294	304
<hr/>				
300 cm	3	84	306	316
320 cm	4	88	348	358
340 cm	4	92	360	370
360 cm	4	96	371	381
380 cm	4	104	384	394
<hr/>				
400 cm	4	108	396	406
420 cm	4	112	408	418
440 cm	4	120	420	430
460 cm	4	124	432	442
480 cm	5	128	474	484
<hr/>				
500 cm	5	136	486	496
520 cm	5	144	498	508
540 cm	5	148	510	520
560 cm	5	152	522	532
580 cm	5	160	535	545
<hr/>				
Abzug per Wandlager			-20	-25

Auswahl Oberflächen:

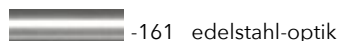

Garnitur-Nr. Endkappen

16-540

Tapa



Garnitur-Nr. Endstücke

16-541

Kegel



16-542

Kugel



16-543

Ellipse



16-544

Diagonal



16-545

Zylinder



Bestandteile der Garnitur

Profil

Ø 16 mm



Träger Primo

WA 65/120 mm



Gleiter

Art.-Nr. 739



Bestellangaben: Garnitur-Nr., Farbcode, Länge · Unverbindlich empfohlene Verkaufspreise in EURO inkl. MwSt.

Standardgleiter (Art.-Nr. 739-xx)  alternativ Gleiter mit Öse (Art.-Nr. 740-xx)  ohne Aufpreis.

# Ø 16 mm Primo

Profilgarnituren 1-läufig, Deckenmontage



TAPA - edelstahl-optik - Garnitur-Nr. 16-640-161



TAPA - bronze - Garnitur-Nr. 16-640-321

Profilgarnituren 1-läufig, Deckenmontage



KUGEL - edelstahl-optik - Garnitur-Nr. 16-742-161



KEGEL - bronze - Garnitur-Nr. 16-741-321

Profilgarnituren 1-läufig, Deckenmontage

Länge	Träger	Gleiter	Garnitur mit ENDKAPPEN
100 cm	2	16	64
120 cm	2	18	70
140 cm	2	20	76
160 cm	3	24	90
180 cm	3	26	96
<hr/>			
200 cm	3	28	102
220 cm	3	32	108
240 cm	3	34	114
260 cm	3	36	120
280 cm	3	40	126
<hr/>			
300 cm	3	42	132
320 cm	4	44	146
340 cm	4	46	152
360 cm	4	48	158
380 cm	4	52	164
<hr/>			
400 cm	4	54	170
420 cm	4	56	176
440 cm	4	60	182
460 cm	4	62	188
480 cm	5	64	202
<hr/>			
500 cm	5	68	208
520 cm	5	72	214
540 cm	5	74	220
560 cm	5	76	226
580 cm	5	80	232
<hr/>			
Abzug per Wandlager			-3

Auswahl Oberflächen:



Garnitur-Nr. Endkappen

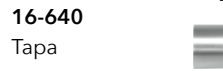

Bestandteile der Garnitur

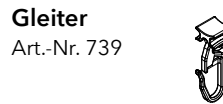

Profilgarnituren 1-läufig, Deckenmontage

Länge	Träger	Gleiter	Garnitur mit ENDKAPPEN	Garnitur mit ENDSTÜCKEN
100 cm	2	16	88	98
120 cm	2	18	94	104
140 cm	2	20	100	110
160 cm	3	24	126	136
180 cm	3	26	132	142
<hr/>				
200 cm	3	28	138	148
220 cm	3	32	144	154
240 cm	3	34	150	160
260 cm	3	36	156	166
280 cm	3	40	162	172
<hr/>				
300 cm	3	42	168	178
320 cm	4	44	194	204
340 cm	4	46	200	210
360 cm	4	48	206	216
380 cm	4	52	212	222
<hr/>				
400 cm	4	54	218	228
420 cm	4	56	224	234
440 cm	4	60	230	240
460 cm	4	62	236	246
480 cm	5	64	262	272
<hr/>				
500 cm	5	68	268	278
520 cm	5	72	274	284
540 cm	5	74	280	290
560 cm	5	76	286	296
580 cm	5	80	293	303
<hr/>				
Abzug per Wandlager			-15	-20

Auswahl Oberflächen:



Garnitur-Nr. Endkappen

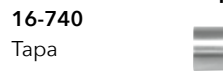

Garnitur-Nr. Endstücke



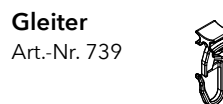

Bestandteile der Garnitur



Bestellangaben: Garnitur-Nr., Farbcode, Länge · Unverbindlich empfohlene Verkaufspreise in EURO inkl. MwSt.

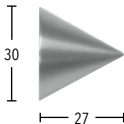
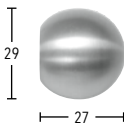
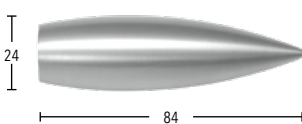
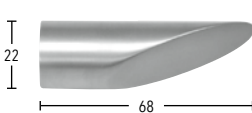

Standardgleiter (Art.-Nr. 739-xx) alternativ Gleiter mit Öse (Art.-Nr. 740-xx) ohne Aufpreis.

# Ø 16 mm Primo

	ARTIKEL	OBERFLÄCHE	ARTIKEL-NR.	EURO / STK.
	ALUMINIUM-ROHR Ø 16 mm Lagerlänge 6 Meter Preis € per Meter	edelstahl-optik bronze	8016-161 -321	18,00 18,00
	ALUMINIUM-ROHR Ø 16 mm Fixlänge (Zuschnitt) Preis € per Meter	edelstahl-optik bronze	8016-161 -321	21,60 21,60
	ALUMINIUM-PROFIL Ø 16 mm Lagerlänge 6 Meter Preis € per Meter	edelstahl-optik bronze	8816-161 -321	24,00 24,00
	ALUMINIUM-PROFIL Ø 16 mm Fixlänge (Zuschnitt) Preis € per Meter	edelstahl-optik bronze	8816-161 -321	28,80 28,80
	Endkappe TAPA für Ø 16 mm VE = 10 Stück	edelstahl-optik bronze	501640-161 -321	8,00 8,00
	Endstück KEGEL für Ø 16 mm VE = 10 Stück	edelstahl-optik bronze	501641-161 -321	13,00 13,00
	Endstück KUGEL für Ø 16 mm VE = 10 Stück	edelstahl-optik bronze	501642-161 -321	13,00 13,00
	Endstück ELLIPSE für Ø 16 mm VE = 10 Stück	edelstahl-optik bronze	501643-161 -321	13,00 13,00
	Endstück DIAGONAL für Ø 16 mm VE = 10 Stück	edelstahl-optik bronze	501644-161 -321	13,00 13,00

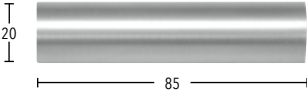
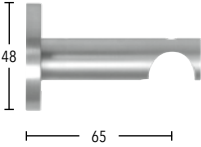
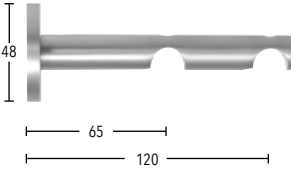
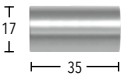
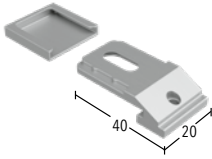

Unverbindlich empfohlene Verkaufspreise in EURO inkl. MwSt.

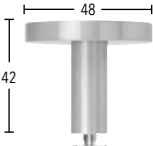
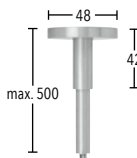

	ARTIKEL	OBERFLÄCHE	ARTIKEL-NR.	EURO / STK.
	Endstück	edelstahl-optik	501645-161	13,00
	ZYLINDER für Ø 16 mm VE = 10 Stück	bronze	-321	13,00
	WANDTRÄGER, 1-läufig	edelstahl-optik	601665-161	20,00
	WA 65 mm für Ø 16 mm Rohre und Profile VE = 10 Stück	bronze	-321	20,00
	WANDTRÄGER, 2-läufig	edelstahl-optik	601612-161	30,00
	WA 65/120 mm für Ø 16 mm Rohre und Profile VE = 10 Stück	bronze	-321	30,00
	TRÄGERVERLÄNGERUNG	edelstahl-optik	401635-161	13,00
	Länge 35 mm VE = 10 Stück	bronze	-321	13,00
	DECKENTRÄGER 3 mm	weiß	702013-128	8,00
	1-läufig Deckenabstand 16 mm VE = 10 Stück	grau schwarz	-161 -570	8,00 8,00
	DECKENTRÄGER 15 mm	edelstahl-optik	702015-161	18,00
	1-läufig Deckenabstand 28 mm VE = 10 Stück	bronze	-321	20,00
	DECKENTRÄGER 35 mm	edelstahl-optik	702035-161	20,00
	1-läufig Deckenabstand 48 mm VE = 10 Stück	bronze	-321	22,00
	DECKENTRÄGER 42 mm	edelstahl-optik	702043-161	29,00
	1-läufig Deckenabstand 55 mm VE = 10 Stück	bronze	-321	34,00
	DECKENTRÄGER 500 mm	edelstahl-optik	702050-161	48,00
	1-läufig (kürzbar) Deckenabstand 55-513 mm VE = 10 Stück			

Ø 16 mm Primo

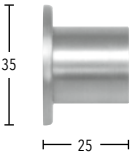
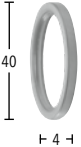
# Ø 16 mm Primo

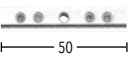
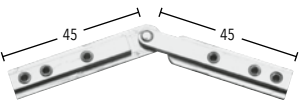
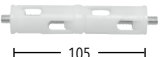
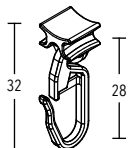
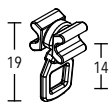
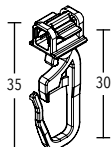
	ARTIKEL	OBERFLÄCHE	ARTIKEL-NR.	EURO / STK.
	WANDLAGER für Ø 16 mm VE = 10 Stück	edelstahl-optik bronze	301640-161 -321	13,00 13,00
	FLACHRING MIT KUNSTSTOFFEINLAGE ohne Faltenleghaken Innen-Ø 34 mm, Außen-Ø 40 mm VE = 100 Stück	edelstahl-optik bronze	202040-161 -321	1,80 1,80
	FALTENLEGHAKEN für Flachringe Art.-Nr. 202040 VE = 100 Stück	weiß silber braun	8186-128 -161 -321	0,10 0,10 0,10
	PROFILVERBINDER VE = 10 Stück	silber	8993-00	10,00
	PROFILVERBINDER verstellbar VE = 10 Stück	silber	89931-00	24,00
	ROHRVERBINDER für Ø 16 mm Rohre VE = 10 Stück	weiß	83016-000	11,00
	GLEITER MIT FALTENLEGHAKEN VE = 100 Stück	weiß grau schwarz	739-00 -08 -57	0,10 0,10 0,10
	GLEITER MIT ÖSE VE = 100 Stück	weiß grau schwarz	740-00 -08 -57	0,10 0,10 0,10
	KLICK-GLEITER MIT FALTENLEGHAKEN VE = 100 Stück	weiß grau schwarz	742-00 -08 -57	0,30 0,30 0,30

Unverbindlich empfohlene Verkaufspreise in EURO inkl. MwSt.

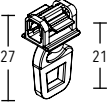
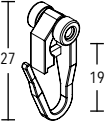
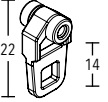
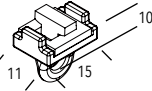
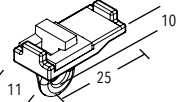
	ARTIKEL	OBERFLÄCHE	ARTIKEL-NR.	EURO / STK.	
	KLICK-GLEITER MIT ÖSE VE = 100 Stück	weiß grau schwarz	743-00 -08 -57	0,30 0,30 0,30	
		ROLLENGLEITER MIT FALTENLEGHAKEN VE = 100 Stück	weiß grau schwarz	741-00 -08 -57	0,25 0,25 0,25
			ROLLENGLEITER MIT ÖSE VE = 100 Stück	weiß grau schwarz	748-00 -08 -57
			FESTSTELLER für Profile VE = 100 Stück	weiß grau schwarz	799-2-00 -08 -57
			FESTSTELLER zur Abdeckung einer Ausklinkung für Profile VE = 100 Stück	weiß grau schwarz	799-4-00 -08 -57

Ø 16 mm Primo

Ø 16 mm Metro

---

edelstahl-optik

Garnitur-Nr. 16-150-161





Ø 16 mm Metro

# Ø 16 mm Metro

## Ringgarnituren 1-läufig, Wandmontage



TAPA - edelstahl-optik - Garnitur-Nr. 16-180-161



KUGEL MIT ROHRAUFNAHME - bronze - Garnitur-Nr. 16-151-321

## Ringgarnituren 2-läufig, Wandmontage

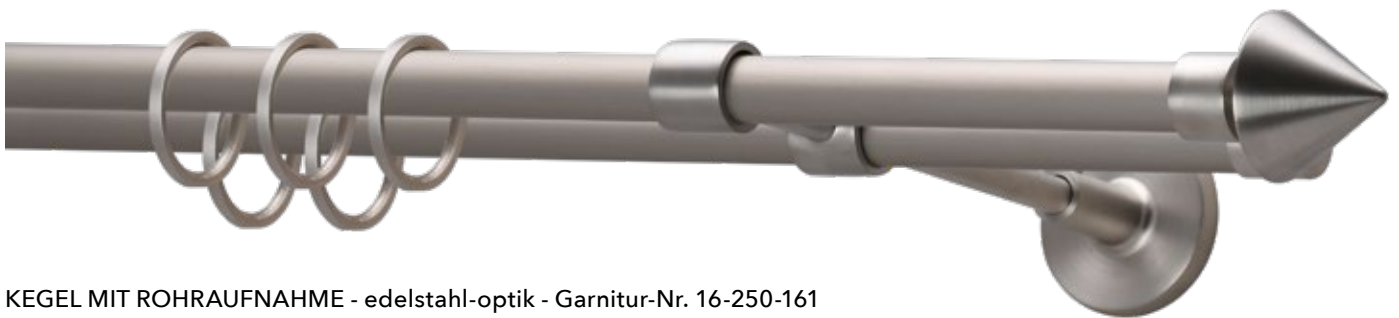

KEGEL MIT ROHRAUFNAHME - edelstahl-optik - Garnitur-Nr. 16-250-161



TAPA - bronze - Garnitur-Nr. 16-280-321

Ringgarnituren 1-läufig, Wandmontage

Länge	Träger	Ringe	Garnitur mit ENDKAPPEN	Garnitur mit ENDSTÜCKEN
100 cm	2	16	112	132
120 cm	2	18	121	141
140 cm	2	20	129	149
160 cm	3	24	163	183
180 cm	3	26	171	191
<hr/>				
200 cm	3	28	179	199
220 cm	3	32	191	211
240 cm	3	34	199	219
260 cm	3	36	207	227
280 cm	3	40	219	239
<hr/>				
300 cm	3	42	227	247
320 cm	4	44	257	277
340 cm	4	46	265	285
360 cm	4	48	273	293
380 cm	4	52	285	305
<hr/>				
400 cm	4	54	293	313
420 cm	4	56	302	322
440 cm	4	60	314	334
460 cm	4	62	322	342
480 cm	5	64	352	372
<hr/>				
500 cm	5	68	364	384
520 cm	5	72	376	396
540 cm	5	74	384	404
560 cm	5	76	392	412
580 cm	5	80	404	424
<hr/>				
Abzug per Wandlager			-17	-27

Auswahl Oberflächen:



Garnitur-Nr. Endkappen

16-180

Tapa



Garnitur-Nr. Endstücke

16-150

Kegel mit Rohraufnahme



16-151

Kugel mit Rohraufnahme



Bestandteile der Garnitur

Rohr

Ø 16 mm



Träger Metro

WA 140 mm



Flachring mit

Faltenleghaken



Ø 16 mm Metro

Ringgarnituren 2-läufig, Wandmontage

Länge	Träger	Ringe	Garnitur mit ENDKAPPEN	Garnitur mit ENDSTÜCKEN
100 cm	2	32	200	220
120 cm	2	36	217	237
140 cm	2	40	233	253
160 cm	3	48	289	309
180 cm	3	52	305	325
<hr/>				
200 cm	3	56	321	341
220 cm	3	64	345	365
240 cm	3	68	361	381
260 cm	3	72	378	398
280 cm	3	80	401	421
<hr/>				
300 cm	3	84	418	438
320 cm	4	88	466	486
340 cm	4	92	482	502
360 cm	4	96	498	518
380 cm	4	104	522	542
<hr/>				
400 cm	4	108	538	558
420 cm	4	112	555	575
440 cm	4	120	579	599
460 cm	4	124	595	615
480 cm	5	128	643	663
<hr/>				
500 cm	5	136	667	687
520 cm	5	144	691	711
540 cm	5	148	707	727
560 cm	5	152	723	743
580 cm	5	160	747	767
<hr/>				
Abzug per Wandlager			-22	-32

Auswahl Oberflächen:

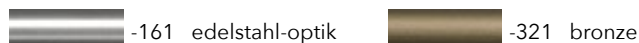

Garnitur-Nr. Endkappen

16-280

Tapa



Garnitur-Nr. Endstücke

16-250

Kegel mit Rohraufnahme



16-251

Kugel mit Rohraufnahme



Bestandteile der Garnitur

Rohr

Ø 16 mm



Träger Metro

WA 140/200 mm







Flachring mit

Faltenleghaken

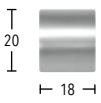
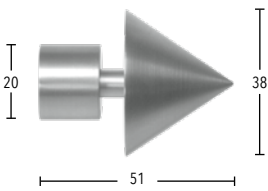
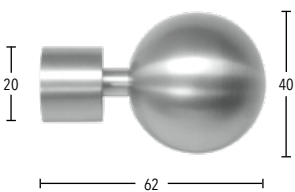
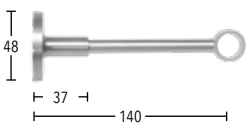
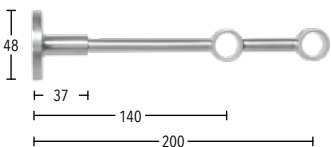
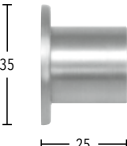

# Ø 16 mm Metro

	ARTIKEL	OBERFLÄCHE	ARTIKEL-NR.	EURO / STK.
	ALUMINIUM-ROHR Ø 16 mm Lagerlänge 6 Meter Preis € per Meter	edelstahl-optik bronze	8016-161 -321	18,00 18,00
	ALUMINIUM-ROHR Ø 16 mm Fixlänge (Zuschnitt) Preis € per Meter	edelstahl-optik bronze	8016-161 -321	21,60 21,60
	Endkappe TAPA für Ø 16 mm VE = 10 Stück	edelstahl-optik bronze	501640-161 -321	8,00 8,00
	Endstück KEGEL MIT ROHRAUFNAHME für Ø 16 mm VE = 10 Stück	edelstahl-optik bronze	501650-161 -321	18,00 18,00
	Endstück KUGEL MIT ROHRAUFNAHME für Ø 16 mm VE = 10 Stück	edelstahl-optik bronze	501651-161 -321	18,00 18,00
	WANDTRÄGER, 1-läufig WA 140 mm (kürzbar) für Ø 16 mm Rohre VE = 10 Stück	edelstahl-optik bronze	601614-161 -321	22,00 22,00
	WANDTRÄGER, 2-läufig WA 140/200 mm (kürzbar) für Ø 16 mm Rohre VE = 10 Stück	edelstahl-optik bronze	601620-161 -321	32,00 32,00
	WANDLAGER für Ø 16 mm VE = 10 Stück	edelstahl-optik bronze	301640-161 -321	13,00 13,00
	FLACHRING MIT KUNSTSTOFFEINLAGE ohne Faltenleghaken Innen-Ø 34 mm, Außen-Ø 40 mm VE = 100 Stück	edelstahl-optik bronze	202040-161 -321	1,80 1,80

Unverbindlich empfohlene Verkaufspreise in EURO inkl. MwSt.

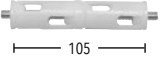

	ARTIKEL	OBERFLÄCHE	ARTIKEL-NR.	EURO / STK.
	FALTENLEGHAKEN	weiß	8186-128	0,10
	für Flachringe Art.-Nr. 202040	silber	-161	0,10
	VE = 100 Stück	braun	-321	0,10
	ROHRVERBINDER	weiß	83016-000	11,00
	für Ø 16 mm Rohre VE = 10 Stück			

Ø 20 mm Primo

---

schwarz

Garnitur-Nr. 20-442-570





Ø 20 mm Primo

# Ø 20 mm Primo

## Ringgarnituren 1-läufig, Wandmontage



KUGEL - schwarz - Garnitur-Nr. 20-142-570



ZYLINDER - gold - Garnitur-Nr. 20-145-091

## Ringgarnituren 2-läufig, Wandmontage



TAPA - weiß - Garnitur-Nr. 20-240-128



DIAGONAL - edelstahl-optik - Garnitur-Nr. 20-244-161

Ringgarnituren 1-läufig, Wandmontage

Länge	Träger	Ringe	Garnitur mit ENDKAPPEN	Garnitur mit ENDSTÜCKEN
100 cm	2	16	117	129
120 cm	2	18	125	137
140 cm	2	20	134	146
160 cm	2	24	146	158
180 cm	3	26	177	189
<hr/>				
200 cm	3	28	186	198
220 cm	3	32	198	210
240 cm	3	34	207	219
260 cm	3	36	215	227
280 cm	3	40	228	240
<hr/>				
300 cm	3	42	236	248
320 cm	3	44	245	257
340 cm	3	46	253	265
360 cm	4	48	284	296
380 cm	4	52	296	308
<hr/>				
400 cm	4	54	305	317
420 cm	4	56	314	326
440 cm	4	60	326	338
460 cm	4	62	335	347
480 cm	4	64	343	355
<hr/>				
500 cm	4	68	356	368
520 cm	4	72	368	380
540 cm	5	74	399	411
560 cm	5	76	407	419
580 cm	5	80	420	432
<hr/>				
Abzug per Wandlager			-17	-23

Auswahl Oberflächen:

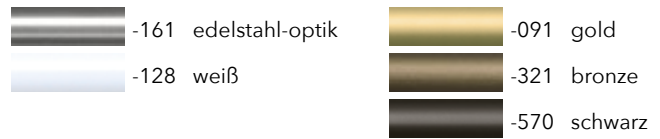

Garnitur-Nr. Endkappen

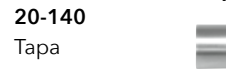

Bestandteile der Garnitur

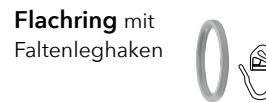

Garnitur-Nr. Endstücke

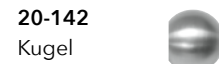

Ø 20 mm Primo

\* nicht in -570 schwarz verfügbar

Ringgarnituren 2-läufig, Wandmontage

Länge	Träger	Ringe	Garnitur mit ENDKAPPEN	Garnitur mit ENDSTÜCKEN
100 cm	2	32	209	221
120 cm	2	36	226	238
140 cm	2	40	244	256
160 cm	2	48	268	280
180 cm	3	52	318	330
<hr/>				
200 cm	3	56	335	347
220 cm	3	64	360	372
240 cm	3	68	377	389
260 cm	3	72	394	406
280 cm	3	80	419	431
<hr/>				
300 cm	3	84	436	448
320 cm	3	88	453	465
340 cm	3	92	470	482
360 cm	4	96	520	532
380 cm	4	104	544	556
<hr/>				
400 cm	4	108	562	574
420 cm	4	112	579	591
440 cm	4	120	604	616
460 cm	4	124	621	633
480 cm	4	128	638	650
<hr/>				
500 cm	4	136	663	675
520 cm	4	144	688	700
540 cm	5	148	737	749
560 cm	5	152	754	766
580 cm	5	160	779	791
<hr/>				
Abzug per Wandlager			-22	-28

Auswahl Oberflächen:

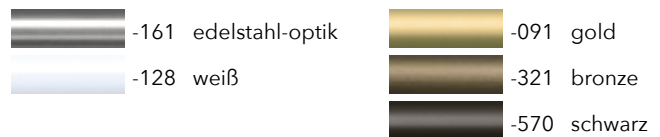

Garnitur-Nr. Endkappen

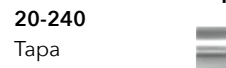

Bestandteile der Garnitur

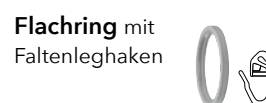

Garnitur-Nr. Endstücke

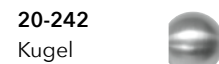
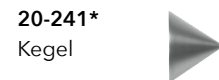

\* nicht in -570 schwarz verfügbar

Bestellangaben: Garnitur-Nr., Farbcode, Länge · Unverbindlich empfohlene Verkaufspreise in EURO inkl. MwSt.

# Ø 20 mm Primo

## Profilgarnituren 1-läufig, Wandmontage



ELLIPSE - bronze - Garnitur-Nr. 20-443-321

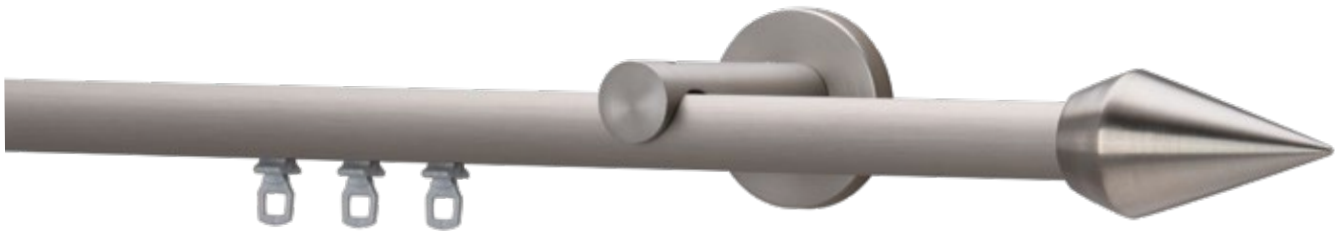

SPITZE - edelstahl-optik - Garnitur-Nr. 20-446-161

## Profilgarnituren 2-läufig, Wandmontage



TAPA - schwarz - Garnitur-Nr. 20-540-570







KEGEL - gold - Garnitur-Nr. 20-541-091

Profilgarnituren 1-läufig, Wandmontage

Länge	Träger	Gleiter	Garnitur mit ENDKAPPEN	Garnitur mit ENDSTÜCKEN
100 cm	2	16	99	111
120 cm	2	18	106	118
140 cm	2	20	113	125
160 cm	2	24	120	132
180 cm	3	26	149	161
<hr/>				
200 cm	3	28	155	167
220 cm	3	32	163	175
240 cm	3	34	170	182
260 cm	3	36	176	188
280 cm	3	40	184	196
<hr/>				
300 cm	3	42	190	202
320 cm	3	44	197	209
340 cm	3	46	204	216
360 cm	4	48	233	245
380 cm	4	52	240	252
<hr/>				
400 cm	4	54	247	259
420 cm	4	56	254	266
440 cm	4	60	261	273
460 cm	4	62	268	280
480 cm	4	64	275	287
<hr/>				
500 cm	4	68	282	294
520 cm	4	72	289	301
540 cm	5	74	318	330
560 cm	5	76	325	337
580 cm	5	80	332	344
<hr/>				
Abzug per Wandlager			-17	-23

Auswahl Oberflächen:

	-161 edelstahl-optik		-091 gold
	-128 weiß		-321 bronze
			-570 schwarz

Garnitur-Nr. Endkappen

20-440  
Tapa 

Garnitur-Nr. Endstücke

20-441\*  
Kegel 

Bestandteile der Garnitur

Profil  
Ø 20 mm 

20-442  
Kugel 

20-443\*  
Ellipse 

Träger Primo

WA 65 mm 

20-444\*  
Diagonal 

Gleiter  
Art.-Nr. 739 

20-445\*  
Zylinder 

20-446\*  
Spitze 





Ø 20 mm Primo

\* nicht in -570 schwarz verfügbar

Profilgarnituren 2-läufig, Wandmontage

Länge	Träger	Gleiter	Garnitur mit ENDKAPPEN	Garnitur mit ENDSTÜCKEN
100 cm	2	32	173	185
120 cm	2	36	187	199
140 cm	2	40	201	213
160 cm	2	48	215	227
180 cm	3	52	261	273
<hr/>				
200 cm	3	56	274	286
220 cm	3	64	289	301
240 cm	3	68	303	315
260 cm	3	72	316	328
280 cm	3	80	331	343
<hr/>				
300 cm	3	84	344	356
320 cm	3	88	358	370
340 cm	3	92	372	384
360 cm	4	96	418	430
380 cm	4	104	432	444
<hr/>				
400 cm	4	108	446	458
420 cm	4	112	460	472
440 cm	4	120	474	486
460 cm	4	124	488	500
480 cm	4	128	502	514
<hr/>				
500 cm	4	136	516	528
520 cm	4	144	530	542
540 cm	5	148	576	588
560 cm	5	152	590	602
580 cm	5	160	604	616
<hr/>				
Abzug per Wandlager			-22	-28

Auswahl Oberflächen:

	-161 edelstahl-optik		-091 gold
	-128 weiß		-321 bronze
			-570 schwarz

Garnitur-Nr. Endkappen

20-540  
Tapa 

Garnitur-Nr. Endstücke

20-541\*  
Kegel 

Bestandteile der Garnitur

Profil  
Ø 20 mm 

20-542  
Kugel 

20-543\*  
Ellipse 

Träger Primo

WA 65/120 mm 

20-544\*  
Diagonal 

Gleiter  
Art.-Nr. 739 

20-545\*  
Zylinder 

20-546\*  
Spitze 

Bestellangaben: Garnitur-Nr., Farbcode, Länge · Unverbindlich empfohlene Verkaufspreise in EURO inkl. MwSt.

\* nicht in -570 schwarz verfügbar

Standardgleiter (Art.-Nr. 739-xx)  alternativ Gleiter mit Öse (Art.-Nr. 740-xx)  ohne Aufpreis.

# Ø 20 mm Primo

## Kombigarnituren 2-läufig, Wandmontage



KUGEL - edelstahl-optik - Garnitur-Nr. 20-342-161

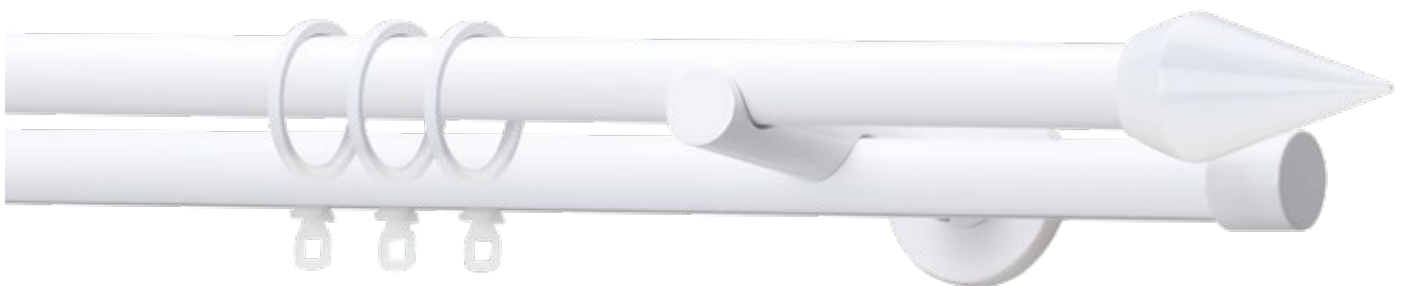

SPITZE - weiß - Garnitur-Nr. 20-346-128

## Profilgarnituren 1-läufig, Deckenmontage



TAPA - gold - Garnitur-Nr. 20-640-091



TAPA - bronze - Garnitur-Nr. 20-640-321



Kombigarnituren 2-läufig, Wandmontage

Länge	Träger	Ringe/ Gleiter	Garnitur mit ENDKAPPEN	Garnitur mit ENDSTÜCKEN
100 cm	2	16	191	203
120 cm	2	18	207	219
140 cm	2	20	222	234
160 cm	2	24	242	254
180 cm	3	26	289	301
<hr/>				
200 cm	3	28	305	317
220 cm	3	32	324	336
240 cm	3	34	340	352
260 cm	3	36	355	367
280 cm	3	40	375	387
<hr/>				
300 cm	3	42	390	402
320 cm	3	44	406	418
340 cm	3	46	421	433
360 cm	4	48	469	481
380 cm	4	52	488	500
<hr/>				
400 cm	4	54	504	516
420 cm	4	56	519	531
440 cm	4	60	539	551
460 cm	4	62	554	566
480 cm	4	64	570	582
<hr/>				
500 cm	4	68	589	601
520 cm	4	72	609	621
540 cm	5	74	657	669
560 cm	5	76	672	684
580 cm	5	80	692	704
Abzug per Wandlager			-22	-28

Auswahl Oberflächen:

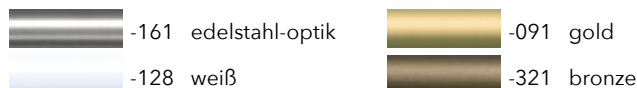

Garnitur-Nr. Endkappen



Bestandteile der Garnitur



Träger Primo

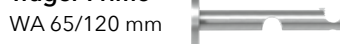

Flachring mit

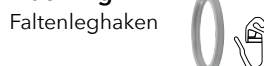

Gleiter

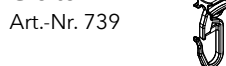

Garnitur-Nr. Endstücke

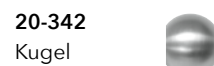
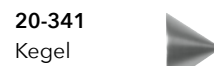

Ø 20 mm Primo

Profilgarnituren 1-läufig, Deckenmontage

Länge	Träger	Gleiter	Garnitur mit ENDKAPPEN
100 cm	2	16	71
120 cm	2	18	78
140 cm	2	20	85
160 cm	2	24	92
180 cm	3	26	107
<hr/>			
200 cm	3	28	113
220 cm	3	32	121
240 cm	3	34	128
260 cm	3	36	134
280 cm	3	40	142
<hr/>			
300 cm	3	42	148
320 cm	3	44	155
340 cm	3	46	162
360 cm	4	48	177
380 cm	4	52	184
<hr/>			
400 cm	4	54	191
420 cm	4	56	198
440 cm	4	60	205
460 cm	4	62	212
480 cm	4	64	219
<hr/>			
500 cm	4	68	226
520 cm	4	72	233
540 cm	5	74	248
560 cm	5	76	255
580 cm	5	80	262
Abzug per Wandlager			-3

Auswahl Oberflächen:

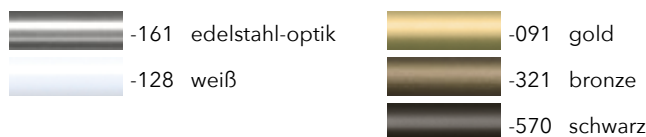

Garnitur-Nr. Endkappen



Bestandteile der Garnitur

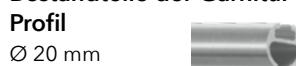

Deckenträger

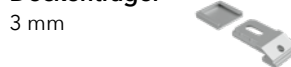

Gleiter

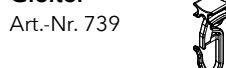

Bestellangaben: Garnitur-Nr., Farbcode, Länge · Unverbindlich empfohlene Verkaufspreise in EURO inkl. MwSt.

Standardgleiter (Art.-Nr. 739-xx) alternativ Gleiter mit Öse (Art.-Nr. 740-xx) ohne Aufpreis.

# Ø 20 mm Primo

Profilgarnituren 1-läufig, Deckenmontage



KUGEL - schwarz - Garnitur-Nr. 20-742-570



KEGEL - edelstahl-optik - Garnitur-Nr. 20-741-161

Profilgarnituren 1-läufig, Deckenmontage



DIAGONAL - gold - Garnitur-Nr. 20-844-091



ZYLINDER - weiß - Garnitur-Nr. 20-845-128

Profilgarnituren 1-läufig, Deckenmontage

Länge	Träger	Gleiter	Garnitur mit ENDKAPPEN	Garnitur mit ENDSTÜCKEN
100 cm	2	16	95	107
120 cm	2	18	102	114
140 cm	2	20	109	121
160 cm	2	24	116	128
180 cm	3	26	143	155
<hr/>				
200 cm	3	28	149	161
220 cm	3	32	157	169
240 cm	3	34	164	176
260 cm	3	36	170	182
280 cm	3	40	178	190
<hr/>				
300 cm	3	42	184	196
320 cm	3	44	191	203
340 cm	3	46	198	210
360 cm	4	48	225	237
380 cm	4	52	232	244
<hr/>				
400 cm	4	54	239	251
420 cm	4	56	246	258
440 cm	4	60	253	265
460 cm	4	62	260	272
480 cm	4	64	267	279
<hr/>				
500 cm	4	68	274	286
520 cm	4	72	281	293
540 cm	5	74	308	320
560 cm	5	76	315	327
580 cm	5	80	322	334
<hr/>				
Abzug per Wandlager			-15	-21

Auswahl Oberflächen:

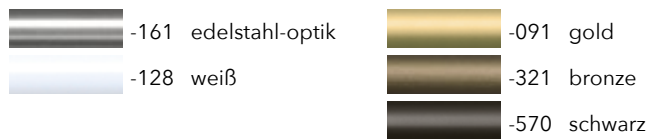

Garnitur-Nr. Endkappen



Garnitur-Nr. Endstücke

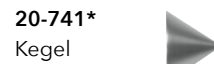

Bestandteile der Garnitur

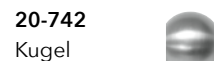

Deckenträger



Gleiter

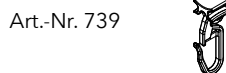

Ø 20 mm Primo

\* nicht in -570 schwarz verfügbar

Profilgarnituren 1-läufig, Deckenmontage

Länge	Träger	Gleiter	Garnitur mit ENDKAPPEN	Garnitur mit ENDSTÜCKEN
100 cm	2	16	99	111
120 cm	2	18	106	118
140 cm	2	20	113	125
160 cm	2	24	120	132
180 cm	3	26	149	161
<hr/>				
200 cm	3	28	155	167
220 cm	3	32	163	175
240 cm	3	34	170	182
260 cm	3	36	176	188
280 cm	3	40	184	196
<hr/>				
300 cm	3	42	190	202
320 cm	3	44	197	209
340 cm	3	46	204	216
360 cm	4	48	233	245
380 cm	4	52	240	252
<hr/>				
400 cm	4	54	247	259
420 cm	4	56	254	266
440 cm	4	60	261	273
460 cm	4	62	268	280
480 cm	4	64	275	287
<hr/>				
500 cm	4	68	282	294
520 cm	4	72	289	301
540 cm	5	74	318	330
560 cm	5	76	325	337
580 cm	5	80	332	344
<hr/>				
Abzug per Wandlager			-17	-23

Auswahl Oberflächen:

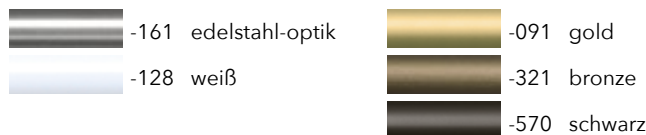

Garnitur-Nr. Endkappen



Garnitur-Nr. Endstücke

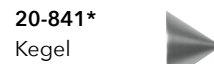

Bestandteile der Garnitur

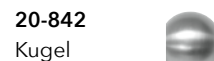

Deckenträger



Gleiter

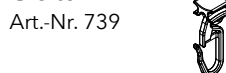





Bestellangaben: Garnitur-Nr., Farbcode, Länge · Unverbindlich empfohlene Verkaufspreise in EURO inkl. MwSt.



\* nicht in -570 schwarz verfügbar

Standardgleiter (Art.-Nr. 739-xx) alternativ Gleiter mit Öse (Art.-Nr. 740-xx) ohne Aufpreis.

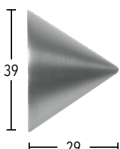
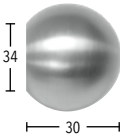
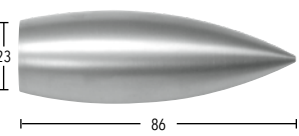
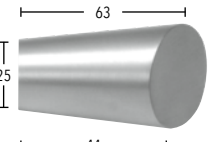
# Ø 20 mm Primo

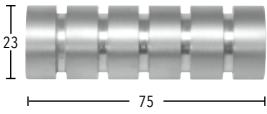
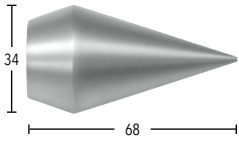
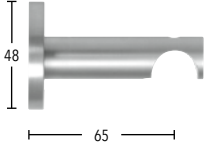
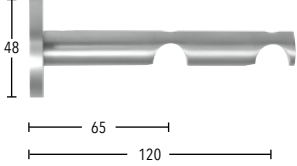
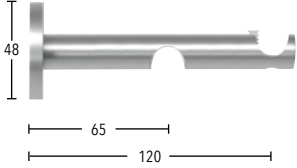
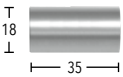
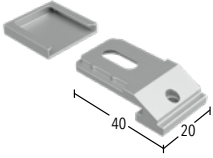

	ARTIKEL	OBERFLÄCHE	ARTIKEL-NR.	EURO / STK.
	ALUMINIUM-ROHR Ø 20 mm	edelstahl-optik	8020-161	20,00
	Lagerlänge 6 Meter	weiß	-128	20,00
	Preis € per Meter	gold	-091	20,00
		bronze	-321	20,00
		schwarz	-570	20,00
	ALUMINIUM-ROHR Ø 20 mm	edelstahl-optik	8020-161	24,00
	Fixlänge (Zuschnitt)	weiß	-128	24,00
	Preis € per Meter	gold	-091	24,00
		bronze	-321	24,00
		schwarz	-570	24,00
	ALUMINIUM-PROFIL Ø 20 mm	edelstahl-optik	8820-161	28,00
	Lagerlänge 6 Meter	weiß	-128	28,00
	Preis € per Meter	gold	-091	28,00
		bronze	-321	28,00
		schwarz	-570	28,00
	ALUMINIUM-PROFIL Ø 20 mm	edelstahl-optik	8820-161	33,60
	Fixlänge (Zuschnitt)	weiß	-128	33,60
	Preis € per Meter	gold	-091	33,60
		bronze	-321	33,60
		schwarz	-570	33,60
	Endkappe	edelstahl-optik	502040-161	9,00
	TAPA	weiß	-128	9,00
	für Ø 20 mm	gold	-091	9,00
	VE = 10 Stück	bronze	-321	9,00
		schwarz	-570	9,00
	Endstück	edelstahl-optik	502041-161	15,00
	KEGEL	weiß	-128	15,00
	für Ø 20 mm	gold	-091	15,00
	VE = 10 Stück	bronze	-321	15,00
	Endstück	edelstahl-optik	502042-161	15,00
	KUGEL	weiß	-128	15,00
	für Ø 20 mm	gold	-091	15,00
	VE = 10 Stück	bronze	-321	15,00
	schwarz	-570	15,00	
	Endstück	edelstahl-optik	502043-161	15,00
	ELLIPSE	weiß	-128	15,00
	für Ø 20 mm	gold	-091	15,00
	VE = 10 Stück	bronze	-321	15,00
	Endstück	edelstahl-optik	502044-161	15,00
	DIAGONAL	weiß	-128	15,00
	für Ø 20 mm	gold	-091	15,00
	bronze	-321	15,00	

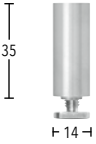
Unverbindlich empfohlene Verkaufspreise in EURO inkl. MwSt.

	ARTIKEL	OBERFLÄCHE	ARTIKEL-NR.	EURO / STK.
	Endstück	edelstahl-optik	502045-161	15,00
	ZYLINDER	weiß	-128	15,00
	für Ø 20 mm	gold	-091	15,00
	VE = 10 Stück	bronze	-321	15,00
	Endstück	edelstahl-optik	502046-161	15,00
	SPITZE	weiß	-128	15,00
	für Ø 20 mm	gold	-091	15,00
	VE = 10 Stück	bronze	-321	15,00
	WANDTRÄGER, 1-läufig	edelstahl-optik	602065-161	22,00
	WA 65 mm	weiß	-128	22,00
	für Ø 20 mm Rohre und Profile	gold	-091	22,00
	VE = 10 Stück	bronze	-321	22,00
	<b>Auch mit WA 120 mm erhältlich: Art.-Nr. 602120- UVP: 30,00 €</b>	schwarz	-570	22,00
	WANDTRÄGER, 2-läufig	edelstahl-optik	602012-161	32,00
	WA 65/120 mm	weiß	-128	32,00
	für Ø 20 mm Rohre und Profile	gold	-091	32,00
	VE = 10 Stück	bronze	-321	32,00
		schwarz	-570	32,00
	KOMBI-WANDTRÄGER, 2-läufig	edelstahl-optik	602022-161	32,00
	WA 65/120 mm	weiß	-128	32,00
	für Ø 20 mm Rohre/Profile	gold	-091	32,00
	VE = 10 Stück	bronze	-321	32,00
	TRÄGERVERLÄNGERUNG	edelstahl-optik	402035-161	14,00
	Länge 35 mm	weiß	-128	14,00
	VE = 10 Stück	gold	-091	14,00
		bronze	-321	14,00
		schwarz	-570	14,00
	DECKENTRÄGER 3 mm	weiß	702013-128	8,00
	1-läufig	grau	-161	8,00
	Deckenabstand 21 mm	schwarz	-570	8,00
	VE = 10 Stück			
	DECKENTRÄGER 15 mm	edelstahl-optik	702015-161	18,00
	1-läufig	weiß	-128	18,00
	Deckenabstand 33 mm	gold	-091	20,00
	VE = 10 Stück	bronze	-321	20,00
		schwarz	-570	18,00
	DECKENTRÄGER 35 mm	edelstahl-optik	702035-161	20,00
	1-läufig	weiß	-128	20,00
	Deckenabstand 53 mm	gold	-091	22,00
	VE = 10 Stück	bronze	-321	22,00
		schwarz	-570	20,00

Ø 20 mm Primo

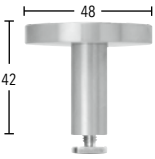
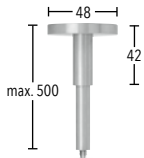
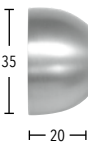
# Ø 20 mm Primo

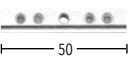
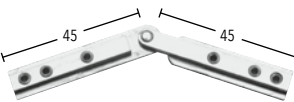
	ARTIKEL	OBERFLÄCHE	ARTIKEL-NR.	EURO / STK.
	DECKENTRÄGER 42 mm	edelstahl-optik	702043-161	29,00
	1-läufig	weiß	-128	29,00
	Deckenabstand 60 mm	gold	-091	34,00
	VE = 10 Stück	bronze	-321	34,00
		schwarz	-570	29,00
	DECKENTRÄGER 500 mm	edelstahl-optik	702050-161	48,00
	1-läufig (kürzbar)	weiß	-128	48,00
	Deckenabstand 60-518 mm	gold	-091	54,00
	VE = 10 Stück	schwarz	-570	48,00
	WANDLAGER	edelstahl-optik	302040-161	14,00
	für Ø 20 mm	weiß	-128	14,00
	VE = 10 Stück	gold	-091	14,00
		bronze	-321	14,00
		schwarz	-570	14,00
	FLACHRING MIT KUNSTSTOFFEINLAGE	edelstahl-optik	202040-161	1,80
	ohne Faltenleghaken	weiß	-128	1,80
	Innen-Ø 34 mm, Außen-Ø 40 mm	gold	-091	1,80
	VE = 100 Stück	bronze	-321	1,80
		schwarz	-570	1,80
	FALTENLEGHAKEN	weiß	8186-128	0,10
	für Flachringe Art.-Nr. 202040	silber	-161	0,10
	VE = 100 Stück	gold	-091	0,10
		braun	-321	0,10
		schwarz	-570	0,10
	PROFILVERBINDER	silber	8993-00	10,00
	VE = 10 Stück			
	PROFILVERBINDER verstellbar	silber	89931-00	24,00
	VE = 10 Stück			
	ROHRVERBINDER	weiß	83020-000	12,00
	für Ø 20 mm Rohre VE = 10 Stück			
	GLEITER MIT FALTENLEGHAKEN	weiß	739-00	0,10
	VE = 100 Stück	grau	-08	0,10
		schwarz	-57	0,10

Unverbindlich empfohlene Verkaufspreise in EURO inkl. MwSt.

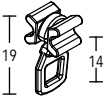
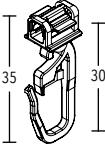
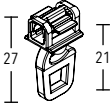
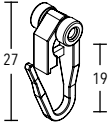
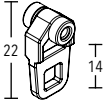
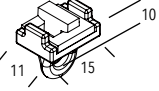
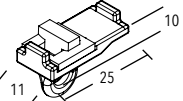
	ARTIKEL	OBERFLÄCHE	ARTIKEL-NR.	EURO / STK.	
	GLEITER MIT ÖSE VE = 100 Stück	weiß grau schwarz	740-00 -08 -57	0,10 0,10 0,10	
		KLICK-GLEITER MIT FALTENLEGHAKEN VE = 100 Stück	weiß grau schwarz	742-00 -08 -57	0,30 0,30 0,30
			KLICK-GLEITER MIT ÖSE VE = 100 Stück	weiß grau schwarz	743-00 -08 -57
			ROLLENGLEITER MIT FALTENLEGHAKEN VE = 100 Stück	weiß grau schwarz	741-00 -08 -57
			ROLLENGLEITER MIT ÖSE VE = 100 Stück	weiß grau schwarz	748-00 -08 -57
			FESTSTELLER für Profile VE = 100 Stück	weiß grau schwarz	799-2-00 -08 -57
			FESTSTELLER zur Abdeckung einer Ausklindung für Profile VE = 100 Stück	weiß grau schwarz	799-4-00 -08 -57

Ø 20 mm Primo

Ø 20 mm Metro

---

edelstahl-optik

Garnitur-Nr. 20-151-161







Ø 20 mm Metro

# Ø 20 mm Metro

## Ringgarnituren 1-läufig, Wandmontage



KEGEL MIT ROHRAUFNAHME - edelstahl-optik - Garnitur-Nr. 20-150-161

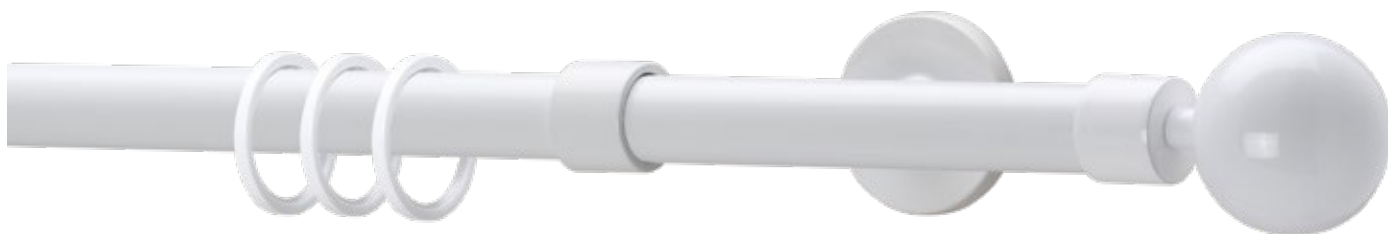

KUGEL MIT ROHRAUFNAHME - weiß - Garnitur-Nr. 20-151-128

## Ringgarnituren 2-läufig, Wandmontage

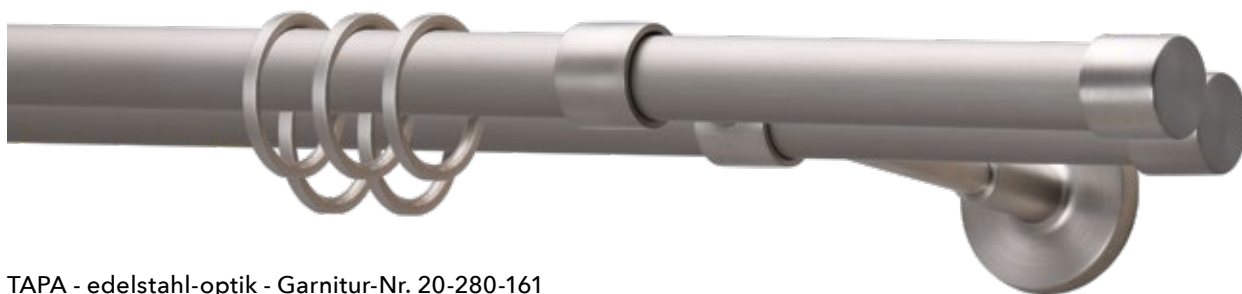

TAPA - edelstahl-optik - Garnitur-Nr. 20-280-161



KEGEL MIT ROHRAUFNAHME - weiß - Garnitur-Nr. 20-250-128

Ringgarnituren 1-läufig, Wandmontage

Länge	Träger	Ringe	Garnitur mit ENDKAPPEN	Garnitur mit ENDSTÜCKEN
100 cm	2	16	117	139
120 cm	2	18	125	147
140 cm	2	20	134	156
160 cm	2	24	146	168
180 cm	3	26	177	199
<hr/>				
200 cm	3	28	186	208
220 cm	3	32	198	220
240 cm	3	34	207	229
260 cm	3	36	215	237
280 cm	3	40	228	250
<hr/>				
300 cm	3	42	236	258
320 cm	3	44	245	267
340 cm	3	46	253	275
360 cm	4	48	284	306
380 cm	4	52	296	318
<hr/>				
400 cm	4	54	305	327
420 cm	4	56	314	336
440 cm	4	60	326	348
460 cm	4	62	335	357
480 cm	4	64	343	365
<hr/>				
500 cm	4	68	356	378
520 cm	4	72	368	390
540 cm	5	74	399	421
560 cm	5	76	407	429
580 cm	5	80	420	442
<hr/>				
Abzug per Wandlager			-17	-28

Auswahl Oberflächen:

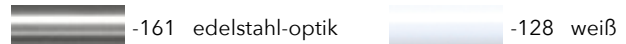

Garnitur-Nr. Endkappen

20-180

Tapa



Garnitur-Nr. Endstücke

20-150

Kegel mit Rohraufnahme



20-151

Kugel mit Rohraufnahme



Bestandteile der Garnitur

Rohr

Ø 20 mm



Träger Metro

WA 140 mm



Flachring mit

Faltenleghaken



Ringgarnituren 2-läufig, Wandmontage

Länge	Träger	Ringe	Garnitur mit ENDKAPPEN	Garnitur mit ENDSTÜCKEN
100 cm	2	32	209	231
120 cm	2	36	226	248
140 cm	2	40	244	266
160 cm	2	48	268	290
180 cm	3	52	318	340
<hr/>				
200 cm	3	56	335	357
220 cm	3	64	360	382
240 cm	3	68	377	399
260 cm	3	72	394	416
280 cm	3	80	419	441
<hr/>				
300 cm	3	84	436	458
320 cm	3	88	453	475
340 cm	3	92	470	492
360 cm	4	96	520	542
380 cm	4	104	544	566
<hr/>				
400 cm	4	108	562	584
420 cm	4	112	579	601
440 cm	4	120	604	626
460 cm	4	124	621	643
480 cm	4	128	638	660
<hr/>				
500 cm	4	136	663	685
520 cm	4	144	688	710
540 cm	5	148	737	759
560 cm	5	152	754	776
580 cm	5	160	779	801
<hr/>				
Abzug per Wandlager			-22	-33

Auswahl Oberflächen:



Garnitur-Nr. Endkappen

20-280

Tapa



Garnitur-Nr. Endstücke

20-250

Kegel mit Rohraufnahme



20-251

Kugel mit Rohraufnahme



Bestandteile der Garnitur

Rohr

Ø 20 mm



Träger Metro

WA 140/200 mm







Flachring mit

Faltenleghaken

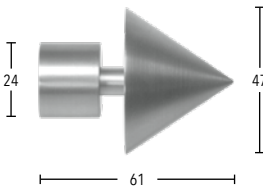
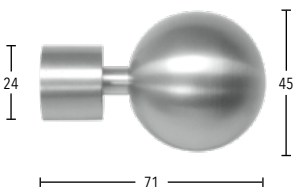
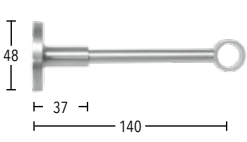
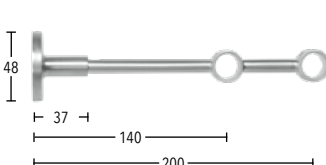
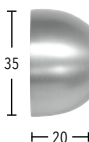

# Ø 20 mm Metro

	ARTIKEL	OBERFLÄCHE	ARTIKEL-NR.	EURO / STK.
	ALUMINIUM-ROHR Ø 20 mm Lagerlänge 6 Meter Preis € per Meter	edelstahl-optik weiß	8020-161 -128	20,00 20,00
	ALUMINIUM-ROHR Ø 20 mm Fixlänge (Zuschnitt) Preis € per Meter	edelstahl-optik weiß	8020-161 -128	24,00 24,00
	Endkappe TAPA für Ø 20 mm VE = 10 Stück	edelstahl-optik weiß	502040-161 -128	9,00 9,00
	Endstück KEGEL MIT ROHRAUFNAHME für Ø 20 mm VE = 10 Stück	edelstahl-optik weiß	502050-161 -128	20,00 20,00
	Endstück KUGEL MIT ROHRAUFNAHME für Ø 20 mm VE = 10 Stück	edelstahl-optik weiß	502051-161 -128	20,00 20,00
	WANDTRÄGER, 1-läufig WA 140 mm (kürzbar) für Ø 20 mm Rohre VE = 10 Stück	edelstahl-optik weiß	602014-161 -128	22,00 22,00
	WANDTRÄGER, 2-läufig WA 140/200 mm (kürzbar) für Ø 20 mm Rohre VE = 10 Stück	edelstahl-optik weiß	602020-161 -128	32,00 32,00
	WANDLAGER für Ø 20 mm VE = 10 Stück	edelstahl-optik weiß	302040-161 -128	14,00 14,00
	FLACHRING MIT KUNSTSTOFFEINLAGE ohne Faltenleghaken Innen-Ø 34 mm, Außen-Ø 40 mm VE = 100 Stück	edelstahl-optik weiß	202040-161 -128	1,80 1,80

Unverbindlich empfohlene Verkaufspreise in EURO inkl. MwSt.

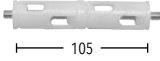
	ARTIKEL	OBERFLÄCHE	ARTIKEL-NR.	EURO / STK.
	FALTENLEGHAKEN	weiß	8186-128	0,10
	für Flachringe Art.-Nr. 202040 VE = 100 Stück	silber	-161	0,10
	ROHRVERBINDER	weiß	83020-000	12,00
	für Ø 20 mm Rohre VE = 10 Stück			

Ø 20 mm Quad

---

weiß

Garnitur-Nr. 20-471-128

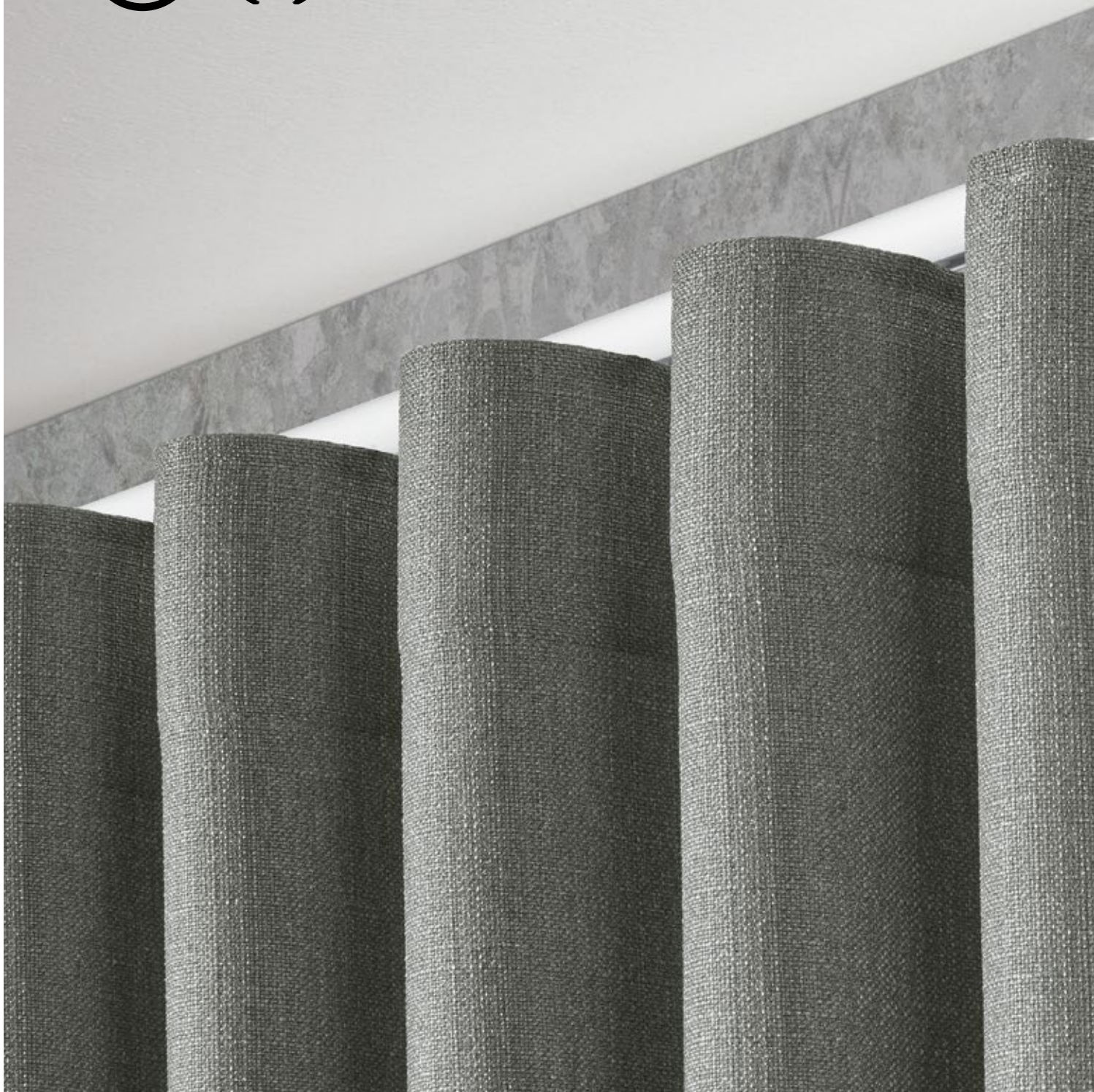



Ø 20 mm Quad

# Ø 20 mm Quad

## Ringgarnituren 1-läufig, Wandmontage



ZYLINDER, eckig - edelstahl-optik - Garnitur-Nr. 20-171-161



TAPA, eckig - gold - Garnitur-Nr. 20-170-091

## Ringgarnituren 2-läufig, Wandmontage



ZYLINDER, rund - weiß - Garnitur-Nr. 20-272-128



ZYLINDER, eckig - bronze - Garnitur-Nr. 20-271-321



Ringgarnituren 1-läufig, Wandmontage

Länge	Träger	Ringe	Garnitur mit ENDKAPPEN	Garnitur mit ENDSTÜCKEN
100 cm	2	16	145	159
120 cm	2	18	153	167
140 cm	2	20	162	176
160 cm	2	24	174	188
180 cm	3	26	217	231
<hr/>				
200 cm	3	28	226	240
220 cm	3	32	238	252
240 cm	3	34	247	261
260 cm	3	36	255	269
280 cm	3	40	268	282
<hr/>				
300 cm	3	42	276	290
320 cm	3	44	285	299
340 cm	3	46	293	307
360 cm	4	48	336	350
380 cm	4	52	348	362
<hr/>				
400 cm	4	54	357	371
420 cm	4	56	366	380
440 cm	4	60	378	392
460 cm	4	62	387	401
480 cm	4	64	395	409
<hr/>				
500 cm	4	68	408	422
520 cm	4	72	420	434
540 cm	5	74	463	477
560 cm	5	76	471	485
580 cm	5	80	484	498
<hr/>				
Abzug per Wandlager			-31	-38

Auswahl Oberflächen:

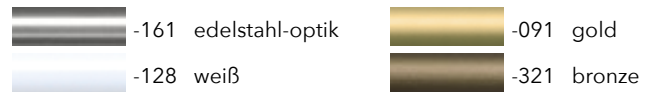

Garnitur-Nr. Endkappen

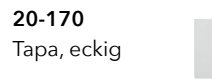

Garnitur-Nr. Endstücke



Bestandteile der Garnitur

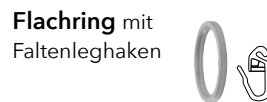

Ringgarnituren 2-läufig, Wandmontage

Länge	Träger	Ringe	Garnitur mit ENDKAPPEN	Garnitur mit ENDSTÜCKEN
100 cm	2	32	233	247
120 cm	2	36	250	264
140 cm	2	40	268	282
160 cm	2	48	292	306
180 cm	3	52	350	364
<hr/>				
200 cm	3	56	367	381
220 cm	3	64	392	406
240 cm	3	68	409	423
260 cm	3	72	426	440
280 cm	3	80	451	465
<hr/>				
300 cm	3	84	468	482
320 cm	3	88	485	499
340 cm	3	92	502	516
360 cm	4	96	560	574
380 cm	4	104	584	598
<hr/>				
400 cm	4	108	602	616
420 cm	4	112	619	633
440 cm	4	120	644	658
460 cm	4	124	661	675
480 cm	4	128	678	692
<hr/>				
500 cm	4	136	703	717
520 cm	4	144	728	742
540 cm	5	148	785	799
560 cm	5	152	802	816
580 cm	5	160	827	841
<hr/>				
Abzug per Wandlager			-34	-41

Auswahl Oberflächen:

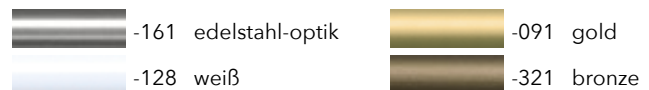

Garnitur-Nr. Endkappen

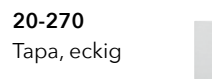

Garnitur-Nr. Endstücke



Bestandteile der Garnitur

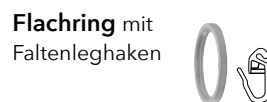

Ø 20 mm Quad

# Ø 20 mm Quad

## Profilgarnituren 1-läufig, Wandmontage



TAPA, eckig - weiß - Garnitur-Nr. 20-470-128



ZYLINDER, rund - edelstahl-optik - Garnitur-Nr. 20-472-161

## Profilgarnituren 2-läufig, Wandmontage



TAPA, eckig - bronze - Garnitur-Nr. 20-570-321

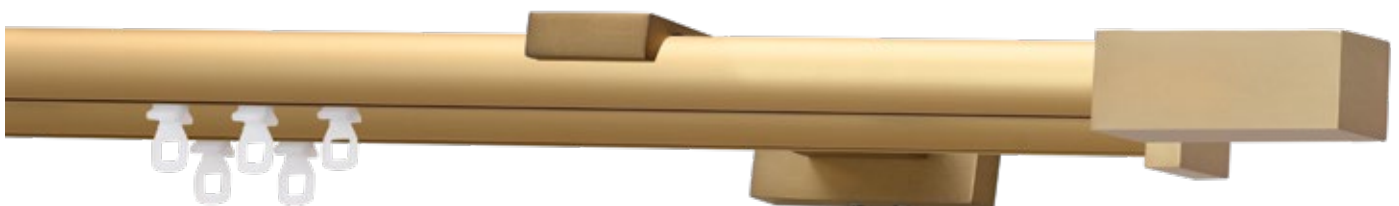

ZYLINDER, eckig - gold - Garnitur-Nr. 20-571-091

Profilgarnituren 1-läufig, Wandmontage

Länge	Träger	Gleiter	Garnitur mit ENDKAPPEN	Garnitur mit ENDSTÜCKEN
100 cm	2	16	127	141
120 cm	2	18	134	148
140 cm	2	20	141	155
160 cm	2	24	148	162
180 cm	3	26	189	203
<hr/>				
200 cm	3	28	195	209
220 cm	3	32	203	217
240 cm	3	34	210	224
260 cm	3	36	216	230
280 cm	3	40	224	238
<hr/>				
300 cm	3	42	230	244
320 cm	3	44	237	251
340 cm	3	46	244	258
360 cm	4	48	285	299
380 cm	4	52	292	306
<hr/>				
400 cm	4	54	299	313
420 cm	4	56	306	320
440 cm	4	60	313	327
460 cm	4	62	320	334
480 cm	4	64	327	341
<hr/>				
500 cm	4	68	334	348
520 cm	4	72	341	355
540 cm	5	74	382	396
560 cm	5	76	389	403
580 cm	5	80	396	410
<hr/>				
Abzug per Wandlager			-31	-38

Auswahl Oberflächen:

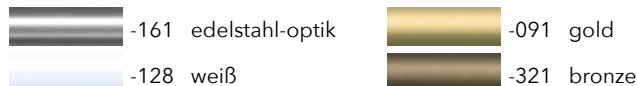

Garnitur-Nr. Endkappen

20-470

Tapa, eckig



Garnitur-Nr. Endstücke

20-471

Zylinder, eckig



20-472

Zylinder, rund



Bestandteile der Garnitur

Profil

Ø 20 mm



Träger Quad

WA 80 mm



Gleiter

Art.-Nr. 739



Profilgarnituren 2-läufig, Wandmontage

Länge	Träger	Gleiter	Garnitur mit ENDKAPPEN	Garnitur mit ENDSTÜCKEN
100 cm	2	32	197	211
120 cm	2	36	211	225
140 cm	2	40	225	239
160 cm	2	48	239	253
180 cm	3	52	293	307
<hr/>				
200 cm	3	56	306	320
220 cm	3	64	321	335
240 cm	3	68	335	349
260 cm	3	72	348	362
280 cm	3	80	363	377
<hr/>				
300 cm	3	84	376	390
320 cm	3	88	390	404
340 cm	3	92	404	418
360 cm	4	96	458	472
380 cm	4	104	472	486
<hr/>				
400 cm	4	108	486	500
420 cm	4	112	500	514
440 cm	4	120	514	528
460 cm	4	124	528	542
480 cm	4	128	542	556
<hr/>				
500 cm	4	136	556	570
520 cm	4	144	570	584
540 cm	5	148	624	638
560 cm	5	152	638	652
580 cm	5	160	652	666
<hr/>				
Abzug per Wandlager			-34	-41

Auswahl Oberflächen:

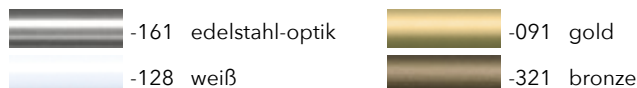

Garnitur-Nr. Endkappen

20-570

Tapa, eckig



Garnitur-Nr. Endstücke

20-571

Zylinder, eckig



20-572

Zylinder, rund



Bestandteile der Garnitur

Profil

Ø 20 mm



Träger Quad

WA 80/145 mm



Gleiter

Art.-Nr. 739



Ø 20 mm Quad

Bestellangaben: Garnitur-Nr., Farbcode, Länge · Unverbindlich empfohlene Verkaufspreise in EURO inkl. MwSt.

Standardgleiter (Art.-Nr. 739-xx)  alternativ Gleiter mit Öse (Art.-Nr. 740-xx)  ohne Aufpreis.

# Ø 20 mm Quad

## Profilgarnituren 1-läufig, Deckenmontage



TAPA, eckig - weiß - Garnitur-Nr. 20-670-128



TAPA, eckig - edelstahl-optik - Garnitur-Nr. 20-670-161

## Profilgarnituren 1-läufig, Deckenmontage



ZYLINDER, rund - gold - Garnitur-Nr. 20-772-091

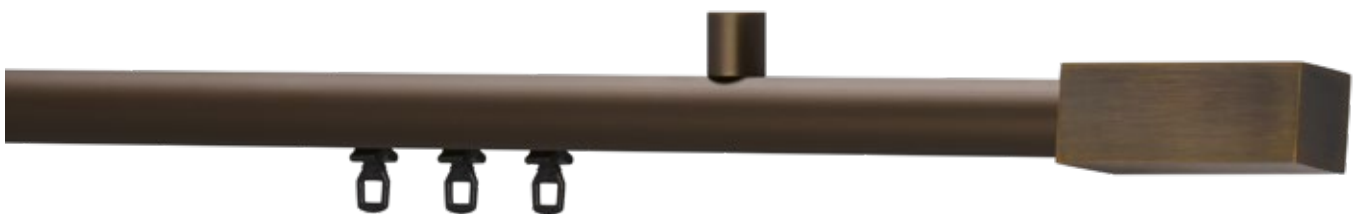

ZYLINDER, eckig - bronze - Garnitur-Nr. 20-771-321

Profilgarnituren 1-läufig, Deckenmontage

Länge	Träger	Gleiter	Garnitur mit ENDKAPPEN
100 cm	2	16	75
120 cm	2	18	82
140 cm	2	20	89
160 cm	2	24	96
180 cm	3	26	111
<hr/>			
200 cm	3	28	117
220 cm	3	32	125
240 cm	3	34	132
260 cm	3	36	138
280 cm	3	40	146
<hr/>			
300 cm	3	42	152
320 cm	3	44	159
340 cm	3	46	166
360 cm	4	48	181
380 cm	4	52	188
<hr/>			
400 cm	4	54	195
420 cm	4	56	202
440 cm	4	60	209
460 cm	4	62	216
480 cm	4	64	223
<hr/>			
500 cm	4	68	230
520 cm	4	72	237
540 cm	5	74	252
560 cm	5	76	259
580 cm	5	80	266

Abzug per Wandlager -5

Auswahl Oberflächen:

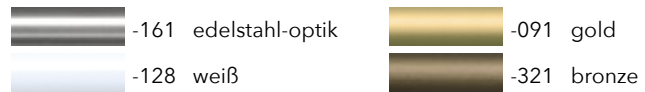

Garnitur-Nr. Endkappen

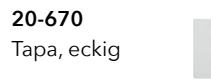

Bestandteile der Garnitur

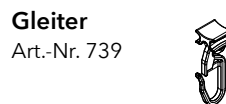

Profilgarnituren 1-läufig, Deckenmontage

Länge	Träger	Gleiter	Garnitur mit ENDKAPPEN	Garnitur mit ENDSTÜCKEN
100 cm	2	16	99	113
120 cm	2	18	106	120
140 cm	2	20	113	127
160 cm	2	24	120	134
180 cm	3	26	147	161
<hr/>				
200 cm	3	28	153	167
220 cm	3	32	161	175
240 cm	3	34	168	182
260 cm	3	36	174	188
280 cm	3	40	182	196
<hr/>				
300 cm	3	42	188	202
320 cm	3	44	195	209
340 cm	3	46	202	216
360 cm	4	48	229	243
380 cm	4	52	236	250
<hr/>				
400 cm	4	54	243	257
420 cm	4	56	250	264
440 cm	4	60	257	271
460 cm	4	62	264	278
480 cm	4	64	271	285
<hr/>				
500 cm	4	68	278	292
520 cm	4	72	285	299
540 cm	5	74	312	326
560 cm	5	76	319	333
580 cm	5	80	326	340

Abzug per Wandlager -17 -24

Auswahl Oberflächen:

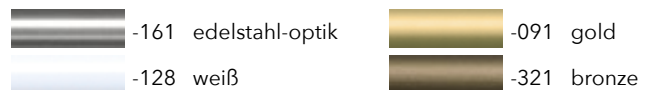

Garnitur-Nr. Endkappen

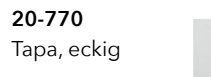

Garnitur-Nr. Endstücke



Bestandteile der Garnitur

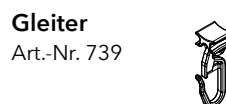



Ø 20 mm Quad

Bestellangaben: Garnitur-Nr., Farbcode, Länge · Unverbindlich empfohlene Verkaufspreise in EURO inkl. MwSt.

Standardgleiter (Art.-Nr. 739-xx) alternativ Gleiter mit Öse (Art.-Nr. 740-xx) ohne Aufpreis.

# Ø 20 mm Quad

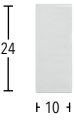
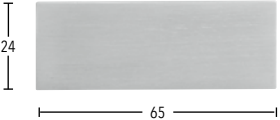
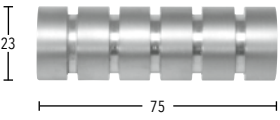
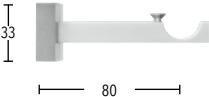
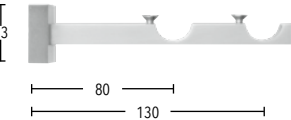
	ARTIKEL	OBERFLÄCHE	ARTIKEL-NR.	EURO / STK.
	ALUMINIUM-ROHR Ø 20 mm	edelstahl-optik	8020-161	20,00
	Lagerlänge 6 Meter	weiß	-128	20,00
	Preis € per Meter	gold	-091	20,00
		bronze	-321	20,00
	ALUMINIUM-ROHR Ø 20 mm	edelstahl-optik	8020-161	24,00
	Fixlänge (Zuschnitt)	weiß	-128	24,00
	Preis € per Meter	gold	-091	24,00
		bronze	-321	24,00
	ALUMINIUM-PROFIL Ø 20 mm	edelstahl-optik	8820-161	28,00
	Lagerlänge 6 Meter	weiß	-128	28,00
	Preis € per Meter	gold	-091	28,00
		bronze	-321	28,00
	ALUMINIUM-PROFIL Ø 20 mm	edelstahl-optik	8820-161	33,60
	Fixlänge (Zuschnitt)	weiß	-128	33,60
	Preis € per Meter	gold	-091	33,60
		bronze	-321	33,60
	Endkappe	edelstahl-optik	502070-161	11,00
	TAPA, eckig	weiß	-128	11,00
	für Ø 20 mm	gold	-091	11,00
	VE = 10 Stück	bronze	-321	11,00
	Endstück	edelstahl-optik	502071-161	18,00
	ZYLINDER, eckig	weiß	-128	18,00
	für Ø 20 mm	gold	-091	18,00
	VE = 10 Stück	bronze	-321	18,00
	Endstück	edelstahl-optik	502045-161	15,00
	ZYLINDER, rund	weiß	-128	15,00
	für Ø 20 mm	gold	-091	15,00
	VE = 10 Stück	bronze	-321	15,00
	WANDTRÄGER, 1-läufig	edelstahl-optik	602080-161	34,00
	WA 80 mm	weiß	-128	34,00
	für Ø 20 mm Rohre und Profile	gold	-091	34,00
	VE = 10 Stück	bronze	-321	34,00
	WANDTRÄGER, 2-läufig	edelstahl-optik	602015-161	40,00
	WA 80/130 mm	weiß	-128	40,00
	für Ø 20 mm Rohre und Profile	gold	-091	40,00
	VE = 10 Stück	bronze	-321	40,00

Unverbindlich empfohlene Verkaufspreise in EURO inkl. MwSt.

	ARTIKEL	OBERFLÄCHE	ARTIKEL-NR.	EURO / STK.
	TRÄGERVERLÄNGERUNG	edelstahl-optik	402040-161	14,00
	Länge 40 mm	weiß	-128	14,00
	VE = 10 Stück	gold	-091	14,00
		bronze	-321	14,00
	DECKENTRÄGER 3 mm	weiß	702013-128	8,00
	1-läufig	grau	-161	8,00
	Deckenabstand 21 mm	schwarz	-570	8,00
	VE = 10 Stück			
	DECKENTRÄGER 15 mm	edelstahl-optik	702015-161	18,00
	1-läufig	weiß	-128	18,00
	Deckenabstand 33 mm	gold	-091	20,00
	VE = 10 Stück	bronze	-321	20,00
	DECKENTRÄGER 35 mm	edelstahl-optik	702035-161	20,00
	1-läufig	weiß	-128	20,00
	Deckenabstand 53 mm	gold	-091	22,00
	VE = 10 Stück	bronze	-321	22,00
	DECKENTRÄGER 42 mm	edelstahl-optik	702043-161	29,00
	1-läufig	weiß	-128	29,00
	Deckenabstand 60 mm	gold	-091	34,00
	VE = 10 Stück	bronze	-321	34,00
	DECKENTRÄGER 500 mm	edelstahl-optik	702050-161	48,00
	1-läufig (kürzbar)	weiß	-128	48,00
	Deckenabstand 60-518 mm	gold	-091	54,00
	VE = 10 Stück			
	WANDLAGER	edelstahl-optik	302040-161	14,00
	für Ø 20 mm	weiß	-128	14,00
	VE = 10 Stück	gold	-091	14,00
		bronze	-321	14,00
	FLACHRING MIT KUNSTSTOFFEINLAGE	edelstahl-optik	202040-161	1,80
	ohne Faltenleghaken	weiß	-128	1,80
	Innen-Ø 34 mm, Außen-Ø 40 mm	gold	-091	1,80
	VE = 100 Stück	bronze	-321	1,80
	FALTENLEGHAKEN	weiß	8186-128	0,10
	für Flachringe Art.-Nr. 202040	silber	-161	0,10
	VE = 100 Stück	gold	-091	0,10
		braun	-321	0,10

Ø 20 mm Quad

# Ø 20 mm Quad

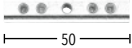
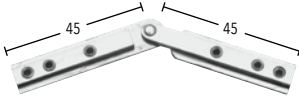
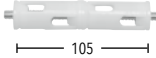
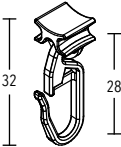
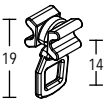
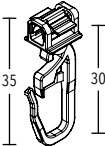
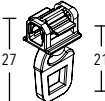
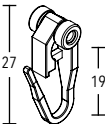
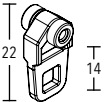
	ARTIKEL	OBERFLÄCHE	ARTIKEL-NR.	EURO / STK.
	PROFILVERBINDER VE = 10 Stück	silber	8993-00	10,00
	PROFILVERBINDER verstellbar VE = 10 Stück	silber	89931-00	24,00
	ROHRVERBINDER für Ø 20 mm Rohre VE = 10 Stück	weiß	83020-000	12,00
	GLEITER MIT FALTENLEGHAKEN VE = 100 Stück	weiß grau schwarz	739-00 -08 -57	0,10 0,10 0,10
	GLEITER MIT ÖSE VE = 100 Stück	weiß grau schwarz	740-00 -08 -57	0,10 0,10 0,10
	KLICK-GLEITER MIT FALTENLEGHAKEN VE = 100 Stück	weiß grau schwarz	742-00 -08 -57	0,30 0,30 0,30
	KLICK-GLEITER MIT ÖSE VE = 100 Stück	weiß grau schwarz	743-00 -08 -57	0,30 0,30 0,30
	ROLLENGLEITER MIT FALTENLEGHAKEN VE = 100 Stück	weiß grau schwarz	741-00 -08 -57	0,25 0,25 0,25
	ROLLENGLEITER MIT ÖSE VE = 100 Stück	weiß grau schwarz	748-00 -08 -57	0,25 0,25 0,25

Unverbindlich empfohlene Verkaufspreise in EURO inkl. MwSt.

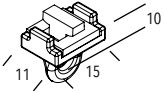
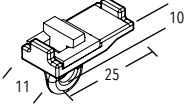

	<b>ARTIKEL</b>	<b>OBERFLÄCHE</b>	<b>ARTIKEL-NR.</b>	<b>EURO / STK.</b>
	FESTSTELLER	weiß	799-2-00	0,50
	für Profile	grau	-08	0,50
	VE = 100 Stück	schwarz	-57	0,50
	FESTSTELLER	weiß	799-4-00	0,50
	zur Abdeckung einer Ausklinkung	grau	-08	0,50
	für Profile	schwarz	-57	0,50
	VE = 100 Stück			

Ø 20 mm Classix

---

gold

Garnitur-Nr. 20-164-091





Ø 20 mm Classix

# Ø 20 mm Classix

## Ringgarnituren 1-läufig, Wandmontage



CLASSIX - edelstahl-optik - Garnitur-Nr. 20-160-161



ATHEN - gold - Garnitur-Nr. 20-164-091

## Ringgarnituren 2-läufig, Wandmontage



PARIS - weiß - Garnitur-Nr. 20-262-128



WIEN - bronze - Garnitur-Nr. 20-263-321

Ringgarnituren 1-läufig, Wandmontage

Länge	Träger	Ringe	Garnitur mit ENDKAPPEN	Garnitur mit ENDSTÜCKEN
100 cm	2	16	139	157
120 cm	2	18	147	165
140 cm	2	20	156	174
160 cm	2	24	168	186
180 cm	3	26	209	227
<hr/>				
200 cm	3	28	218	236
220 cm	3	32	230	248
240 cm	3	34	239	257
260 cm	3	36	247	265
280 cm	3	40	260	278
<hr/>				
300 cm	3	42	268	286
320 cm	3	44	277	295
340 cm	3	46	285	303
360 cm	4	48	326	344
380 cm	4	52	338	356
<hr/>				
400 cm	4	54	347	365
420 cm	4	56	356	374
440 cm	4	60	368	386
460 cm	4	62	377	395
480 cm	4	64	385	403
<hr/>				
500 cm	4	68	398	416
520 cm	4	72	410	428
540 cm	5	74	451	469
560 cm	5	76	459	477
580 cm	5	80	472	490
<hr/>				
Abzug per Wandlager			-28	-37

Auswahl Oberflächen:

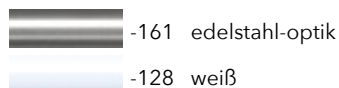

Garnitur-Nr. Endkappen

20-160  
Classix



Garnitur-Nr. Endstücke

20-161  
Prag



20-162  
Paris



20-163  
Wien



20-164\*  
Athen



Bestandteile der Garnitur

Rohr

Ø 20 mm



Träger Classix

WA 120 mm



Flachring mit

Faltenleghaken



\* nicht in -321 bronze verfügbar

Ringgarnituren 2-läufig, Wandmontage

Länge	Träger	Ringe	Garnitur mit ENDKAPPEN	Garnitur mit ENDSTÜCKEN
100 cm	2	32	229	247
120 cm	2	36	246	264
140 cm	2	40	264	282
160 cm	2	48	288	306
180 cm	3	52	346	364
<hr/>				
200 cm	3	56	363	381
220 cm	3	64	388	406
240 cm	3	68	405	423
260 cm	3	72	422	440
280 cm	3	80	447	465
<hr/>				
300 cm	3	84	464	482
320 cm	3	88	481	499
340 cm	3	92	498	516
360 cm	4	96	556	574
380 cm	4	104	580	598
<hr/>				
400 cm	4	108	598	616
420 cm	4	112	615	633
440 cm	4	120	640	658
460 cm	4	124	657	675
480 cm	4	128	674	692
<hr/>				
500 cm	4	136	699	717
520 cm	4	144	724	742
540 cm	5	148	781	799
560 cm	5	152	798	816
580 cm	5	160	823	841
<hr/>				
Abzug per Wandlager			-32	-41

Auswahl Oberflächen:

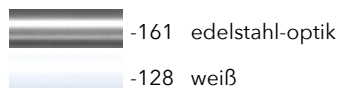

Garnitur-Nr. Endkappen

20-260  
Classix



Garnitur-Nr. Endstücke

20-261  
Prag



20-262  
Paris



20-263  
Wien



20-264\*  
Athen



Bestandteile der Garnitur

Rohr

Ø 20 mm



Träger Classix

WA 120/180 mm



Flachring mit

Faltenleghaken







Ø 20 mm Classix

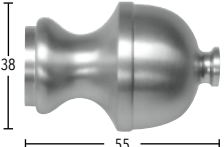
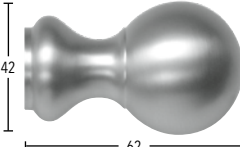
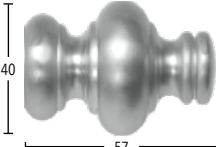

\* nicht in -321 bronze verfügbar

Bestellangaben: Garnitur-Nr., Farbcode, Länge · Unverbindlich empfohlene Verkaufspreise in EURO inkl. MwSt.

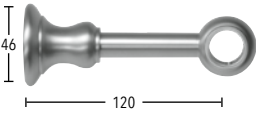
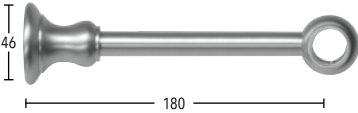
# Ø 20 mm Classix

	ARTIKEL	OBERFLÄCHE	ARTIKEL-NR.	EURO / STK.
	ALUMINIUM-ROHR Ø 20 mm	edelstahl-optik	8020-161	20,00
	Lagerlänge 6 Meter	weiß	-128	20,00
	Preis € per Meter	gold	-091	20,00
		bronze	-321	20,00
	ALUMINIUM-ROHR Ø 20 mm	edelstahl-optik	8020-161	24,00
	Fixlänge (Zuschnitt)	weiß	-128	24,00
	Preis € per Meter	gold	-091	24,00
		bronze	-321	24,00
	Endkappe	edelstahl-optik	502060-161	10,00
	CLASSIX	weiß	-128	10,00
	für Ø 20 mm	gold	-091	10,00
	VE = 10 Stück	bronze	-321	10,00
	Endstück	edelstahl-optik	502061-161	19,00
	PRAG	weiß	-128	19,00
	für Ø 20 mm	gold	-091	19,00
	VE = 10 Stück	bronze	-321	19,00
	Endstück	edelstahl-optik	502062-161	19,00
	PARIS	weiß	-128	19,00
	für Ø 20 mm	gold	-091	19,00
	VE = 10 Stück	bronze	-321	19,00
	Endstück	edelstahl-optik	502063-161	19,00
	WIEN	weiß	-128	19,00
	für Ø 20 mm	gold	-091	19,00
	VE = 10 Stück	bronze	-321	19,00
	Endstück	edelstahl-optik	502064-161	19,00
	ATHEN	weiß	-128	19,00
	für Ø 20 mm	gold	-091	19,00
	VE = 10 Stück			
	WANDTRÄGER, 1-läufig	edelstahl-optik	602002-161	32,00
	WA 120 mm (kürzbar)	weiß	-128	32,00
	für Ø 20 mm Rohre	gold	-091	32,00
	VE = 10 Stück	bronze	-321	32,00
	WANDTRÄGER, 1-läufig	edelstahl-optik	602018-161	34,00
	WA 180 mm (kürzbar)	weiß	-128	34,00
	für Ø 20 mm Rohre	gold	-091	34,00
	VE = 10 Stück	bronze	-321	34,00

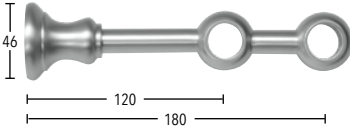
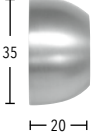
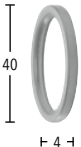
Unverbindlich empfohlene Verkaufspreise in EURO inkl. MwSt.

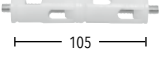
	ARTIKEL	OBERFLÄCHE	ARTIKEL-NR.	EURO / STK.
 <p>46 120 180</p>	WANDTRÄGER, 2-läufig	edelstahl-optik	602028-161	40,00
	WA 120/180 mm (kürzbar)	weiß	-128	40,00
	für Ø 20 mm Rohre	gold	-091	40,00
	VE = 10 Stück	bronze	-321	40,00
 <p>35 20</p>	WANDLAGER	edelstahl-optik	302040-161	14,00
	für Ø 20 mm	weiß	-128	14,00
	VE = 10 Stück	gold	-091	14,00
		bronze	-321	14,00
 <p>40 4</p>	FLACHRING MIT KUNSTSTOFFEINLAGE	edelstahl-optik	202040-161	1,80
	ohne Faltenleghaken	weiß	-128	1,80
	Innen-Ø 34 mm, Außen-Ø 40 mm	gold	-091	1,80
	VE = 100 Stück	bronze	-321	1,80
	FALTENLEGHAKEN	natur	8186-128	0,10
	für Flachringe Art.-Nr. 202040	silber	-161	0,10
	VE = 100 Stück	gold	-091	0,10
		braun	-321	0,10
 <p>105</p>	ROHRVERBINDER	natur	83020-000	12,00
	für Ø 20 mm Rohre			
	VE = 10 Stück			

Ø 28 mm Primo

---

schwarz

Garnitur-Nr. 28-740-570







# Ø 28 mm Primo

## Ringgarnituren 1-läufig, Wandmontage



TAPA - edelstahl-optik - Garnitur-Nr. 28-140-161



TAPA - schwarz - Garnitur-Nr. 28-140-570

## Ringgarnituren 2-läufig, Wandmontage



TAPA - weiß - Garnitur-Nr. 28-240-128



TAPA - gold - Garnitur-Nr. 28-240-091

Ringgarnituren 1-läufig, Wandmontage

Länge	Träger	Ringe	Garnitur mit ENDKAPPEN
100 cm	2	16	186
120 cm	2	18	201
140 cm	2	20	216
160 cm	2	24	238
180 cm	2	26	253
<hr/>			
200 cm	2	28	268
220 cm	3	32	323
240 cm	3	34	338
260 cm	3	36	353
280 cm	3	40	375
<hr/>			
300 cm	3	42	390
320 cm	3	44	406
340 cm	3	46	421
360 cm	3	48	436
380 cm	3	52	458
<hr/>			
400 cm	3	54	473
420 cm	3	56	488
440 cm	4	60	543
460 cm	4	62	558
480 cm	4	64	573
<hr/>			
500 cm	4	68	595
520 cm	4	72	618
540 cm	4	74	633
560 cm	4	76	648
580 cm	4	80	670

Abzug per Wandlager -22

Auswahl Oberflächen:

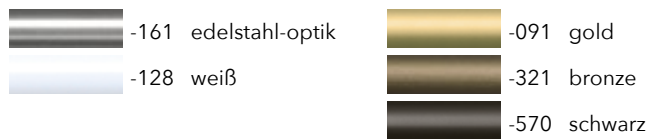

Garnitur-Nr. Endkappen

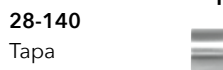

Bestandteile der Garnitur

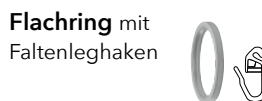
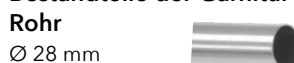

Ringgarnituren 2-läufig, Wandmontage

Länge	Träger	Ringe	Garnitur mit ENDKAPPEN
100 cm	2	32	323
120 cm	2	36	353
140 cm	2	40	383
160 cm	2	48	428
180 cm	2	52	458
<hr/>			
200 cm	2	56	488
220 cm	3	64	573
240 cm	3	68	603
260 cm	3	72	634
280 cm	3	80	678
<hr/>			
300 cm	3	84	708
320 cm	3	88	739
340 cm	3	92	769
360 cm	3	96	799
380 cm	3	104	844
<hr/>			
400 cm	3	108	874
420 cm	3	112	904
440 cm	4	120	989
460 cm	4	124	1019
480 cm	4	128	1049
<hr/>			
500 cm	4	136	1094
520 cm	4	144	1139
540 cm	4	148	1169
560 cm	4	152	1199
580 cm	4	160	1244

Abzug per Wandlager -20

Auswahl Oberflächen:

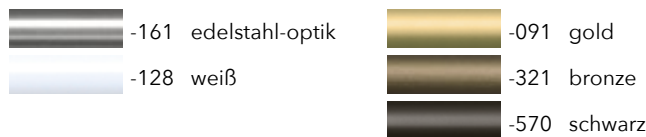

Garnitur-Nr. Endkappen

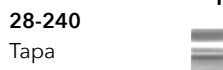

Bestandteile der Garnitur

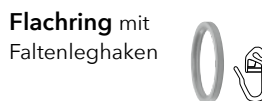
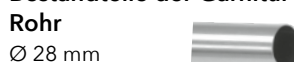

# Ø 28 mm Primo

## Profilgarnituren 1-läufig, Wandmontage



TAPA - weiß - Garnitur-Nr. 28-440-128



TAPA - bronze - Garnitur-Nr. 28-440-321

## Profilgarnituren 2-läufig, Wandmontage



TAPA - edelstahl-optik - Garnitur-Nr. 28-540-161







TAPA - schwarz - Garnitur-Nr. 28-540-570

Profilgarnituren 1-läufig, Wandmontage

Länge	Träger	Gleiter	Garnitur mit ENDKAPPEN
100 cm	2	16	137
120 cm	2	18	146
140 cm	2	20	155
160 cm	2	24	165
180 cm	2	26	174
<hr/>			
200 cm	2	28	183
220 cm	3	32	225
240 cm	3	34	234
260 cm	3	36	244
280 cm	3	40	253
<hr/>			
300 cm	3	42	262
320 cm	3	44	272
340 cm	3	46	281
360 cm	3	48	290
380 cm	3	52	300
<hr/>			
400 cm	3	54	309
420 cm	3	56	319
440 cm	4	60	360
460 cm	4	62	369
480 cm	4	64	379
<hr/>			
500 cm	4	68	388
520 cm	4	72	398
540 cm	4	74	407
560 cm	4	76	416
580 cm	4	80	426

Abzug per Wandlager -22

Auswahl Oberflächen:

	-161 edelstahl-optik		-091 gold
	-128 weiß		-321 bronze
			-570 schwarz

Garnitur-Nr. Endkappen

28-440  
Tapa 

Bestandteile der Garnitur

Profil   
Ø 28 mm

Träger Primo   
WA 80 mm





Gleiter   
Art.-Nr. 739

Profilgarnituren 2-läufig, Wandmontage

Länge	Träger	Gleiter	Garnitur mit ENDKAPPEN
100 cm	2	32	225
120 cm	2	36	244
140 cm	2	40	262
160 cm	2	48	281
180 cm	2	52	300
<hr/>			
200 cm	2	56	318
220 cm	3	64	378
240 cm	3	68	396
260 cm	3	72	415
280 cm	3	80	434
<hr/>			
300 cm	3	84	452
320 cm	3	88	471
340 cm	3	92	490
360 cm	3	96	508
380 cm	3	104	527
<hr/>			
400 cm	3	108	546
420 cm	3	112	565
440 cm	4	120	624
460 cm	4	124	642
480 cm	4	128	661
<hr/>			
500 cm	4	136	680
520 cm	4	144	699
540 cm	4	148	718
560 cm	4	152	736
580 cm	4	160	755

Abzug per Wandlager -20

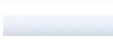
Auswahl Oberflächen:

	-161 edelstahl-optik		-091 gold
	-128 weiß		-321 bronze
			-570 schwarz

Garnitur-Nr. Endkappen

28-540  
Tapa 

Bestandteile der Garnitur

Profil   
Ø 28 mm

Träger Primo   
WA 80/160 mm

Gleiter   
Art.-Nr. 739

Bestellangaben: Garnitur-Nr., Farbcode, Länge · Unverbindlich empfohlene Verkaufspreise in EURO inkl. MwSt.

Standardgleiter (Art.-Nr. 739-xx)  alternativ Gleiter mit Öse (Art.-Nr. 740-xx)  ohne Aufpreis.

# Ø 28 mm Primo

Profilgarnituren 1-läufig, Deckenmontage

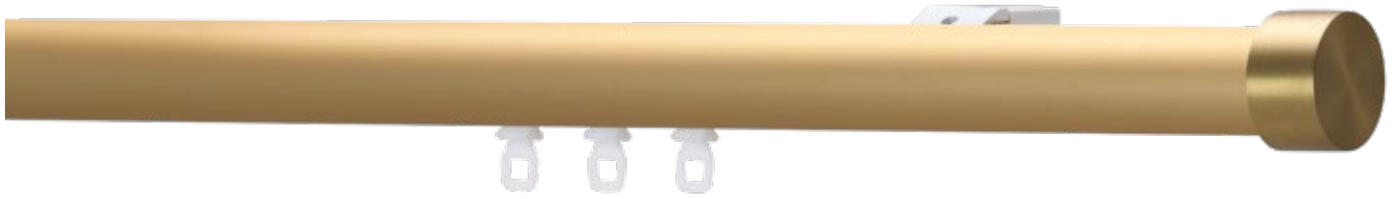

TAPA - gold - Garnitur-Nr. 28-640-091



TAPA - schwarz - Garnitur-Nr. 28-640-570

Profilgarnituren 1-läufig, Deckenmontage



TAPA - weiß - Garnitur-Nr. 28-740-128



TAPA - edelstahl-optik - Garnitur-Nr. 28-740-161

Profilgarnituren 1-läufig, Deckenmontage

Länge	Träger	Gleiter	Garnitur mit ENDKAPPEN
100 cm	2	16	89
120 cm	2	18	98
140 cm	2	20	107
160 cm	2	24	117
180 cm	2	26	126
<hr/>			
200 cm	2	28	135
220 cm	3	32	153
240 cm	3	34	162
260 cm	3	36	172
280 cm	3	40	181
<hr/>			
300 cm	3	42	190
320 cm	3	44	200
340 cm	3	46	209
360 cm	3	48	218
380 cm	3	52	228
<hr/>			
400 cm	3	54	237
420 cm	3	56	247
440 cm	4	60	264
460 cm	4	62	273
480 cm	4	64	283
<hr/>			
500 cm	4	68	292
520 cm	4	72	302
540 cm	4	74	311
560 cm	4	76	320
580 cm	4	80	330

Aufpreis per Wandlager 2

Auswahl Oberflächen:

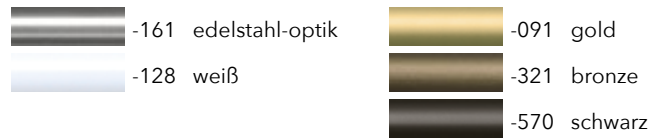

Garnitur-Nr. Endkappen

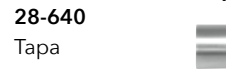

Bestandteile der Garnitur

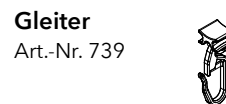

Profilgarnituren 2-läufig, Deckenmontage

Länge	Träger	Gleiter	Garnitur mit ENDKAPPEN
100 cm	2	16	113
120 cm	2	18	122
140 cm	2	20	131
160 cm	2	24	141
180 cm	2	26	150
<hr/>			
200 cm	2	28	159
220 cm	3	32	189
240 cm	3	34	198
260 cm	3	36	208
280 cm	3	40	217
<hr/>			
300 cm	3	42	226
320 cm	3	44	236
340 cm	3	46	245
360 cm	3	48	254
380 cm	3	52	264
<hr/>			
400 cm	3	54	273
420 cm	3	56	283
440 cm	4	60	312
460 cm	4	62	321
480 cm	4	64	331
<hr/>			
500 cm	4	68	340
520 cm	4	72	350
540 cm	4	74	359
560 cm	4	76	368
580 cm	4	80	378

Abzug per Wandlager -10

Auswahl Oberflächen:

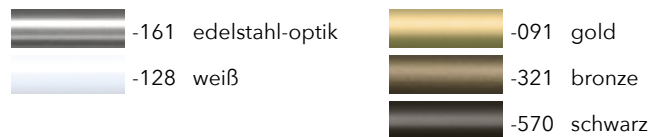

Garnitur-Nr. Endkappen

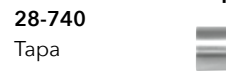

Bestandteile der Garnitur

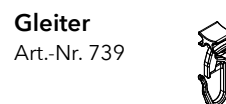

Bestellangaben: Garnitur-Nr., Farbcode, Länge · Unverbindlich empfohlene Verkaufspreise in EURO inkl. MwSt.



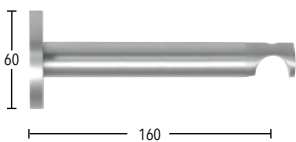
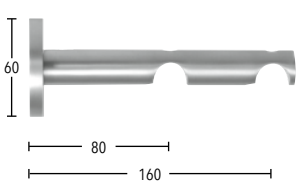
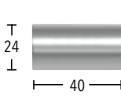

Standardgleiter (Art.-Nr. 739-xx) alternativ Gleiter mit Öse (Art.-Nr. 740-xx) ohne Aufpreis.

# Ø 28 mm Primo

	ARTIKEL	OBERFLÄCHE	ARTIKEL-NR.	EURO / STK.
	ALUMINIUM-ROHR Ø 28 mm	edelstahl-optik	8028-161	33,00
	Lagerlänge 6 Meter	weiß	-128	33,00
	Preis € per Meter	gold	-091	33,00
		bronze	-321	33,00
		schwarz	-570	33,00
	ALUMINIUM-ROHR Ø 28 mm	edelstahl-optik	8028-161	39,60
	Fixlänge (Zuschnitt)	weiß	-128	39,60
	Preis € per Meter	gold	-091	39,60
		bronze	-321	39,60
		schwarz	-570	39,60
	ALUMINIUM-PROFIL Ø 28 mm	edelstahl-optik	8828-161	38,00
	Lagerlänge 6 Meter	weiß	-128	38,00
	Preis € per Meter	gold	-091	38,00
		bronze	-321	38,00
		schwarz	-570	38,00
	ALUMINIUM-PROFIL Ø 28 mm	edelstahl-optik	8828-161	45,60
	Fixlänge (Zuschnitt)	weiß	-128	45,60
	Preis € per Meter	gold	-091	45,60
		bronze	-321	45,60
		schwarz	-570	45,60
	Endkappe	edelstahl-optik	502840-161	12,00
	TAPA	weiß	-128	12,00
	für Ø 28 mm	gold	-091	12,00
	VE = 10 Stück	bronze	-321	12,00
		schwarz	-570	12,00
	WANDTRÄGER, 1-läufig	edelstahl-optik	602880-161	32,00
	WA 80 mm	weiß	-128	32,00
	für Ø 28 mm Rohre und Profile	gold	-091	32,00
	VE = 10 Stück	bronze	-321	32,00
		schwarz	-570	32,00
	WANDTRÄGER, 1-läufig	edelstahl-optik	602816-161	36,00
	WA 160 mm	weiß	-128	36,00
	für Ø 28 mm Rohre und Profile	gold	-091	36,00
	VE = 10 Stück	bronze	-321	36,00
		schwarz	-570	36,00
	WANDTRÄGER, 2-läufig	edelstahl-optik	602826-161	40,00
	WA 80/160 mm	weiß	-128	40,00
	für Ø 28 mm Rohre und Profile	gold	-091	40,00
	VE = 10 Stück	bronze	-321	40,00
		schwarz	-570	40,00
	TRÄGERVERLÄNGERUNG	edelstahl-optik	402840-161	14,00
	Länge 40 mm	weiß	-128	14,00
	VE = 10 Stück	gold	-091	14,00
		bronze	-321	14,00
		schwarz	-570	14,00

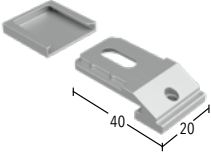
Unverbindlich empfohlene Verkaufspreise in EURO inkl. MwSt.

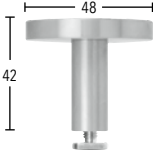
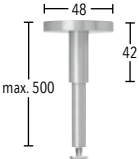
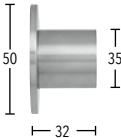

	ARTIKEL	OBERFLÄCHE	ARTIKEL-NR.	EURO / STK.
	DECKENTRÄGER 3 mm	weiß	702013-128	8,00
	1-läufig	grau	-161	8,00
	Deckenabstand 29 mm	schwarz	-570	8,00
	VE = 10 Stück			
	DECKENTRÄGER 15 mm	edelstahl-optik	702015-161	18,00
	1-läufig	weiß	-128	18,00
	Deckenabstand 41 mm	gold	-091	20,00
	VE = 10 Stück	bronze	-321	20,00
		schwarz	-570	18,00
	DECKENTRÄGER 35 mm	edelstahl-optik	702035-161	20,00
	1-läufig	weiß	-128	20,00
	Deckenabstand 61 mm	gold	-091	22,00
	VE = 10 Stück	bronze	-321	22,00
		schwarz	-570	20,00
	DECKENTRÄGER 42 mm	edelstahl-optik	702043-161	29,00
	1-läufig	weiß	-128	29,00
	Deckenabstand 68 mm	gold	-091	34,00
	VE = 10 Stück	bronze	-321	34,00
		schwarz	-570	29,00
	DECKENTRÄGER 500 mm	edelstahl-optik	702050-161	48,00
	1-läufig (kürzbar)	weiß	-128	48,00
	Deckenabstand 68-526 mm	gold	-091	54,00
	VE = 10 Stück	schwarz	-570	48,00
	WANDLAGER	edelstahl-optik	302840-161	22,00
	für Ø 28 mm	weiß	-128	22,00
	VE = 10 Stück	gold	-091	22,00
		bronze	-321	22,00
		schwarz	-570	22,00
	FLACHRING MIT KUNSTSTOFFEINLAGE	edelstahl-optik	202840-161	3,50
	ohne Faltenleghaken	weiß	-128	3,50
	Innen-Ø 53 mm, Außen-Ø 60 mm	gold	-091	3,50
	VE = 100 Stück	bronze	-321	3,50
		schwarz	-570	3,50
	FALTENLEGHAKEN	natur	8186-128	0,10
	für Flachringe Art.-Nr. 202740	silber	-161	0,10
	VE = 100 Stück	gold	-091	0,10
		braun	-321	0,10
		schwarz	-570	0,10
	PROFILVERBINDER	silber	8993-00	10,00
	VE = 10 Stück			





ED Vorhangschiene **MAXI**

ab Seite D 308



ED Vorhangschiene **STRAIGHT**

ab Seite D 309a



ED Vorhangschiene **RUND 4 mm**

ab Seite D 310



ED Vorhangschiene **RUND 6 mm**

ab Seite D 312

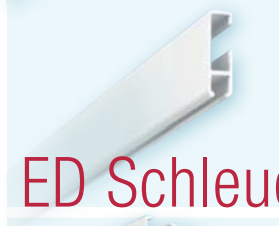

ED Schleuderschiene + Bilderschiene

ab Seite D 314

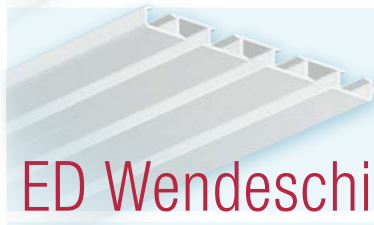

ED Wendeschiene

ab Seite D 316

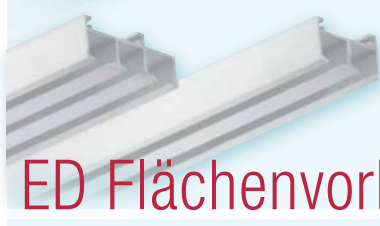

ED Flächenvorhangsystem **FLOW**

ab Seite D 318



ED Flächenvorhangschiene

ab Seite D 322



Flächenvorhangssysteme + Biegeservice

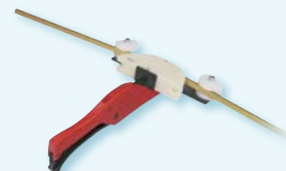

ab Seite D 324

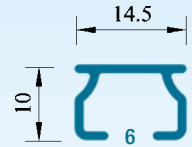

### Garnituren

Weiß oder alu matt, inklusive folgender Komponenten:



siehe Tabelle



1 Stück



1 Stück



siehe Tabelle





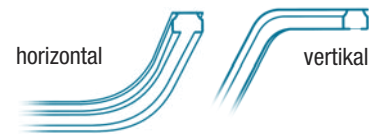















2 Stück



Flachschleuderschiene für die Deckenmontage zum Einnuten oder Anschrauben.

Biegungen siehe Seite D 328.

	Art.-Nr.	Länge	Gleiter	Schrauben	unverb. VK € (inkl. MwSt.)	
weiß	<b>021505</b>	-100	100 cm	16 Stück	4 Stück	
alu matt	<b>021508</b>	-120	120 cm	18 Stück	4 Stück	
		-140	140 cm	22 Stück	5 Stück	
		-160	160 cm	26 Stück	5 Stück	
		-180	180 cm	28 Stück	6 Stück	
		-200	200 cm	32 Stück	6 Stück	
		-220	220 cm	34 Stück	7 Stück	
		-240	240 cm	38 Stück	7 Stück	
		-260	260 cm	42 Stück	8 Stück	
		-280	280 cm	44 Stück	8 Stück	
		-300	300 cm	48 Stück	9 Stück	
		-320	320 cm	50 Stück	9 Stück	
		-340	340 cm	54 Stück	10 Stück	
		-360	360 cm	58 Stück	10 Stück	
		-380	380 cm	60 Stück	11 Stück	
		-400	400 cm	64 Stück	11 Stück	
		-420	420 cm	68 Stück	12 Stück	
		-440	440 cm	70 Stück	12 Stück	
		-460	460 cm	74 Stück	13 Stück	
		-480	480 cm	78 Stück	13 Stück	
		-500	500 cm	80 Stück	14 Stück	
		-520	520 cm	84 Stück	14 Stück	
		-540	540 cm	86 Stück	15 Stück	
		-560	560 cm	90 Stück	15 Stück	
		-580	580 cm	94 Stück	16 Stück	
		-600	600 cm	98 Stück	16 Stück	

Art.-Nr.	Artikel-Bezeichnung	VE	
			
<b>Aluminium-Vorhangschiene »maxi«</b>			
14,5 mm breit, 10 mm hoch, Laufbreite 6 mm, vorgebohrt, 1 Länge à 6 m			
100505	weiß 	6 m 30 m 60 m	*
100508	alu matt 	6 m 30 m 60 m	*
* Verschnitt ist selbst einzukalkulieren.			
<b>Endkappe mit Feststeller</b>			
100510	weiß 	10 Stück	
<b>Schienenverbinder</b>			
100511	weiß 	10 Stück	
100514	verzinkt 	10 Stück	
<b>Deckenträger</b>			
100512	weiß 	10 Stück 100 Stück	
100513	verzinkt 	10 Stück 100 Stück	
<b>Zwischen-Feststeller mit Grobgewinde</b>			
106002	weiß	100 Stück	
<b>Zwischen- und Endfeststeller</b>			
106015	transparent für Laufbreite 6 mm	100 Stück	
<b>Zwischen- und Endfeststeller</b>			
106011	weiß für Laufbreite 6 mm	100 Stück	
<b>Endfeststeller</b>			
106116	weiß für Laufbreite 6 mm	100 Stück	
<b>X-Gleiter mit Faltenleghaken</b>			
104804	weiß für Laufbreite 6 mm	100 Stück	
<b>Klick-Gleiter mit Faltenleghaken</b>			
An jeder Stelle einklickbar.			
104019	weiß für Laufbreite 6 mm	100 Stück	
104022	weiß, kurzer Haken für Laufbreite 6 mm	100 Stück	
<b>Drehgleiter mit Faltenleghaken</b>			
An jeder Stelle ein- und ausdrehbar.			
104805	weiß für Laufbreite 6 mm	100 Stück	
<b>Objektrolle</b>			
Extra flache Rollen mit PTFE-Beschichtung.			
104809	weiß für Laufbreite 6 mm	100 Stück	
<b>Spezial-Spanplattenschrauben mit kleinem Kopf</b>			
Senkkopf, Vollgewinde			
116246	3,0 x 30 mm, Pozidriv PZ 1, verzinkt, Kopf 6,0 mm Ø	200 Stück	
130868	3,0 x 30 mm, Torx T10, Edelstahl, Kopf 5,8 mm Ø	200 Stück	
326419	TORX-Bit mit Haltefunktion, T10, 89 mm lang 	1 Stück	

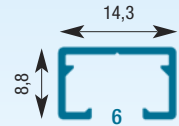
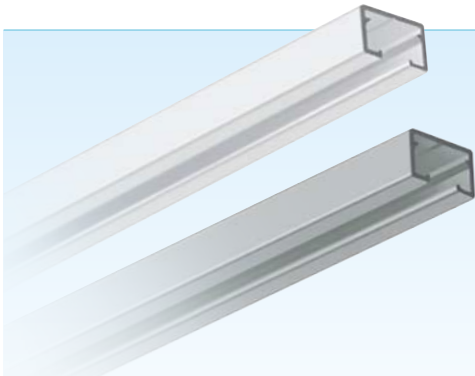

## Garnituren

Weiß oder alu matt, inklusive folgender Komponenten:

Schleuderschiene für die Deckenmontage zum Anschrauben.

Biegungen siehe Seite D 328.



siehe Tabelle



1 Stück



1 Stück



siehe Tabelle



2 Stück



	Art.-Nr.	Länge	Gleiter	Schrauben	unverb. VK € (inkl. MwSt.)	
weiß	<b>021525</b>	-100	100 cm	16 Stück	4 Stück	
alu matt	<b>021528</b>	-120	120 cm	18 Stück	4 Stück	
		-140	140 cm	22 Stück	5 Stück	
		-160	160 cm	26 Stück	5 Stück	
		-180	180 cm	28 Stück	6 Stück	
		-200	200 cm	32 Stück	6 Stück	
		-220	220 cm	34 Stück	7 Stück	
		-240	240 cm	38 Stück	7 Stück	
		-260	260 cm	42 Stück	8 Stück	
		-280	280 cm	44 Stück	8 Stück	
		-300	300 cm	48 Stück	9 Stück	
		-320	320 cm	50 Stück	9 Stück	
		-340	340 cm	54 Stück	10 Stück	
		-360	360 cm	58 Stück	10 Stück	
		-380	380 cm	60 Stück	11 Stück	
		-400	400 cm	64 Stück	11 Stück	
		-420	420 cm	68 Stück	12 Stück	
		-440	440 cm	70 Stück	12 Stück	
		-460	460 cm	74 Stück	13 Stück	
		-480	480 cm	78 Stück	13 Stück	
		-500	500 cm	80 Stück	14 Stück	
		-520	520 cm	84 Stück	14 Stück	
		-540	540 cm	86 Stück	15 Stück	
		-560	560 cm	90 Stück	15 Stück	
		-580	580 cm	94 Stück	16 Stück	
		-600	600 cm	98 Stück	16 Stück	

Art.-Nr.	Artikel-Bezeichnung	VE	
	<b>Aluminium-Vorhangschiene »STRAIGHT«</b> 14,3 mm breit, 8,8 mm hoch, Laufbreite 6 mm, mit Bohrspur und vorgebohrt, 1 Länge à 6 m		
100502	weiß	6 m 30 m 60 m	*
100503	alu matt	6 m 30 m 60 m	*
	* Verschnitt ist selbst einzukalkulieren.		
	<b>Endkappe mit Feststeller</b>		
100510	weiß	10 Stück	
	<b>Schienenverbinder</b>		
100615	Metall	10 Stück	
	<b>Zwischen-Feststeller mit Grobgewinde</b>		
106002	weiß	100 Stück	
	<b>Zwischen- und Endfeststeller</b>		
106015	transparent für Laufbreite 6 mm	100 Stück	
	<b>Zwischen- und Endfeststeller</b>		
106 011	weiß für Laufbreite 6 mm	100 Stück	
	<b>Endfeststeller</b>		
106116	weiß für Laufbreite 6 mm	100 Stück	
	<b>X-Gleiter mit Faltenleghaken</b>		
104804	weiß für Laufbreite 6 mm	100 Stück	
	<b>Klick-Gleiter mit Faltenleghaken</b> An jeder Stelle einklickbar.		
104019	weiß für Laufbreite 6 mm	100 Stück	
104022	weiß, kurzer Haken für Laufbreite 6 mm	100 Stück	
	<b>Drehgleiter mit Faltenleghaken</b> An jeder Stelle ein- und ausdrehbar.		
104805	weiß für Laufbreite 6 mm	100 Stück	
	<b>Objektrolle</b>		
104809	weiß für Laufbreite 6 mm	100 Stück	
	<b>Spezial-Spanplattenschrauben mit kleinem Kopf</b>		
116246	Senkkopf, Vollgewinde		
130868	3,0 x 30 mm, Pozidriv PZ1, verzinkt, Kopf 6,0 mm Ø	200 Stück	
326419	3,0 x 30 mm, Torx T10, Edelstahl, Kopf 5,8 mm Ø	200 Stück	
	TORX-Bit mit Haltefunktion, T10, 89 mm lang	1 Stück	

# Alu-Vorhangsschiene **RUND** 4mm

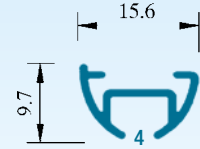

## Garnituren

Weiß, inklusive folgender Komponenten:



siehe Tabelle



1 Stück



1 Stück



siehe Tabelle

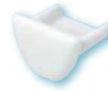

2 Stück

Flachschleuderschiene für die schnelle, unsichtbare Deckenmontage mit Spannriegeln. Keine Laufbeschädigung durch Schrauben.

Biegungen siehe Seite D 328.

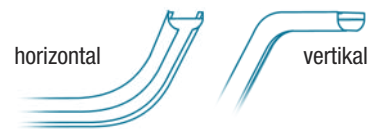

	Art.-Nr.	Länge	Gleiter	Spannriegel	unverb. VK € (inkl. MwSt.)
weiß <b>021501</b>	-100	100 cm	16 Stück	3 Stück	
	-120	120 cm	18 Stück	3 Stück	
	-140	140 cm	22 Stück	4 Stück	
	-160	160 cm	26 Stück	4 Stück	
	-180	180 cm	28 Stück	5 Stück	
	-200	200 cm	32 Stück	5 Stück	
	-220	220 cm	34 Stück	5 Stück	
	-240	240 cm	38 Stück	6 Stück	
	-260	260 cm	42 Stück	6 Stück	
	-280	280 cm	44 Stück	6 Stück	
	-300	300 cm	48 Stück	7 Stück	
	-320	320 cm	50 Stück	7 Stück	
	-340	340 cm	54 Stück	7 Stück	
	-360	360 cm	58 Stück	8 Stück	
	-380	380 cm	60 Stück	8 Stück	
	-400	400 cm	64 Stück	8 Stück	
	-420	420 cm	68 Stück	9 Stück	
	-440	440 cm	70 Stück	9 Stück	
	-460	460 cm	74 Stück	9 Stück	
	-480	480 cm	78 Stück	10 Stück	
	-500	500 cm	80 Stück	10 Stück	
	-520	520 cm	84 Stück	10 Stück	
	-540	540 cm	86 Stück	11 Stück	
	-560	560 cm	90 Stück	11 Stück	
	-580	580 cm	94 Stück	11 Stück	
	-600	600 cm	98 Stück	12 Stück	





Art.-Nr. Artikel-Bezeichnung VE

**Aluminium-Vorhangschiene »rund« 4 mm**

15,6 mm breit, 9,7 mm hoch, Laufbreite 4 mm,  
1 Länge à 6 m

100501 weiß  6 m  
30 m  
60 m

\* Verschnitt ist selbst einzukalkulieren.

**Endkappe**

100530 weiß  10 Stück

**Decken- und Wandträger-Spannriegel**

Metall verzinkt

10 Stück  
100 Stück

104302 mit angenieteter Unterlegscheibe

**Zwischen- und Endfeststeller**

106014 transparent  für Laufbreite 4 mm 100 Stück 



**Zwischen- und Endfeststeller** für Laufbreite 4 mm 

106012 Kunststoff weiß 100 Stück



**Metall + Kunststoff**

106013 Kunststoff transp. 100 Stück

**Endfeststeller**



106117 weiß  für Laufbreite 4 mm 100 Stück 

**X-Gleiter** mit Faltenleghaken

104904 weiß  für Laufbreite 4 mm 100 Stück 

**Klick-Gleiter** mit Faltenleghaken



An jeder Stelle einklickbar.

104018 weiß  für Laufbreite 4 mm 100 Stück 

104021 weiß, kurzer Haken  für Laufbreite 4 mm 100 Stück

**Drehgleiter** mit Faltenleghaken

An jeder Stelle ein- und ausdrehbar.

104806 weiß  für Laufbreite 4 mm 100 Stück 

**Gipskartondübel »Mini« mit Schraube**

Kurze Dübellänge von 30 mm und nur 10 mm Kopfdurchmesser.

Selbstbohrende Spitze und scharfes, selbstschneidendes Gewinde.

Vorsteckmontage, Bit in gleicher Größe für Schraube und Dübel einsetzen,

sitzt bündig und beschädigt nicht die Plattenoberfläche.

117067 Mit Seko-Schraube 3,0 x 25 mm, 5 mm Kopf-Ø 200 Stück 

# Alu-Vorhangschiene **RUND** 6 mm

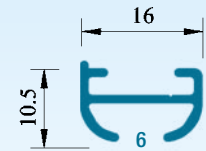
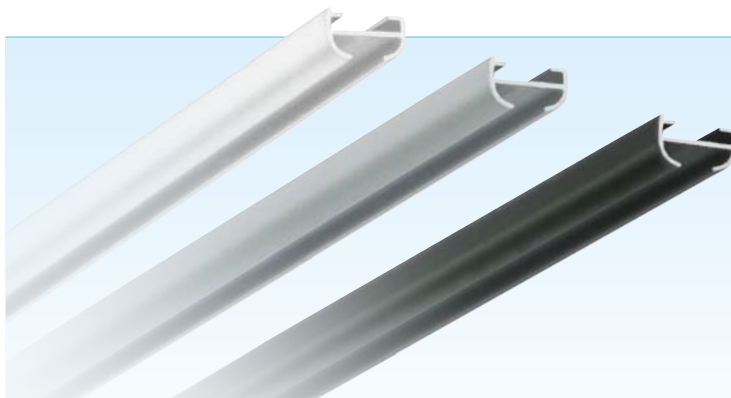

## Garnituren

Weiß, alu matt oder schwarz, inklusive folgender Komponenten:



siehe Tabelle



1 Stück



1 Stück



siehe Tabelle



2 Stück

Flachschleuderschiene für die schnelle, unsichtbare Deckenmontage mit Clips oder Spannriegeln. Keine Laufbeschädigung durch Schrauben.

Biegungen siehe Seite D 328.



	Art.-Nr.	Länge	Gleiter	Spannriegel
weiß <b>021515</b>	-100	100 cm	16 Stück	3 Stück
alu matt <b>021518</b>	-120	120 cm	18 Stück	3 Stück
schwarz <b>021519</b>	-140	140 cm	22 Stück	4 Stück
	-160	160 cm	26 Stück	4 Stück
	-180	180 cm	28 Stück	5 Stück
	-200	200 cm	32 Stück	5 Stück
	-220	220 cm	34 Stück	5 Stück
	-240	240 cm	38 Stück	6 Stück
	-260	260 cm	42 Stück	6 Stück
	-280	280 cm	44 Stück	6 Stück
	-300	300 cm	48 Stück	7 Stück
	-320	320 cm	50 Stück	7 Stück
	-340	340 cm	54 Stück	7 Stück
	-360	360 cm	58 Stück	8 Stück
	-380	380 cm	60 Stück	8 Stück
	-400	400 cm	64 Stück	8 Stück
	-420	420 cm	68 Stück	9 Stück
	-440	440 cm	70 Stück	9 Stück
	-460	460 cm	74 Stück	9 Stück
	-480	480 cm	78 Stück	10 Stück
	-500	500 cm	80 Stück	10 Stück
	-520	520 cm	84 Stück	10 Stück
	-540	540 cm	86 Stück	11 Stück
	-560	560 cm	90 Stück	11 Stück
	-580	580 cm	94 Stück	11 Stück
	-600	600 cm	98 Stück	12 Stück



Art.-Nr.	Artikel-Bezeichnung	VE
	<b>Aluminium-Vorhangschiene »rund« 6 mm</b> 16 mm breit, 10,5 mm hoch, Laufbreite 6 mm, 1 Länge à 6 m	
100515	weiß	6 m 30 m
100518	alu matt	60 m
100519	schwarz matt	
* Verschnitt ist selbst einzukalkulieren.		
	<b>Endkappe</b>	10 Stück
100520	weiß	
100523	alu matt	
100521	schwarz	
100527	<b>Schienenverbinder</b>	10 Stück
100524	<b>Deckenträger-Clip</b>	10 Stück 100 Stück
	<b>Decken- und Wandträger-Spannriegel</b>	
	<b>Kunststoff</b>	10 Stück
100525	weiß	100 Stück
100526	schwarz	
	<b>Metall verzinkt</b>	10 Stück
104302	mit angenieteter Unterlegscheibe	100 Stück
	<b>Zwischen- und Endfeststeller</b> für Laufbreite 6 mm	
106015	transparent	100 Stück
104032	grau	100 Stück
	<b>Zwischen- und Endfeststeller</b> für Laufbreite 6 mm	
106011	Kunststoff weiß	100 Stück
106024	Kunststoff schwarz	100 Stück
	<b>mit rutschhemmender Gummieinlage</b>	
106019	Kunststoff weiß	100 Stück
112366	Kunststoff grau	100 Stück
	<b>Metall + Kunststoff</b>	
106018	Kunststoff weiß	100 Stück
	<b>Endfeststeller</b> für Laufbreite 6 mm	
106116	weiß	100 Stück
	<b>X-Gleiter</b> mit Faltenleghaken für Laufbreite 6 mm	
104804	weiß	100 Stück
	<b>Klick-Gleiter</b> mit Faltenleghaken für Laufbreite 6 mm	
	An jeder Stelle einklickbar.	
104019	weiß, langer Haken	100 Stück
104022	weiß, kurzer Haken	100 Stück
104030	grau, langer Haken	100 Stück
104031	grau, kurzer Haken	100 Stück
	<b>Drehgleiter</b> mit Faltenleghaken für Laufbreite 6 mm	
	An jeder Stelle ein- und ausdrehbar.	
104805	weiß	100 Stück

# Alu-Vorhangschiene HIGH 6 mm

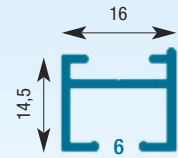
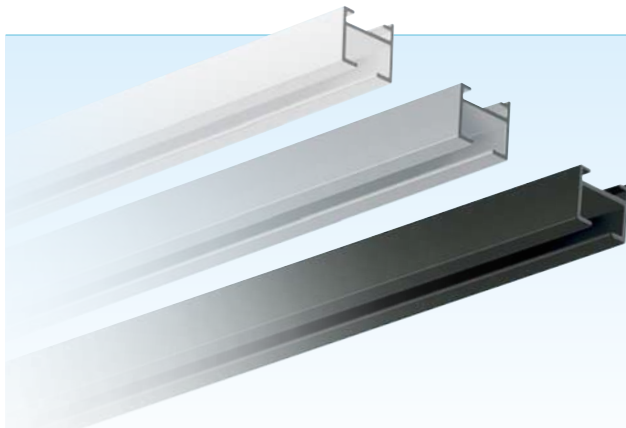

Schleuderschiene für die schnelle, unsichtbare Deckenmontage mit Clips oder Spannriegeln. Keine Laufbeschädigung durch Schrauben.

Biegungen siehe Seite D 328.

## Garnituren

Weiß, alu matt oder schwarz, inklusive folgender Komponenten:



siehe Tabelle



1 Stück



1 Stück



siehe Tabelle



2 Stück



horizontal



vertikal

	Art.-Nr.	Länge	Gleiter	Spannriegel
weiß <b>021540</b>	-100	100 cm	16 Stück	3 Stück
alu matt <b>021541</b>	-120	120 cm	18 Stück	3 Stück
schwarz <b>021542</b>	-140	140 cm	22 Stück	4 Stück
	-160	160 cm	26 Stück	4 Stück
	-180	180 cm	28 Stück	5 Stück
	-200	200 cm	32 Stück	5 Stück
	-220	220 cm	34 Stück	5 Stück
	-240	240 cm	38 Stück	6 Stück
	-260	260 cm	42 Stück	6 Stück
	-280	280 cm	44 Stück	6 Stück
	-300	300 cm	48 Stück	7 Stück
	-320	320 cm	50 Stück	7 Stück
	-340	340 cm	54 Stück	7 Stück
	-360	360 cm	58 Stück	8 Stück
	-380	380 cm	60 Stück	8 Stück
	-400	400 cm	64 Stück	8 Stück
	-420	420 cm	68 Stück	9 Stück
	-440	440 cm	70 Stück	9 Stück
	-460	460 cm	74 Stück	9 Stück
	-480	480 cm	78 Stück	10 Stück
	-500	500 cm	80 Stück	10 Stück
	-520	520 cm	84 Stück	10 Stück
	-540	540 cm	86 Stück	11 Stück
	-560	560 cm	90 Stück	11 Stück
	-580	580 cm	94 Stück	11 Stück
	-600	600 cm	98 Stück	12 Stück

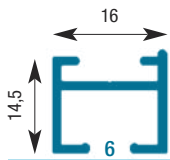

# Vorhangschiene HIGH Einzelteile

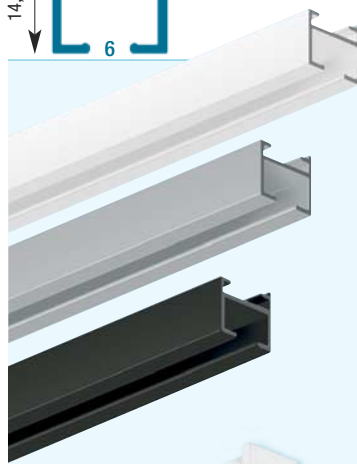

Art.-Nr.	Artikel-Bezeichnung	VE
	<b>Aluminium-Vorhangschiene »HIGH« 6 mm</b> 16 mm breit, 14,5 mm hoch, Laufbreite 6 mm, horizontal und vertikal biegsam, 1 Länge à 6 m	
100540	weiß	6 m 30 m 60 m
100541	alu matt	
100542	schwarz matt	
* Verschnitt ist selbst einzukalkulieren.		
	<b>Endkappe</b>	10 Stück
100544	weiß	
100545	alu matt	
100543	schwarz	
100527	<b>Schienenverbinder</b>	10 Stück
100524	<b>Deckenträger-Clip</b>	10 Stück 100 Stück
	<b>Decken- und Wandträger-Spannriegel</b>	
	<b>Kunststoff</b>	10 Stück 100 Stück
100525	weiß	
100526	schwarz	
	<b>Metall verzinkt</b>	10 Stück 100 Stück
104302	mit angenieteter Unterscheibe	
	<b>Zwischen- und Endfeststeller</b> für Laufbreite 6 mm	
106015	transparent	100 Stück
104032	grau	100 Stück
	<b>Zwischen- und Endfeststeller</b> für Laufbreite 6 mm	
106011	Kunststoff weiß	100 Stück
106024	Kunststoff schwarz	100 Stück
	<b>mit rutschhemmender Gummieinlage</b>	
106019	Kunststoff weiß	100 Stück
112366	Kunststoff grau	100 Stück
	<b>Metall + Kunststoff</b>	
106018	Kunststoff weiß	100 Stück
	<b>Endfeststeller</b> für Laufbreite 6 mm	
106116	weiß	100 Stück
	<b>X-Gleiter</b> mit Faltenleghaken für Laufbreite 6 mm	
104804	weiß	100 Stück
	<b>Klick-Gleiter</b> mit Faltenleghaken für Laufbreite 6 mm	
	An jeder Stelle einklickbar.	
104019	weiß, langer Haken	100 Stück
104022	weiß, kurzer Haken	100 Stück
104030	grau, langer Haken	100 Stück
104031	grau, kurzer Haken	100 Stück
	<b>Drehgleiter</b> mit Faltenleghaken für Laufbreite 6 mm	
	An jeder Stelle ein- und ausdrehbar.	
104805	weiß	100 Stück



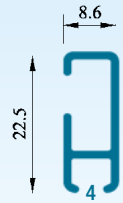
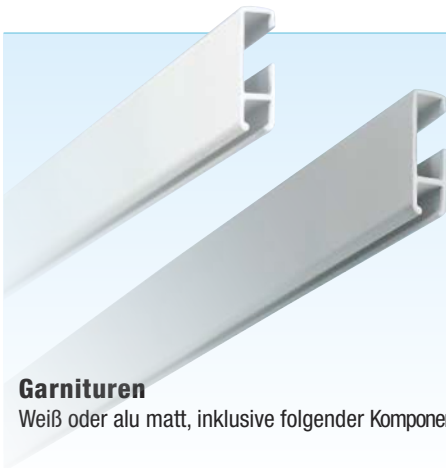

## Garnituren

Weiß oder alu matt, inklusive folgender Komponenten:

Schleuderschiene für einläufige Garnituren zur Wand- und Deckenmontage. Aus Einzelteilen auch als Bilderschiene im privaten und gewerblichen Bereich zu verwenden. Die Bilder können ohne Wandbeschädigung positioniert werden.

Biegungen siehe Seite D 328.



siehe Tabelle



1 Stück



1 Stück

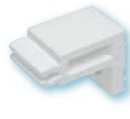

siehe Tabelle



2 Stück



horizontal

Farbe	Art.-Nr.	Länge	Gleiter	Wandträger	unverb. VK € (inkl. MwSt.)
weiß	<b>021620</b>	-100	100 cm	16 Stück	2 Stück
alu matt	<b>021630</b>	-120	120 cm	18 Stück	2 Stück
		-140	140 cm	22 Stück	3 Stück
		-160	160 cm	26 Stück	3 Stück
		-180	180 cm	28 Stück	3 Stück
		-200	200 cm	32 Stück	4 Stück
		-220	220 cm	34 Stück	4 Stück
		-240	240 cm	38 Stück	4 Stück
		-260	260 cm	42 Stück	4 Stück
		-280	280 cm	44 Stück	5 Stück
		-300	300 cm	48 Stück	5 Stück
		-320	320 cm	50 Stück	5 Stück
		-340	340 cm	54 Stück	5 Stück
		-360	360 cm	58 Stück	6 Stück
		-380	380 cm	60 Stück	6 Stück
		-400	400 cm	64 Stück	6 Stück
		-420	420 cm	68 Stück	7 Stück
		-440	440 cm	70 Stück	7 Stück
		-460	460 cm	74 Stück	7 Stück
		-480	480 cm	78 Stück	7 Stück
		-500	500 cm	80 Stück	8 Stück
		-520	520 cm	84 Stück	8 Stück
		-540	540 cm	86 Stück	8 Stück
		-560	560 cm	90 Stück	9 Stück
		-580	580 cm	94 Stück	9 Stück
		-600	600 cm	98 Stück	9 Stück

Art.-Nr.	Artikel-Bezeichnung	VE
	<b>Schleuderschiene</b> 8,6 mm breit, 22,5 mm hoch, Laufbreite 4 mm, 1 Länge à 6 m	
100620	weiß	6 m
100630	alu matt	30 m
	* Verschnitt ist selbst einzukalkulieren.	
	<b>Enddeckel</b>	
126130	weiß	10 Stück
126132	alu matt	
	<b>Profilverbinder</b>	
126134	weiß	10 Stück
	<b>Deckenträger für Schleuderschiene</b>	
126056	weiß	10 Stück
	<b>Wandträger für Schleuderschiene</b>	
126057	weiß	10 Stück
	<b>Zwischen- und Endfeststeller</b>	
106012	weiß für Laufbreite 4 mm	100 Stück
	<b>Endfeststeller</b>	
106117	weiß für Laufbreite 4 mm	100 Stück
	<b>X-Gleiter mit Faltenleghaken</b>	
104904	weiß für Laufbreite 4 mm	100 Stück
	<b>Klick-Gleiter mit Faltenleghaken</b> An jeder Stelle einklickbar.	
104018	weiß für Laufbreite 4 mm	100 Stück
104021	weiß, kurzer Haken für Laufbreite 4 mm	100 Stück
	<b>Einzelteile für Bilderschienen</b>	
126135	<b>Wandmontageclip für Bilderschiene</b> weiß	10 Stück
126078	<b>Wand- und Deckenträger mit Knebel</b> weiß	20 Stück
126078-2	<b>Distanzstück für Knebelträger, 1 cm</b> weiß	20 Stück
130101	<b>Bilderaufhänger-Oberteil</b> nickel	20 Stück
130102	<b>Bilderaufhänger-Unterteil</b> nickel	20 Stück
	<b>Bilderaufhänger-Nylonseil</b> transparent	
130112	2 mm Ø 150 cm lang	20 Stück
130110-1	2 mm Ø Rolle à 100 m	1 Rolle 10 Rollen
	<b>Bilderaufhänger-Perlonkordel</b> weiß	
126022	2 mm Ø	Rolle 250 m
130120	<b>Bilderset komplett</b> Bilderaufhänger-Ober- und Unterteil mit 150 cm Nylonseil, Belastung: max. 4 kg/St.	10 Stück
130121	<b>Click-Bilderset komplett</b> Nachträglich an beliebiger Stelle einclipsbar. Bilderaufhänger-Unterteil und Click-Einhängehaken mit 150 cm Nylonseil, Belastung: max. 4 kg/St.	10 Stück



Art.-Nr.	Artikel-Bezeichnung	VE
<b>MODIE Alu-Bilderschiene</b>		
Mo007-570	10 x 25 mm, Laufbreite 4 mm schwarz-matt 1 Länge à 5,8 m	5,8 m
Mo007-570-M	Mustergarnitur	1 St.
Mo986-570	<b>Seitenkappen</b> schwarz	1 Paar
Mo008-000	<b>Verbinder</b> Metall	1 St.
<b>MODIE Gleiterkette</b>		
Mo643-570	Kordel mit Gleitern für 4 mm-Läufe, 1.000 Gleiter mit einem von Abstand 80 mm schwarz	Rolle 80 m
<b>Faltenleghaken</b>		
112389	einfach schwarz	100 St.
107047	doppelt schwarz	100 St.
<b>MODIE Seitenhalter 90°</b>		
Mo566-000	zur Ausrichtung der ersten und letzten Falte, mit Öse für Schleuderstab transparent fixe Breite 77 mm	10 St. 50 St.
Mo985-570	<b>Wandträger</b> Metall schwarz (zur Verwendung mit Mo982-570)	1 St.
Mo982-570	<b>Deckenträger</b> schwarz	1 St.
Mo984-570	<b>Wandträger Abdeckung</b> Metall schwarz	1 St.
Mo987-570	<b>Wandträger / Deckenträger</b> schwarz	1 St.
Mo109-000	<b>Wandclip für Schiene</b>	100 St.
130120	<b>Bilderset komplett</b> Bilderaufhänger-Ober- und Unterteil mit 150 cm Nylonseil, Belastung: max. 4 kg/St.	10 St.
130121	<b>Click-Bilderset komplett</b> Nachträglich an beliebiger Stelle einclipsbar. Bilderaufhänger-Unterteil und Click-Einhängehaken mit 150 cm Nylonseil, Belastung: max. 4 kg/St.	10 St.
<b>Zwischenfeststeller für 4 mm-Lauf</b>		
106029	Kunststoff schwarz mit rutschhemmender Gummieinlage	100 St.
106028	Kunststoff weiß mit rutschhemmender Gummieinlage	100 St.
106032	Metall + Kunststoff schwarz	100 St.
106013	Metall + Kunststoff transparent	100 St.
106012	Kunststoff weiß	100 St.
104904	<b>X-Gleiter</b> für 4 mm-Lauf mit Faltenleghaken weiß	100 St.
104047	<b>Clie-Gleiter</b> für 4 mm-Lauf mit Haken lang schwarz	100 St.
104048	mit Haken kurz schwarz	100 St.
104018	mit Haken lang weiß	100 St.
104021	mit Haken kurz weiß	100 St.



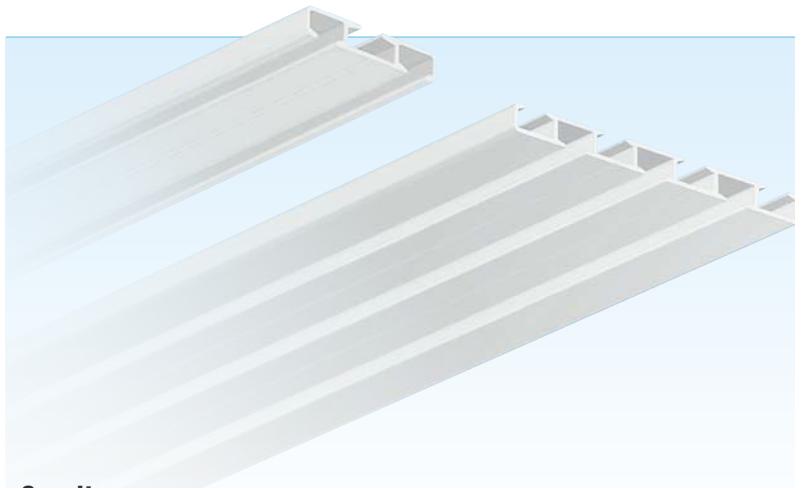

Die Objektschiene mit den vielen Möglichkeiten: Befestigung mit Schrauben oder Clips, Verwendung als Flächenvorhang- oder Gardinenschiene.

Die 1+2-Laufschiene ist horizontal biegsam, bitte geben Sie an, welcher Lauf genutzt werden soll, die Mindestlänge einer Retoure beträgt 15 cm, siehe Seite D 328.

Alternativ dazu können Sie auch unseren Retourenbogen nutzen, siehe nächste Seite.



## Garnituren

Weiß, mit 2 Enddeckeln und Gleitern (Anzahl siehe Tabelle)

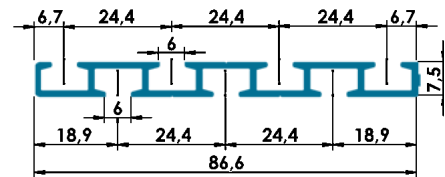
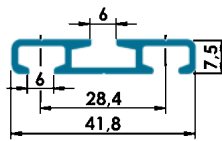
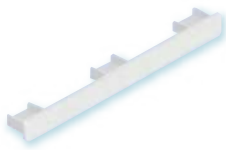

System	1 + 2 -Lauf		3 + 4 -Lauf	
Art.-Nr. / Länge	021720-		021740-	
cm	Gleiter	unverb. VK € (inkl. MwSt.)	Gleiter	unverb. VK € (inkl. MwSt.)
100	32 Stück		64 Stück	
120	40 Stück		80 Stück	
140	44 Stück		88 Stück	
160	52 Stück		104 Stück	
180	60 Stück		120 Stück	
200	64 Stück		128 Stück	
220	72 Stück		144 Stück	
240	76 Stück		152 Stück	
260	84 Stück		168 Stück	
280	92 Stück		184 Stück	
300	96 Stück		192 Stück	
320	104 Stück		208 Stück	
340	108 Stück		216 Stück	
360	116 Stück		232 Stück	
380	120 Stück		240 Stück	
400	128 Stück		256 Stück	
420	136 Stück		272 Stück	
440	140 Stück		280 Stück	
460	148 Stück		296 Stück	
480	156 Stück		312 Stück	
500	160 Stück		320 Stück	
520	168 Stück		336 Stück	
540	172 Stück		344 Stück	
560	180 Stück		360 Stück	
580	188 Stück		376 Stück	
600	196 Stück		392 Stück	

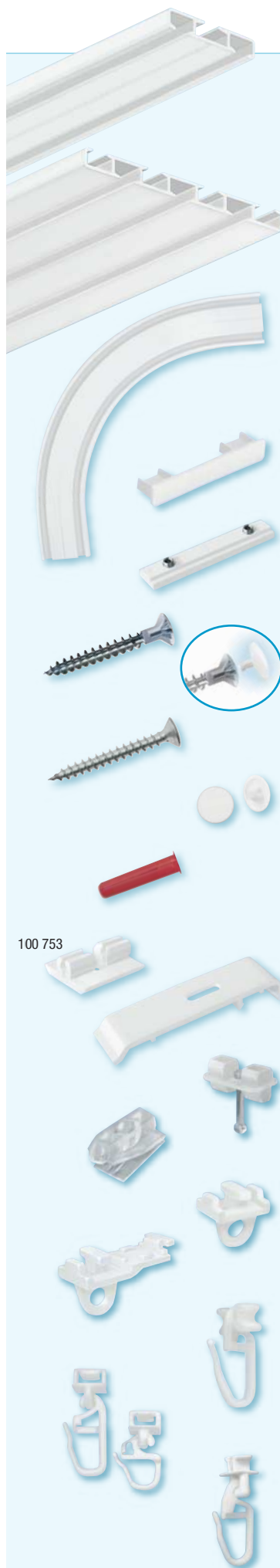

Art.-Nr.	Artikel-Bezeichnung	VE
	<b>Wendeschiene</b> weiß, Laufbreite 6 mm, mit Bohrspur, 1 Länge à 6 m	
100720	1 + 2 -Lauf	6 m 30 m
100740	3 + 4 -Lauf	6 m 30 m
	* Verschnitt ist selbst einzukalkulieren.	
	<b>Bogenstück</b> für 1+2-Lauf	
100710	90°, Alu, weiß      Abmessung: 200 x 200 mm	1 Stück
	<b>Enddeckel</b>	
126058	für 1+2-Lauf, weiß	20 Stück
126059	für 3+4-Lauf, weiß	20 Stück
100750	<b>Profilverbinder</b>	10 Stück
116213-K	<b>Schraube PZ mit Kopflochbohrung</b> 4,5 x 50 mm Vollgewinde      gleitbeschichtet	100 Stück
126101	<b>Abdeckkappe</b> für Schrauben mit Kopflochbohrung weiß, 14 mm Ø, 2,5 mm Dorn	200 Stück
116213	<b>Schraube PZ</b> 4,5 x 50 mm Vollgewinde      gleitbeschichtet	200 Stück
126100	<b>Abdeckkappe</b> für Standard-PZ-Schrauben weiß, 12 mm Ø, für PZ-Schrauben-Ø 3,5 – 5,0 mm	200 Stück
117091	<b>Quadro Dübel</b> für Schrauben-Ø 4,0 – 5,0 mm rot, 6 mm Ø	250 Stück
	Befestigungsmaterial im <i>Katalog BP.12</i> • Schrauben: Seite <i>B 26</i> • Schrauben mit Kopflochbohrung und Kappen: Seite <i>B 27</i> • Dübel: Seite <i>B 21</i> •	
100753	<b>Deckenclip</b> für 2-Lauf Nutzung, weiß	20 Stück
100751	für 3-Lauf Nutzung, weiß	20 Stück
100752	für 4-Lauf Nutzung, weiß	20 Stück
106115	<b>Zwischen- und Endfeststeller</b> weiß      für Laufbreite 4 und 6 mm	100 Stück
106015	<b>Zwischen- und Endfeststeller</b> transparent      für Laufbreite 6 mm	100 Stück
106011	<b>Zwischen- und Endfeststeller</b> weiß      für Laufbreite 6 mm	100 Stück
106116	<b>Endfeststeller</b> weiß      für Laufbreite 6 mm	100 Stück
104804	<b>X-Gleiter</b> mit Faltenleghaken weiß      für Laufbreite 6 mm	100 Stück
104019	<b>Klick-Gleiter</b> mit Faltenleghaken, an jeder Stelle einklickbar weiß      für Laufbreite 6 mm	100 Stück
104022	weiß, kurzer Haken      für Laufbreite 6 mm	100 Stück
104805	<b>Drehgleiter</b> mit Faltenleghaken, an jeder Stelle ein- und ausdrehbar weiß      für Laufbreite 6 mm	100 Stück

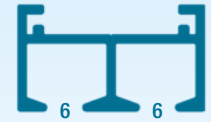
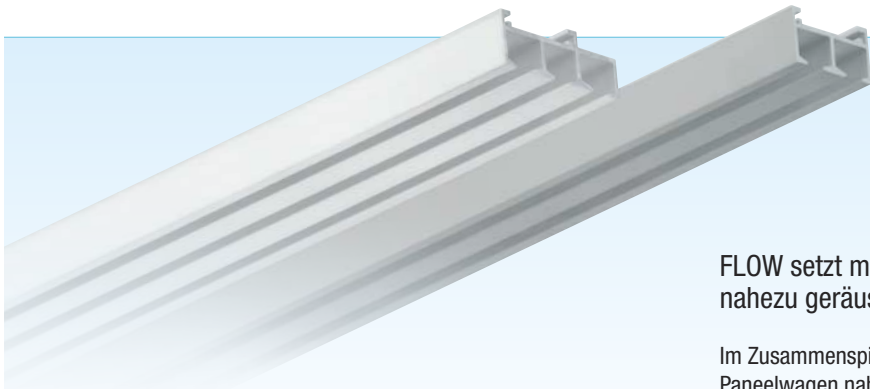

FLOW setzt mit seinen Laufeigenschaften neue Maßstäbe – nahezu geräuschlos

Im Zusammenspiel mit der neu entwickelten FLOW-Rolle gleiten die Paneelwagen nahezu geräuschlos in den Schienen. Selbst schwere Stoffe lassen sich mit einer eleganten Leichtigkeit verschieben. Mit einer Klett- und einer Kedervariante wird FLOW zwei verschiedenen Dekorationsarten gerecht.

Das Flächenvorhangsystem besticht durch sein klares Design. Edel und puristisch – so überzeugt die Produktarchitektur von FLOW.

Der FLOW-Deckenclip ermöglicht maßgeschneiderte Lösungen für jeden Raum. Durch ihn lassen sich die beiden Schienentypen problemlos zu einer vier-, fünf- oder sechsläufigen Schiene kombinieren – raffiniert und leicht zugleich.

## Garnituren



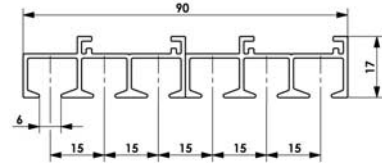
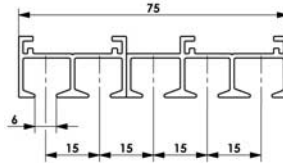
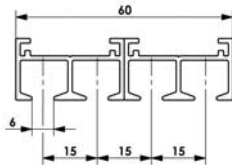
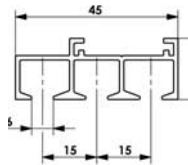
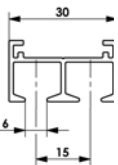



Weiß oder alu matt, mit 2 Enddeckeln und Deckenclips (Anzahl siehe Tabelle)

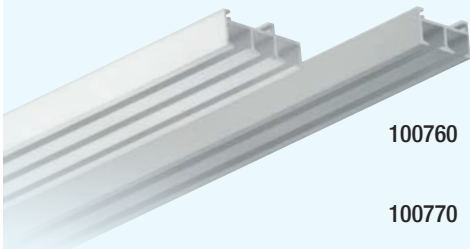
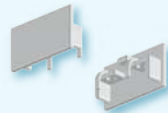
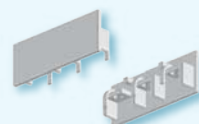

System	2-Lauf	3-Lauf	4-Lauf	5-Lauf	6-Lauf
Art.-Nr. weiß	021920-	021930-	021940-	021950-	021960-
Art.-Nr. alu matt	021921-	021931-	021941-	021951-	021961-

Länge cm	Clip St.	unverb. VK €	unverb. VK €	unverb. VK €	unverb. VK €	unverb. VK €
200	5					
220	5					
240	5					
260	6					
280	6					
300	7					
320	7					
340	7					
360	8					
380	8					
400	9					
420	9					
440	9					
460	10					
480	10					
500	10					
520	11					
540	11					
560	11					
580	12					
600	12					

jede weitere 20 cm

Art.-Nr.	Artikel-Bezeichnung	VE	
			
<b>Flächenvorhangschiene FLOW</b> Befestigung mit Deckenclips, 1 Länge à 6 m, Laufbreite 6 mm			
100760	2-läufig weiß	6 m 30 m	*
100770	alu matt	6 m 30 m	*
100780	3-läufig weiß	6 m 30 m	*
100790	alu matt	6 m 30 m	*
* Verschnitt ist selbst einzukalkulieren.			
<b>Enddeckel</b> für FLOW und FLOW OBJEKT Schienen, bei 4 + 5-läufigen Schienen: 2 Deckel kombinieren			
			
126354	für 2-Lauf weiß	1 Stück	
126355	alu matt	1 Stück	
			
126 356	für 3-Lauf weiß	1 Stück	
126 357	alu matt	1 Stück	
<b>Deckenclip</b> für FLOW Schienen 2 + 3-läufig 100 760 – 100 790,			
			
126358	für 2/3-Lauf weiß	1 Stück	
126359	alu matt	1 Stück	
			
126360	für 4-Lauf zum Kombinieren von 2-Lauf Schienen weiß	1 Stück	
126361	alu matt	1 Stück	
			
126362	für 5/6-Lauf zum Kombinieren von 2- und 3-Lauf Schienen weiß	1 Stück	
126363	alu matt	1 Stück	
<b>Werkzeug</b>			
			
126381	Demontagewerkzeug für Deckenclip	1 Stück	
<b>Objektrolle</b> Extra flache Rollen mit PTFE-Beschichtung.			
			
104809	weiß	für Laufbreite 6 mm	100 Stück

Art.-Nr.

Artikel-Bezeichnung

VE

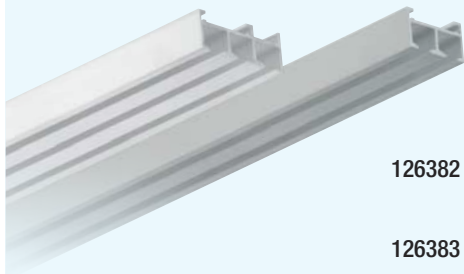

## Flächenvorhangschiene FLOW OBJEKT

Befestigung mit Deckenspanner, ohne Schattenfuge.

1 Länge à 6 m, Laufbreite 6 mm



126382	2-läufig weiß		6 m 30 m	*
126383	alu matt		6 m 30 m	*
126384	3-läufig weiß		6 m 30 m	*
126385	alu matt		6 m 30 m	*
126386	4-läufig weiß		6 m 30 m	*
126387	alu matt		6 m 30 m	*
126388	5-läufig weiß		6 m 30 m	*
126389	alu matt		6 m 30 m	*

\* Verschnitt ist selbst einzukalkulieren.

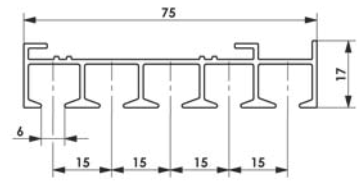
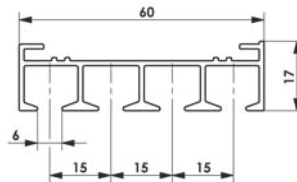
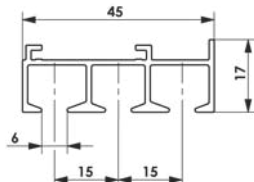
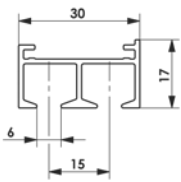

### Enddeckel

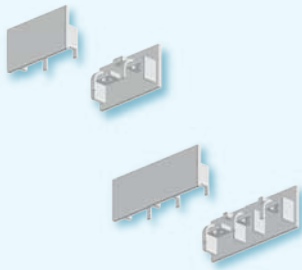
 für FLOW und FLOW OBJEKT Schienen,  
 bei 4 + 5-läufigen Schienen: 2 Deckel kombinieren

126354	für 2-Lauf weiß		1 Stück
126355	alu matt		1 Stück
126356	für 3-Lauf weiß		1 Stück
126357	alu matt		1 Stück

### Deckenspanner / Träger

für FLOW OBJEKT Schienen 126 382 – 126 389, Befestigung ohne Schattenfuge



2002004	für 2- und 3-läufige Schienen	20 Stück
5005001	für 4- und 5-läufige Schienen	20 Stück

### Objektrolle

Extra flache Rollen mit PTFE-Beschichtung.

104809	weiß	für Laufbreite 6 mm		100 Stück
--------	------	---------------------	--	-----------

Art.-Nr.	Artikel-Bezeichnung		VE	
	<b>FLOW Klett-Paneelwagen</b> komplett mit Profil, Rollen, Enddeckeln und Öse			
021970-	weiß	50 cm	1 Stück	
021971-	alu matt	60 cm	1 Stück	
		70 cm	1 Stück	
		80 cm	1 Stück	
		90 cm	1 Stück	
		100 cm	1 Stück	
	jede weitere 10 cm			
	<b>FLOW Keder Paneelwagen</b> komplett mit Profil, Rollen, Enddeckeln und Öse			
021980-	weiß	50 cm	1 Stück	
021981-	alu matt	60 cm	1 Stück	
		70 cm	1 Stück	
		80 cm	1 Stück	
		90 cm	1 Stück	
		100 cm	1 Stück	
	jede weitere 10 cm			
	<b>Einzelteile für FLOW Klett-Paneelwagen</b>			
	<b>Alu-Profil</b> mit Klett-Haftband 31mm hoch, 1 Länge à 3 m		3 m	30 m
126350	weiß			
126351	alu matt			
	* Verschnitt ist selbst einzukalkulieren.			
	<b>Leichtlaufrolle</b> für Klett-Paneelwagen			
126364	weiß		1 Stück	
126365	alu matt		1 Stück	
	<b>Enddeckel</b> für Klett-Paneelwagen			
126374	weiß		1 Stück	
126375	alu matt		1 Stück	
	<b>Einzelteile für FLOW Keder-Paneelwagen</b>			
	<b>Alu-Profil</b> für Keder-Paneelwagen 35 mm hoch, 1 Länge à 3 m		3 m	30 m
126352	weiß			*
126353	alu matt			*
	* Verschnitt ist selbst einzukalkulieren.			
	<b>Leichtlaufrolle</b> für Keder-Paneelwagen			
126366	weiß		1 Stück	
126367	alu matt		1 Stück	
	<b>Enddeckel</b> für Keder-Paneelwagen			
126376	weiß		1 Paar	
126377	alu matt		1 Paar	
	<b>Werkzeug</b>			
126380	Torxschlüssel 6x45 für die Enddeckel der Keder-Paneelwagen		1 Stück	
	<b>Öse für Schleuderstab</b> für FLOW Klett- und Keder-Paneelwagen			
126378	weiß		1 Stück	
126379	alu matt		1 Stück	

# Aluminium-Flächenvorhangschiene

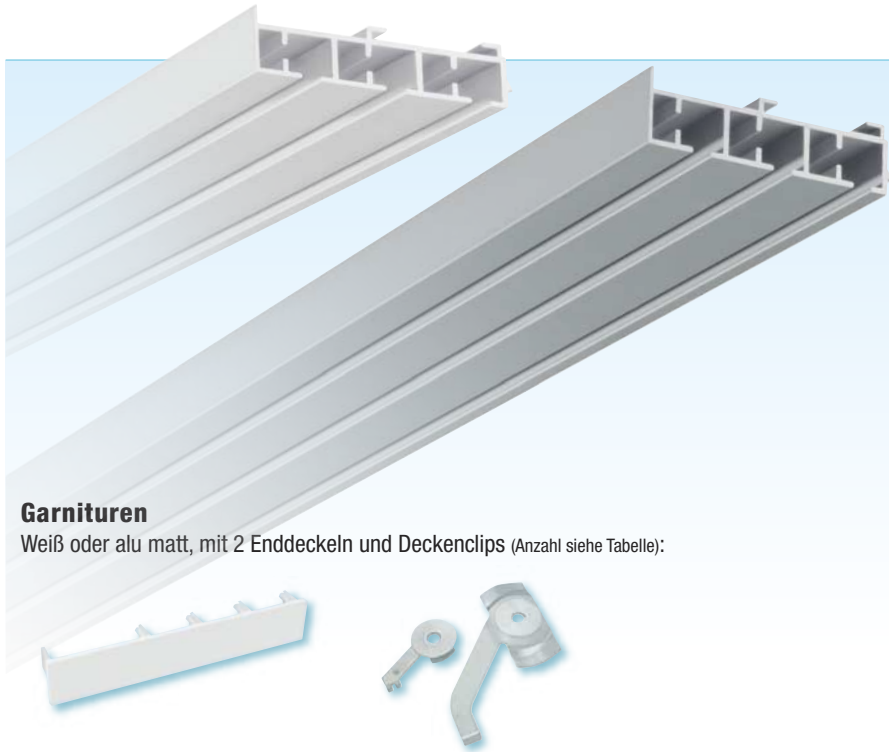

## Garnituren

Weiß oder alu matt, mit 2 Enddeckeln und Deckenclips (Anzahl siehe Tabelle):



Schiene für die Deckenmontage.  
Einsetzbar als Schleuderschiene, Schnurzugsystem und Flächenvorhang-System – Einzelteile auf den folgenden Seiten.

Breite: 38 mm  
Höhe: 17 mm



57 mm  
17 mm



76 mm  
16,5 mm



95 mm  
16,5 mm



### System

Art.-Nr. weiß  
Art.-Nr. alu matt

### 2-Lauf

2002...  
2012...

### 3-Lauf

3003...  
3013...

### 4-Lauf

4004...  
4014...

### 5-Lauf

5005...  
5015...

Länge cm	2-Lauf		3-Lauf		4-Lauf		5-Lauf	
	Träger	unverb. VK €	Träger	unverb. VK €	Träger	unverb. VK €	Träger	unverb. VK €
100	3		3		3		3	
120	3		3		3		3	
140	3		3		3		3	
160	4		4		4		4	
180	4		4		4		4	
200	5		5		5		5	
220	5		5		5		5	
240	5		5		5		5	
260	6		6		6		6	
280	6		6		6		6	
300	7		7		7		7	
320	7		7		7		7	
340	7		7		7		7	
360	8		8		8		8	
380	8		8		8		8	
400	9		9		9		9	
420	9		9		9		9	
440	9		9		9		9	
460	10		10		10		10	
480	10		10		10		10	
500	11		11		11		11	
520	11		11		11		11	
540	11		11		11		11	
560	12		12		12		12	
580	12		12		12		12	
600	13		13		13		13	

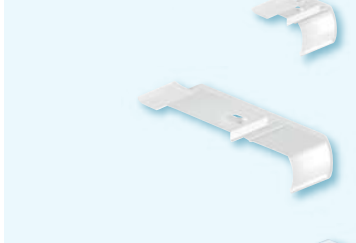
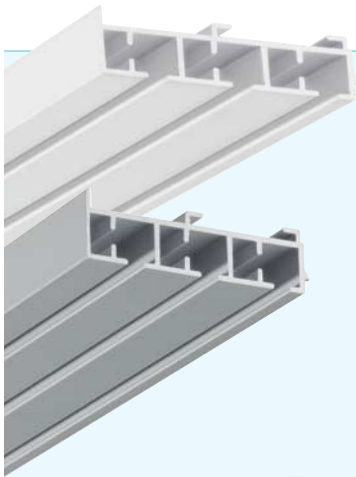

Art.-Nr.	Artikel-Bezeichnung	VE
	<b>Flächenvorhangschiene</b> , 1 Länge à 6 m, Laufbreite 4 mm	6 m 30 m
	<b>2-läufig</b>	
2002000 AV	weiß	
2002010 AV	alu matt	
	<b>3-läufig</b>	
3003000 AV	weiß	
3003010 AV	alu matt	
	<b>4-läufig</b>	
4004000 AV	weiß	
4004010 AV	alu matt	
	<b>5-läufig</b>	
5005000 AV	weiß	
5005010 AV	alu matt	
	* Verschnitt ist selbst einzukalkulieren.	
	<b>Enddeckel 2- bis 5-läufig</b> , Kunststoff, kürzbar	
2002002	weiß	
2002003	alu matt	
		10 Stück
		10 Stück
1001001	<b>Profilverbinder</b>	100 Stück
	<b>Deckenspanner / Träger</b>	
2002004	für 2- und 3-läufige Schienen	20 Stück
5005001	für 4- und 5-läufige Schienen	20 Stück
	<b>Deckenclip</b>	
	für 2-läufige Schienen	
	2002011 weiß   2002012 alu matt	20 Stück
	für 3-läufige Schienen	
	2002013 weiß   2002014 alu matt	20 Stück
	für 4-läufige Schienen	
	5005011 weiß   5005012 alu matt	20 Stück
	für 5-läufige Schienen	
	5005013 weiß   5005014 alu matt	20 Stück
	<b>Winkelträger</b> , extra stabil, Langloch, mit Nutstein (für Deckenspanner 2002004 + 5005001)	
	12 cm lang	
	126112 weiß   126212 alu matt	10 Stück
	16 cm lang	
	126116 weiß   126216 alu matt	10 Stück
	<b>Wandträger</b> kurz, WA 6,5 bis 12,5 cm	1 Stück
	788740 weiß   788750 alu matt   788760 schwarz	
	<b>Wandträger</b> lang, WA 6,5 bis 18,5 cm	1 Stück
	788741 weiß   788751 alu matt   788761 schwarz	
	<b>Wandträger</b> »Discreet« – kurz, 10 cm	1 Stück
	100551 weiß matt   100552 schwarz   100553 scotch bright	
	<b>Wandträger</b> »Discreet« – lang, 15 cm	1 Stück
	100554 weiß matt   100555 schwarz   100556 scotch bright	
106012	<b>Zwischen- und Endfeststeller</b>	weiß Laufbreite 4 mm 100 Stück
106117	<b>Endfeststeller</b>	weiß Laufbreite 4 mm 100 Stück
104904	<b>X-Gleiter</b> mit Faltenleghaken	weiß Laufbreite 4 mm 100 Stück
104018	<b>Click-Gleiter</b> mit Haken lang	weiß Laufbreite 4 mm 100 Stück
104021	<b>Click-Gleiter</b> mit Haken kurz	weiß Laufbreite 4 mm 100 Stück













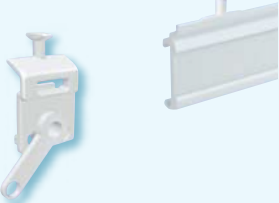
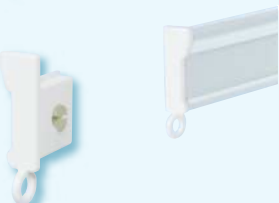

Art.-Nr.	Artikel-Bezeichnung	VE	
			
<b>Flächenvorhang-Keilprofil</b> Kunststoffprofil mit Klett-Haftband, weiß			
126061	1 Länge à 2 m	2 m 10 m 20 m 60 m	*
126061-1	1 Länge à 6 m <small>* Verschnitt ist selbst einzukalkulieren.</small>	60 m	
			
<b>Profilverbinder</b>			
126068	weiß	1 Stück 100 Stück	
			
<b>Abschluss-Seitendeckel</b>			
126062	für Flächenvorhang-Keilprofil, weiß	1 Paar 50 Paar	
			
<b>Schienen-Schwenkrolle</b>			
126063	Bohrung: 5 mm ø, weiß, für 4 mm Läufe	1 Stück 100 Stück	
126 063-2	Grundkörper ohne X-Gleiter		
126063-3	<b>X-Gleiter</b> als Ersatzteil, zum Einclippen in Grundkörper, weiß, für 6 mm Läufe	1 Stück 100 Stück	
126069	Schleuderstabhalter mit Öse für Flächenvorhang-Keilprofil		
			
<b>Paneltechnik Set »Alu-Acryl«</b> Alu-Paneelwagen mit Klettband + Acryl-Beschwerungsstab, rund			
<ul style="list-style-type: none"> <li>• X-Gleiter für 6 mm Alu-Lauf und Rollen für 4 mm Kunststoff-Lauf</li> <li>• Länge 60 cm</li> <li>• Endkappen mit Mitnehmern</li> </ul>			
698850	Paneelwagen alu matt, Beschwerung transparent	1 Set	
698851	Paneelwagen weiß, Beschwerung transparent	1 Set	
			
<b>Paneltechnik Set »Alu rund«</b> Paneelwagen + Beschwerungsleiste klappbar zum Festklemmen der Stoffbahn.			
<ul style="list-style-type: none"> <li>• integrierter Klebesteifen zur zusätzlichen Fixierung</li> <li>• Gleiter für 6 mm Alu-Lauf</li> <li>• Länge 60 cm</li> <li>• Endkappen</li> </ul>			
698852	Paneelwagen + Beschwerung alu matt	1 Set	
698854	Paneelwagen + Beschwerung weiß	1 Set	

# Flächenvorhangsysteme



unverb. VK  
€ (inkl. MwSt.)

Art.-Nr.	Artikel-Bezeichnung	VE	
			
	<b>Flächenvorhang-Paneel</b> Alu-Profil und spezielle Clipsgleiter für viele Schienen zum Kombinieren.		
126033	<b>Alu-Profil</b> mit Klett-Haftband, weiß * Verschnitt ist selbst einzukalkulieren.	3 m	*
			
	<b>Clipsgleiter</b>		
126034	für ED Wendeschiene, weiß (auch für 16 + 20 mm Ø Profile geeignet)	100 Stück	
			
	<b>Clipsgleiter</b>		
126034-4	für alle Alu- und Kunststoffschienen mit 4 bis 6 mm Läufen, weiß, (außer Schleuderschiene 100620/630)	100 Stück	
			
	<b>Endkappen mit Öse</b>		
126034-5	weiß	100 Paar	
			
	<b>Endkappen</b>		
126034-6	weiß	100 Paar	
			
	<b>Mitnehmer</b>		
126034-7	weiß (nur mit Clipsgleiter 126034-4 verwendbar)	100 Stück	
			
	<b>Kunststoff-Beschwerungsstab</b> , rund		
100105	10 mm Ø, transparent	1 Länge à 1,43 m	10 Stück
100105-1	10 mm Ø, transparent	1 Länge à 6,00 m	50 Stück 10 Stück
			
	<b>Aluminium-Beschwerungsstab</b> 25 x 3 mm		
100102	weiß	1 Länge à 2,65 m	2,65 m
100102-1	weiß	1 Länge à 6,00 m	6,00 m 
	* Verschnitt ist selbst einzukalkulieren.		*
			
	<b>Klett-Flauschband 20 mm breit</b>		
113503	weiß, Flauschband einzeln, aufnähbar	25 m	
<p>Weitere Beschwerungs-systeme finden Sie auf Seite <b>D 363 + 364</b>, weitere <b>Klett-Flauschbänder</b> auf Seite <b>D 420</b>.</p>			
			
<p>ED Flächenvorhang-Systeme für alle aktuellen Vorhangschienen, wie Alu- und SM-Schienen. Die Kunststoffprofile lassen sich durch einklipsbare Schwenkrollen auch nachträglich montieren. Unsere Alupaneele zeichnen sich ebenfalls durch die leichte Montage aus und verfügen zudem über hervorragende Gleiteigenschaften – die Paneele laufen besonders leise.</p>			

Art.-Nr.	Artikel-Bezeichnung	VE
		
	<b>Aluprofil / Pilzstab</b> mit Klett-Haftband 15 mm breit, weiß, (ohne Endkappe)	
143146	1 Länge à 2,50 m	25 m
		50 m
143146-1	1 Länge à 5,00 m * Verschnitt ist selbst einzukalkulieren.	100 m
		
	<b>Endkappe</b> weiß	
143154		50 Stück
		
	<b>Verbinder</b> weiß	
143155		20 Stück
		
	<b>Fensterclip</b> zum Einclippen des Pilzstabes und anschließendem Ankleben an Fensterflügel	
144082	weiß	Flügelstärke max. 22 mm 10 Stück
144083	weiß, mit <i>Easy-Click</i> Technik	Flügelstärke max. 20 mm 10 Stück
		
	<b>Wandclip</b> zur direkten Befestigung des Pilzstabes an der Wand	
144096	weiß	20 Stück
144097	weiß, mit <i>Easy-Click</i> Technik	20 Stück
		
	<b>Deckenclip</b> zur direkten Befestigung des Pilzstabes an der Decke	
150698	weiß	20 Stück
		
	<b>Schnurstopp</b> für ein Faltrollo-System Passend auf Pilzstab, inklusive Adapter zum Ein- und Ausclippen. weiß, 50 x 14 mm	
144091	rechts	10 Stück
144092	links	10 Stück
		
	<b>Schnurschloss</b> Universal	
126075	weiß	10 Stück
		
	<b>Schiebevorhanggleiter</b> für Flächenvorhang-Systeme Passend auf Pilzstab.	
	Für Alu-Vorhangschienen 4 mm, APS und SM-Plus	
144093	weiß	20 Stück
144095	weiß, mit <i>Easy-Click</i> Technik	20 Stück 
	Für Alu-Vorhangschienen 6 mm	
144094	weiß	20 Stück
144098	weiß, mit <i>Easy-Click</i> Technik	20 Stück 
		
	<b>Rollo-Taschen-Band</b> für die Schnurzugführung bei Raffrollos Beschichtet, integriertes Flauschband zum Aufbügeln, mit Taschen zum Einschieben der Zugschnur-Öse. Beim Waschen verbleiben die Zugschnüre und die Zugschnur-Ösen einfach im Rollo.	
112057	weiß, 37 mm breit	25 m 
112058	weiß, 55 mm breit	25 m
	<b>Zugschnur-Öse</b>	
112060	weiß, für Rollo-Taschen-Band 37 mm	50 Stück 
112061	weiß, für Rollo-Taschen-Band 55 mm	50 Stück



Easy-Click Technik

Art.-Nr.	Artikel-Bezeichnung	VE
126065	<b>Plexiglas Flachstab</b> 25 x 3 mm, transparent	1 Länge à 1,50 m 10 Stück 20 Stück
	<b>Klett-Haftband</b> selbstklebend 20 mm breit, weiß	25 m 
126140	<b>Paneelclip</b> für Flachstäbe 25 x 3 mm	100 Stück
126141	<b>Paneelmitnehmer</b> für Flachstäbe 25 x 3 mm	100 Stück
126142	<b>Ösengleiter</b> für Innenlaufschienen 4 bis 6 mm Laufbreite	100 Stück
126143	<b>Ösenrolle</b> 8 mm Ø für Innenlaufschienen	100 Stück
126144	<b>X-Gleiter</b> für Aluschienen 6 mm Laufbreite	100 Stück
126150	<b>Schnurschloss</b> für Rafftechnik	10 Stück
112022	<b>S-Haken</b> weiß	100 Stück
112025	<b>S-Haken</b> klar	100 Stück
126151	<b>Decken- und Wandträger</b> Wandabstand mit Paneelclip: 35 mm	10 Stück
126153	<b>Klemmträger</b> für Fensterbefestigung VE = 2 Stück	1 VE 10 VE



- ED Flächenvorhang und Rafftechnik mit vielfältigen Einsatzmöglichkeiten:
- Mit Gleitern für alle aktuellen Vorhangschienen, wie SM-Schienen, Alu-Schienen usw.
  - Mit Trägern für Wand- und Deckenmontage
  - Mit Klemmträgern für Fenster
  - Mit Schnurschloss auch als Raffvorhangtechnik einsetzbar



302 856  
302 857  
302 858

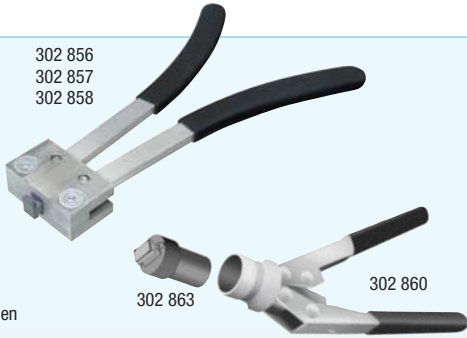

## Ausklinkzange

für Innenlauf-Gardinenschiene

Art.-Nr.	Ausführung
302856	für Kunststoff-Schiene Vierkantloch, Lochmaß: ca. 10,5 x 12 mm
302857	für Alu-Schiene für 6 mm Laufbreite, Lochmaß: ca. 8,5 x 10,5 mm
302858	für 4 mm Laufbreite, Lochmaß: ca. 6,0 x 10,5 mm
302860	für Alu-Schiene Ausklinkzange, ohne Stanzkopf
302863	Stanzkopf, für 5,2 – 6,6 mm Läufe, ca. 10 x 16 mm Weitere Stanzköpfe, auch zum nachträglichen Ausklinken, auf Anfrage!
302868	Koffer für Ausklinkzange und Stanzkopf

## Hand-Biegegerät

für ED Aluschiene

Art.-Nr.	Ausführung
107100	ohne Scheibe, inkl. Andrückrollen für ED »Schleuder- und Bilderschiene«
107100-14	Scheibe (Radius 6,5 cm) für ED »Rund« 4 mm
107100-5	für ED »Rund« 6 mm
107100-15	für ED »High«
107100-6	für ED »Maxi«
107100-13	für ED »Straight«
107100-9	für ED »Schleuder- und Bilderschiene«
107100-7	Andrückrollen für ED »Rund« 4 mm / »Rund« 6 mm / »Maxi« / »Straight«
107100-28	für ED »High«

## Tisch-Biegegerät

für ED Aluschiene

Art.-Nr.	Ausführung
107101	ohne Scheibensatz (Scheibe und Andrückrollen)
107101-4	Scheibensatz (Radius 10 cm) für ED Aluschiene »Rund« 6 mm + »Maxi«
107101-5	für »ED Schleuder- und Bilderschiene«
107101-8	für »ED Wendeschiene 1+2-Lauf« + »High«

## Biegeeinlagen (Keder)

für ED Aluschiene; Macrolon, 100 cm lang

Art.-Nr.	Ausführung
107100-25	Laufkanal-Biegeeinlage für »Rund« 4 mm
107100-26	Aufsteckkanal-Biegeeinlage für »Rund« 4 mm
107100-1	Laufkanal-Biegeeinlage für »Rund« 6 mm
107100-2	Aufsteckkanal-Biegeeinlage für »Rund« 6 mm + »High«
107100-3	Laufkanal-Biegeeinlage für »Maxi« + »High«
107100-27	Laufkanal-Biegeeinlage für »Straight«
100546	Laufkanal-Biegeeinlage für »High« (2 werden benötigt)
107100-20	Träger + Laufkanal-Biegeeinlage für »ED Schleuder- und Bilderschiene« 4,0 x 5,3 mm
107100-21	6,4 x 5,5 mm
107100-22	7,5 x 6,2 mm
107100-30	Laufkanal-Biegeeinlage für »ED Wendeschiene 1+2-Lauf«

## Ausklinkung

Wir klinken für Sie aus.

Bitte angeben: rechts und / oder links / Lauf



### Ausklinkung

Art.-Nr.

001015 Ausklinkung, per Stück

## Bohrung / Senkung

Wir bohren Ihre Schiene für Sie vor.

Bitte angeben: erstes und letztes Loch, Anzahl, Abstand, Durchmesser, Seitenverwendung der Schiene.



### Vorbohren / Senken

Art.-Nr.

001016 Bohrung/Senkung, per Stück

## Biegung

Wir biegen für Sie – die Biegemöglichkeiten finden Sie bei den Profilen.

Bitte senden Sie uns präzise und vollständige Maßangaben oder eine Schablone unter Angabe Ihrer Sichtweise – Ihre Skizzen werden ansonsten als Draufsicht umgesetzt.

Maßtoleranzen von +/- 1 cm.

Schenkellänge 1  
Schenkellänge 2  
oder Schablone 1:1

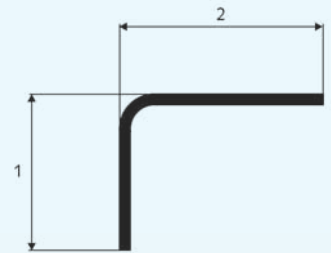

### Biegung 90°

Art.-Nr.

001010  
001010-1 für »ED Wendeschiene 1+2-läufig«

Schenkellänge 1  
Schenkellänge 2  
Winkel  
oder Schablone 1:1

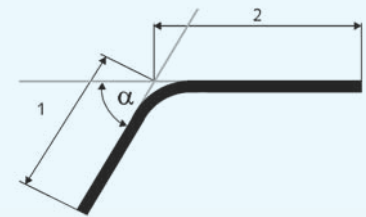

### Biegung 0° bis 90°

Art.-Nr.

001011  
001011-1 für »ED Wendeschiene 1+2-läufig«

Nur Schablone 1:1

### Biegung Erker

Art.-Nr.

001012

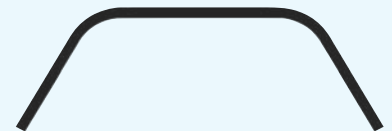

Breite 1  
Tiefe 2  
oder Schablone 1:1

### Biegung Segment

Art.-Nr.

001013

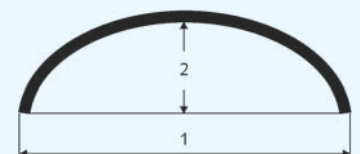



SM-Innenlaufschiene

ab Seite D 330



T-Schiene + Zubehör

Seite D 332

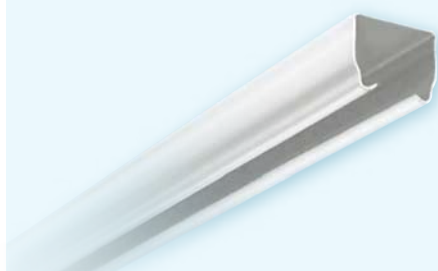

U-Schiene + Zubehör

ab Seite D 333



Schwerstegschiene | Objektschiene

ab Seite D 335









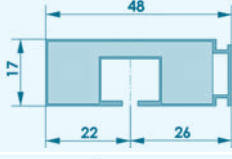
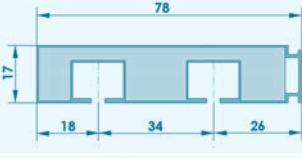
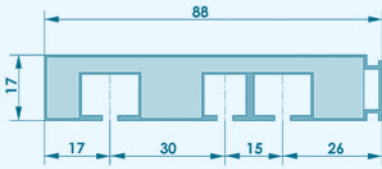

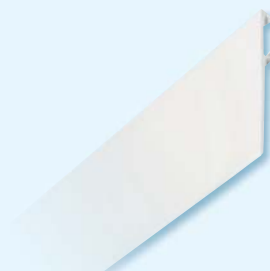
Wandbespannung | Raumakustik | Wollfriesvorhang

ab Seite D 336

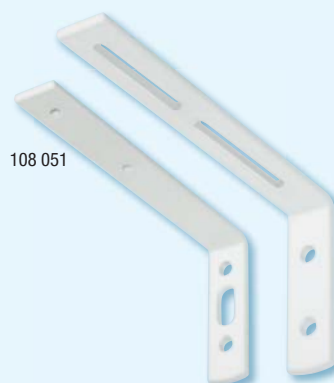
# SM-Innenlaufschiene

Art.-Nr.	Artikel-Bezeichnung	VE
		
<b>SM-Innenlaufschiene</b> Kunststoffmantel mit MDF-Kern, mit Nase für Aufsteckblende, 4 mm Laufbreite <span style="float: right;">1 Länge à 6 m</span>		
100031	SM 1 Plus einläufig weiß	 6 m 30 m
100033	SM 2 Plus zweiläufig weiß	 6 m 30 m
100035	SM 3 Plus dreiläufig weiß	 6 m 30 m
* Verschnitt ist selbst einzukalkulieren.		
<b>Retourenpaar, rund, teilbar</b> anpassbar für alle SM Plus Innenlaufschiene		
101010	weiß	Abmessung: 60 x 400 mm <span style="float: right;">10 Stück</span>
<b>Erkeraußenbogen, teilbar</b> weiß		
102351	SM 1 Plus	Abmessung: 130 x 130 mm <span style="float: right;">20 Stück</span>
102352	SM 2 Plus	Abmessung: 150 x 150 mm <span style="float: right;">20 Stück</span>
102353	SM 3 Plus	Abmessung: 150 x 150 mm <span style="float: right;">20 Stück</span>
<b>Erkerinnenbogen, teilbar</b> weiß		
102371	SM 1 Plus	Abmessung: 130 x 130 mm <span style="float: right;">20 Stück</span>
102372	SM 2 Plus	Abmessung: 150 x 150 mm <span style="float: right;">20 Stück</span>
102373	SM 3 Plus	Abmessung: 160 x 160 mm <span style="float: right;">20 Stück</span>
<b>Adapter für teilbare Innen- und Aussenbögen</b> weiß		
102381 AV	SM 1 Plus	10 Stück
102383 AV	SM 3 Plus	10 Stück
<b>Rundbogenpaar</b> weiß		
102252	SM 2 Plus	Abmessung: 150 x 150 mm <span style="float: right;">10 Paar</span>
102254	SM 3 Plus	Abmessung: 150 x 150 mm <span style="float: right;">10 Paar</span>
<b>Seitendeckel</b> für alle SM Plus Innenlaufschiene, kürzbar		
130451	weiß	50 Paar

Art.-Nr.	Artikel-Bezeichnung	VE
		
	<b>Aufsteckblende für SM Plus</b> Kunststoff, 50 mm breit	
103001	weiß  * Verschnitt ist selbst einzukalkulieren.	50 m
		
	<b>Verbindungszapfen für SM Plus</b>	
130450	transparent	100 Stück
		
	<b>Abdeckstopfen für SM Plus</b>	
106055	weiß	1.000 Stück 
		
	<b>Klipp-Klapp-Klammern</b>	
130045	breite Ausführung	100 Stück
130050	selbstklebend	100 Stück
		
	<b>Winkeleisen, gelocht</b> weiß	
108051 AV	100 mm lang	10 Paar
108052	120 mm lang	10 Paar
108053	160 mm lang	10 Paar
		
	<b>Brettklemmen</b>	
108050	glanzverzinkt	10 Paar
108070	weiß	10 Paar
		
	<b>Metallwinkel, 2 mm stark</b>	
	<b>Stuhlwinkel Eisen verzinkt</b>	
108023	25 x 25 mm, 14 mm breit	100 Stück
108024	30 x 30 mm, 14 mm breit	100 Stück
	<b>Breitwinkel Eisen</b>	
108025	30 x 30 mm, 30 mm breit	100 Stück
108026	40 x 40 mm, 30 mm breit	100 Stück
		
	<b>Rollen und Gleiter</b>	104 ... + 107 ...
	<b>Feststeller</b>	106 ...
	<b>Stufenbohrer</b>	312 200 + 312 201
	<b>Hand-Lochfräser</b>	326 536
	<b>Gleitsprays</b>	130 001/002 + 123 121
	finden Sie ab Seite D 340	finden Sie ab Seite D 344
	finden Sie in unserem Werkzeugkatalog	finden Sie auf Seite D 345
	finden Sie auf Seite D 345	finden Sie auf Seite D 345
		



# T-Schiene + Zubehör



Art.-Nr.	Artikel-Bezeichnung	VE
	<b>Kunststoff-T-Schiene, gelocht</b> 1 Länge à 5 m	
100150	weiß	5 m 50 m 250 m

\* Verschnitt ist selbst einzukalkulieren.



	<b>T-Rollen</b>	
104025	Messingrollen und Messingbügel, vernickelt	100 Stück 



	<b>T-Rollen</b>	
104026	Kunststoffrollen und Metallbügel, vernickelt	100 Stück 



	<b>T-Rollen</b>	
104027	Kunststoffrollen und Kunststoffbügel	100 Stück 



	<b>T-Rollen</b>	
104028	Kunststoff, mit Faltenleghaken	100 Stück 



	<b>T-Rollen</b>	
104029	mit Klammer, Metall vernickelt und Kunststoffrollen	100 Stück 



	<b>T-Laufrollenklammern</b>	
130025	Metall, vernickelt	100 Stück 



	<b>T-Gleiter</b>	
107030	Kunststoff	100 Stück 



	<b>T-Feststeller</b>	
106030	Kunststoff	100 Stück 



	<b>Universal-Feststeller</b>	
104159	Kunststoff, für T- und U-Schiene	100 Stück 



Art.-Nr. Artikel-Bezeichnung VE

## U-Schienen

1 Länge à 6 m

100200 hochwertige Ausführung, weiß lackiert 6 m  
60 m

\* Verschnitt ist selbst einzukalkulieren.

## U-Laufrollen

104100 mit Metallhaken weiß lackiert und Kunststoffrollen weiß 100 Stück

104103 mit Metallhaken vernickelt und Kunststoffrollen weiß 100 Stück

## U-Laufrollen

104101 mit Kunststoffsteckhaken, Kunststoffrollen und 12 mm breiter Messingachse, weiß 100 Stück

## U-Laufrollen, Kunststoff

104013 mit Faltenleghaken 100 Stück

104016 mit Faltenleghaken 100 Stück

104016-1 mit Faltenleghaken und 12 mm breiter Messingachse 100 Stück

104016-2 mit kleiner Öse und 12 mm breiter Messingachse 100 Stück

104016-3 mit großer Öse und 12 mm breiter Messingachse 100 Stück

107045 Faltenleghaken für Laufrollen mit Öse 100 Stück

## U-Laufrollen

104102 mit Metallklammer und Kunststoffrollen, weiß 100 Stück

## U-Schleuderwagen

104150 mit Metallhaken vernickelt und Kunststoffrollen weiß 100 Stück

## U-Überzugwagen

104151 mit Metallhaken und Kunststoffrollen, weiß lackiert 10 Paar

## U-Zuggarnituren

104152 weiß lackiert 10 Paar

## U-Feststeller

Metall, mit Schnur-Führungs-Öse

104153 weiß lackiert 100 Stück

106021 verzinkt 100 Stück

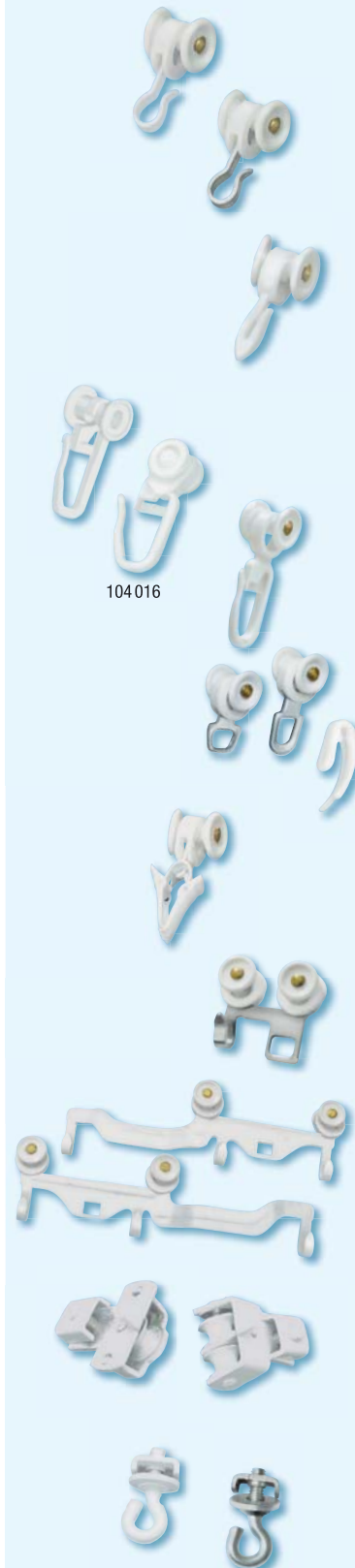

104016

# U-Schiene + Zubehör

Art.-Nr. Artikel-Bezeichnung VE

## U-Seitenlager



104160 Metall, weiß lackiert 10 Paar

## U-Deckenhalter



104162 Metall, weiß lackiert 25 Paar

## U-Übergreifer



104171 Metall, weiß lackiert 10 Paar

## U-Träger



104172 Metall, weiß lackiert 10 Paar  
(Passend dazu U-Verbinder 104181-1)

## U-Bogenstück



104176 90°, weiß lackiert, mit Verbinder 10 Stück

## U-Verbinder



104181-1 Metall, weiß 10 Stück

104181 Kunststoff, transparent 25 Stück

## U-Schienehalter, verstellbar zum Befestigen einer U-Storeschiene an Vorhanggarnituren, für Trägerstärken 12 – 20 mm Ø



509120 weiß  10 Stück

509128 nickel  10 Stück

509124 glasklar  10 Stück

509135 wasserklar,  10 Stück  
für SZ- und Stilträger 15,0 – 29,5 mm Ø

Schienehalter für Alu-Profile 20 mm + 28 mm Ø auf Seite D 377a.

## U-Endkappe



509130 weiß  10 Stück







509133 nickel  10 Stück

509134 glasklar  10 Stück

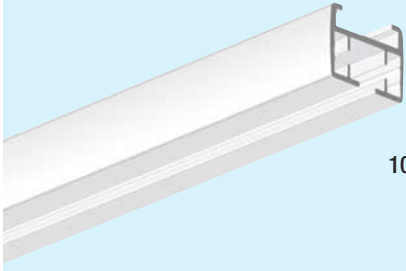
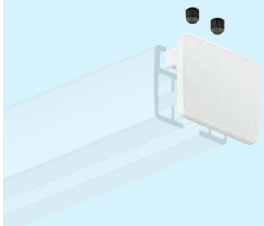
# Schwerstegschiene + Zubehör

	Art.-Nr.	Artikel-Bezeichnung	VE
		<b>Schwerstegschiene</b> ungelocht, Abmessung: 25 x 25 mm	
	608113 AV	Aluminium, schwarz 	6 m Länge Zuschnitt
		<b>Verbindungshülse</b> zum Verbinden der Schwerstegschiene	
	605351	Stahl	1 Stück 10 Stück
		<b>Decken-Clip</b>	
	608271	Metall	1 Stück 10 Stück
 70 mm 55 mm		<b>Roller mit Wirbel</b>	
	608125	Kunststoff, schwarz / Metall	1 Stück 20 Stück 100 Stück
 40 mm 25 mm		<b>Roller mit Auge</b>	
	608130	Kunststoff, schwarz	1 Stück 20 Stück 100 Stück
 43 mm 11 mm		<b>Rollerhaken</b>	
	608150	Stahl vernickelt	1 Stück 20 Stück 100 Stück
		<b>Feststeller</b>	
	608140	Aluminium	1 Stück
		<b>Schwerstegband</b> Polyester, 30 mm breit	
	112255 112255-1	weiß  schwarz 	 Rolle 100 m Rolle 100 m

# Objektschiene

Art.-Nr.	Artikel-Bezeichnung	VE
	<b>Objektschiene</b> Aluminium, pulverbeschichtet, Biegeradius 30 cm, Abmessung (BxH): 31 x 26 mm, Laufbreite: 6,4 mm	
100800	weiß, RAL 9016	6 m Länge Zuschnitt
	<b>Endkappe</b>	
100802	weiß	1 Stück
	<b>Profilverbinder</b>	
100806	Metall	1 Stück
	<b>Deckenspannriegel</b>	
100801	Metall	1 Stück 10 Stück
	<b>Vorhangrolle</b> Kunststoff, mit Stahlachse	
100803	weiß	1 Stück 100 Stück
	<b>Metallhaken</b> für Vorhangrolle	
100804	Metall	1 Stück 100 Stück
	<b>Vorhangrolle</b> Kunststoff, mit drehbarer Öse	
100805	weiß	1 Stück 100 Stück
	<b>Zwischenfeststeller</b>	
106018	Metall + Kunststoff	100 Stück



Art.-Nr.

Artikel-Bezeichnung

VE



Fotos: ADO Goldkante

Wandbespannungen für den gesamten Raum oder als Akzent an einzelnen Wänden wirken sich positiv auf die Raumtemperatur und -akustik aus.

- Unebene Wände werden begradigt
- Optimale Schalldämmung, auch im Heimkino
- Kabel können hinter dem Stoff verlegt werden
- Stoffe können zur Reinigung abgenommen werden
- Räume werden wohnlicher und eleganter
- Wärmedämmende Wirkung

SYSTEM 1



### Wandbespannungsleiste / Universalprofil mit Klebeschicht für Dämmmaterial

533130 130 cm lang, weiß, Kunststoff 1 Stück



### Klebeleiste / Keder für den Stoff, zur Verwendung mit 533 130

533100 100 cm lang, transparent, Kunststoff 1 Stück

SYSTEM 2



### Wandbespannungsleiste ohne Profilkante für eine vollflächige Wandbespannung und ebene Anschlagseiten

533160 250 cm lang, weiß, Kunststoff 1 Stück



### Wandbespannungsleiste mit Profilkante für eine partielle Wandbespannung und unebene Anschlagseiten

533150 250 cm lang, weiß, Kunststoff 1 Stück



### Spachtel zum Eindrücken des Stoffes in die Profilleiste

533170 Kunststoffspachtel 1 Stück

533180 Edelstahlspachtel 1 Stück

Art.-Nr.	Artikel-Bezeichnung	VE
	<b>Polyester-Watte</b> , weiß, thermisch verfestigt, flammhemmend nach British Standard 5852 Schedule 2 part 1,  California Norm Bulletin 117 und FMVSS 302, schadstoffgeprüft nach <b>OEKO-TEX® STANDARD 100</b>	
	203010 100 g/m <sup>2</sup> , 140 cm breit, Rolle 40 m = 56 m <sup>2</sup>	1 Rolle
206134	<b>Molton</b> , rohweiß/ecru, 2-seitig geraucht, flammhemmend nach DIN 4102 B1  300 g/m <sup>2</sup> , 300 cm breit, Rolle ca. 30 m	1 Rolle
	<b>Akustik-Schaum</b> Schaumstoff zur Schall- und Wärmeisolierung, flammhemmend nach DIN 4102 B1 	
	205262 2 cm stark, Platte ca. 100 x 50 cm = 0,5 m <sup>2</sup> 205263 3 cm stark, Platte ca. 100 x 50 cm = 0,5 m <sup>2</sup> Weitere Stärken lieferbar.	15 Platten 15 Platten
	<b>ED Akustik-Noppenplatte Basotect</b> Plattengröße ca. 100 x 50 cm = 0,5 m <sup>2</sup> ,  flammhemmend nach DIN 4102 B1	
	205273 3 cm stark hellgrau 205275 4 cm stark hellgrau	1 Platte 1 Platte
	<b>Akustik-Stoff ACUSTICA</b> Strukturgewebe zur Schallabsorption Bewerteter Schallabsorptionsgrad $\alpha_w = 0,20$ / Schallabsorberklasse: E 217 g/m <sup>2</sup> , champagner-weiß, Material: 100 % Polyester Trevira CS flammhemmend nach DIN 4102 B1 	
	206175 60 cm breit, Rolle ca. 30 m 206176 140 cm breit, Rolle ca. 30 m	1 Rolle 1 Rolle
	<b>Akustik-Watte</b> zur Schallabsorption, z.B. für Akustikpaneele und Trennwände, auch zur Wärmedämmung einsetzbar. Bewerteter Schallabsorptionsgrad $\alpha_w = 0,70$ / Schallabsorberklasse: C 300 g/m <sup>2</sup> , ca. 10 mm stark schadstoffgeprüft nach <b>OEKO-TEX® STANDARD 100</b>	
	203040 100 cm breit, Rolle ca. 80 m 01159 Handmuster DIN A4 Akustikwatte 203040	1 Rolle
	<b>Klett-Scheiben</b> mit Loch zur Befestigung von Akustikelementen.	
	113545 45 mm Ø, 3 mm stark, Haken-Scheibe weiß – Flusch schwarz	20 Stück 100 Stück 1000 Stück

Unsere **Wollfries-Vorhänge**, **Filze** (nächste Seite) und **Schaumstoffe** (P.54) verbessern ebenfalls die Qualität der Akustik.

	<b>Unterfütterung für Steckdosen</b> zum Höhenausgleich 10 mm stark, Holz	1 Stück
	<b>Stahlnägel</b> , blau, 2,5 x 40 mm	1.000 Stück 
	<b>Spezial-Spanplattenschrauben</b> , kleiner Senkkopf 3,0 x 30 mm, Vollgewinde	200 Stück 
	3,0 x 40 mm, Vollgewinde	200 Stück 
	<b>2-K Dübel DUOPOWER</b> (Fischer) 5 mm Ø	100 Stück 
	<b>ED - Quadro-Dübel</b> gelb, 5 mm Ø	500 Stück  1.000 Stück 



Art.-Nr.

Artikel-Bezeichnung

VE



### Thermovorhänge für Türen und Fenster

Im Eingangsbereich von Gastronomiebetrieben und Wohnungen bieten Wollfriesvorhänge einen optimalen Schutz vor Zugluft und Kälte.

Auch zur Abtrennung von Durchgängen, Fluren und Räumen, sowie als Kälteschutzvorhang für Fenster kommen sie zum Einsatz.

Wollfriesvorhänge senken die Energiekosten, nehmen überschüssige Luftfeuchtigkeit auf und verbessern die Raumakustik (Schalldämmung).



### Wollfries

ca. 150 cm breit, ca. 1.000 g/lfm, 100% Schurwolle

1 m  
3 m  
5 m  
15 m  
25 m

#### Farben:

	208 110 beige		208 116 gelb		208 122 wollweiß
	208 111 hellbeige		208 117 terra		208 123 hellgrau
	208 112 camel		208 118 rot		208 129 dust grey
	208 113 braun		208 119 weinrot		208 125 anthrazit
	208 114 braun dunkel		208 121 bordeaux		208 126 dunkelblau
	208 115 schwarz		208 128 grau meliert		208 127 grünoliv
	208 131 tobacco		208 134 natur meliert		208 130 sesam

02069-648 324 **Musterkarte** Wollfries  
21 Farben

1 Stück

Zur Konfektionierung von Wollfriesvorhängen:

112002-091127	<b>Gardinenband</b> <b>Musterkarte</b> Gardinenband	siehe Seite D 402 1 Stück
123101-091188	<b>Einfassband</b> zum Aufnähen <b>Musterkarte</b> Einfassband	siehe Seite B 15 (Katalog BP.12) 1 Stück
h75010x 02069-612280	<b>Kunstleder KAJA</b> <b>Farbmustersatz</b> KAJA	siehe Seite P 5 (Katalog BP.12) 1 Stück
h750 15x 02069-612 281	<b>Kunstleder URUGUAY</b> <b>Musterkarte</b> URUGUAY	siehe Seite P 6 (Katalog BP.12) 1 Stück

### Farbfilz

5 mm stark, ca. 90 cm breit, 100 % Polyester

1 m  
10 m  
20 m

#### Farben:

208100-		102 purpur		116 orange		137 dunkelgrau
		105 hellrosa		117 rostbraun		138 weiß
		106 graubeige		122 safrangelb		140 schwarz
		109 pastellblau		128 nussbraun		142 weinrot
		110 saphirblau		131 giftgrün		149 magenta
		112 hellblau		133 grün		151 feuerrot
		115 königsblau		134 dunkelgrün		

0206999-500 **Musterkarte** Farbfilz



## Gleiter für SM- und Aluschiene

ab Seite D 340



## Rollen für SM- und Aluschiene

Seite D 342



## Feststeller für SM- und Aluschiene

ab Seite D 344



## SB-Zubehör

ab Seite D 346

# Gleiter

Art.-Nr. Artikel-Bezeichnung VE

## **Clic-Gleiter** mit Faltenleghaken

An jeder Stelle einklickbar.



104018	HC 72, <i>langer Haken</i> ,	100 Stück
	für Aluschiene, Laufbreite 3,6 bis 4,0 mm	1.000 Stück
104047	HC 72, schwarz	100 Stück
104017	HC 92, <i>langer Haken</i> ,	100 Stück
	für Kunststoffschienen, Laufbreite 3,2 bis 4,6 mm	1.000 Stück
104019	HC 32, <i>langer Haken</i> ,	100 Stück
	für Aluschiene, Laufbreite 5,8 bis 6,2 mm	1.000 Stück
104030	HC 32, grau	100 Stück
104038	HC 32, schwarz	100 Stück

## **Clic-Gleiter** mit Faltenleghaken

An jeder Stelle einklickbar.



104021	HC 71, <i>kurzer Haken</i> ,	100 Stück
	für Aluschiene, Laufbreite 3,6 bis 4,0 mm	1.000 Stück
104048	HC 71, schwarz	100 Stück
104020	HC 91, <i>kurzer Haken</i> ,	100 Stück
	für Kunststoffschienen, Laufbreite 3,2 bis 4,6 mm	1.000 Stück
104022	HC 31, <i>kurzer Haken</i> ,	100 Stück
	für Aluschiene, Laufbreite 5,8 bis 6,2 mm	1.000 Stück
104031	HC 31, grau	100 Stück
104039	HC 31, schwarz	100 Stück
104023	HC 11, <i>kurzer Haken</i> ,	100 Stück
	für Aluschiene, Laufbreite 6,2 bis 6,6 mm	1.000 Stück

## **Klickgleiter** mit *drehbarem* Faltenleghaken

An jeder Stelle ein- und ausklickbar.



104033	Laufbreite 6 mm, weiß	100 Stück
--------	-----------------------	-----------

## **Drehgleiter** mit Faltenleghaken

An jeder Stelle ein- und ausdrehbar.



104805	Laufbreite 6 mm, weiß	100 Stück
--------	-----------------------	-----------

## **Drehgleiter** mit *drehbarem* Faltenleghaken

An jeder Stelle ein- und ausdrehbar.



104808	Laufbreite 6 mm, weiß	100 Stück
--------	-----------------------	-----------

## **Drehgleiter** mit Faltenleghaken

An jeder Stelle ein- und ausdrehbar.



104806	Laufbreite 4 mm, weiß	100 Stück
104807	Laufbreite 6 mm, weiß	100 Stück

## **Gleiter** mit Faltenleghaken

An jeder Stelle ein- und ausdrehbar.



104813	Laufbreite 6 mm, weiß	100 Stück
--------	-----------------------	-----------

## **Klickfix-Gleiter**

für gängige Schienen mit einer Laufbreite von 4 bis 6 mm und einer Kanalbreite von 10 mm und Kanalhöhe von 9 mm.

An jeder Stelle einklickbar.















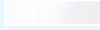



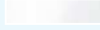









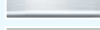

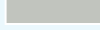













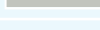



104810	weiß	100 Stück
--------	------	-----------

Art.-Nr.	Artikel-Bezeichnung	VE
107001	<b>Gleiter</b> mit Faltenleghaken runder Kopf 7 mm, für 4 mm Laufbreite	100 Stück
	<b>Gleiter</b> mit Faltenleghaken eckiger Kopf 11 x 9 mm	100 Stück 1.000 Stück 5.000 Stück
	<b>Kobra-Gleiter</b> Faltengleiter für Flachschiene runder Kopf 7 mm, für 4 mm Laufbreite	100 Stück
104904	<b>X-Gleiter</b> mit Faltenleghaken für Alu-Schiene Laufbreite 4 mm, weiß	100 Stück 1.000 Stück
	Laufbreite 6 mm, weiß	100 Stück 1.000 Stück
	Laufbreite 6 mm, schwarz	100 Stück 1.000 Stück
	<b>X-Gleiter Teflon</b> mit Faltenleghaken besonders gleitfähig durch PTFE-Beschichtung Laufbreite 6 mm, weiß	100 Stück 1.000 Stück
	Haken mit Drehgelenk, Laufbreite 6 mm, weiß	100 Stück 1.000 Stück
104051	<b>Schleuderwagen</b> mit Faltenleghaken Laufbreite 6 mm, mit X-Gleitern	100 Stück
107020	<b>Universal-Innenlaufgleiter</b> weiß	100 Stück
107042	<b>Ösengleiter</b> Laufbreite 4 mm, weiß	100 Stück
	Laufbreite 6 mm, weiß	100 Stück
	Laufbreite 6 mm, schwarz	100 Stück
112392	<b>Ösengleiter in Reihe</b> à 10 Stück Laufbreite 4 mm, weiß	500 Stück
	Laufbreite 6 mm, weiß	500 Stück
	Laufbreite 6 mm, schwarz	500 Stück
104036	<b>Clic-Gleiter</b> mit Öse, an jeder Stelle einklickbar HC 8, Laufbreite 4 mm	100 Stück
	HC 6, Laufbreite 5 mm	100 Stück
	HC 4, Laufbreite 6 mm	100 Stück
104034	<b>Klickgleiter</b> mit Öse, an jeder Stelle ein- und ausklickbar Laufbreite 6 mm, weiß	100 Stück
107045	<b>Faltenleghaken</b> für Ösengleiter doppelt weiß	100 Stück
	doppelt schwarz	100 Stück
	einfach weiß	100 Stück
112373	<b>LaOla Schlaufhaken</b> weiß	100 Stück
	silber	100 Stück
	schwarz	100 Stück

Art.-Nr.	Artikel-Bezeichnung	VE
	<b>Faltenlegrolle</b>	
104001	zylindrische Rolle, Rollen-Ø 9 mm, für SM-Schienen	100 Stück 1000 Stück 5000 Stück
	<b>Faltenlegrolle</b>	
104200	weiße, konische Rolle, Rollen-Ø 8 mm, für SM-Schienen	100 Stück 1000 Stück 5000 Stück
	<b>Faltenlegrollen</b>	
104002	konische Rolle, Rollen-Ø 8 mm, für SM-Schienen	100 Stück 1000 Stück 5000 Stück
	<b>Faltenlegrolle</b>	
104003	konische Rolle, Rollen-Ø 8 mm, langer Haken, Gesamthöhe 33 mm, für SM-Schienen	100 Stück 1000 Stück 5000 Stück
	<b>Faltenlegrolle</b>	
104046	konische Rolle, Rollen-Ø 8 mm, für SM- und Alu-Schienen mit Laubbreite 4 mm	100 Stück
	<b>Faltenlegrolle</b>	
104005	mit Kappe, Rollen-Ø 9 mm, für SM-Schienen	100 Stück 1000 Stück 5000 Stück
	<b>Stecklaufrolle</b>	
104004	konische Rolle, Rollen-Ø 8 mm, für SM-Schienen	100 Stück 1000 Stück 5000 Stück
	<b>Rollring mit Faltenleghaken</b> An jeder Stelle ein- und ausdrehbar.	
104049	Rollen-Ø 4,0 mm, weiß, für Alu-Schienen mit Laubbreite 6 mm, Gesamthöhe 32 mm <i>Variante als Gleiter: Art.-Nr. 104 813 – Seite D 340</i>	100 Stück
	<b>Gardinenhaken-Verlängerung</b>	
107048	weiß	100 Stück

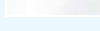
Art.-Nr.	Artikel-Bezeichnung	VE
<b>Innenlaufrolle</b>		
	<b>104009</b> konische Rolle, mit Kunststoffklammer, weiß, für SM-Schienen	 100 Stück 1000 Stück
<b>Schleuderwagen mit Faltenleghaken</b>		
	<b>104050</b> mit Kugelrollen 8 mm Ø, für SM-Schienen	 100 Stück
<b>Schlaufenrolle</b>		
	<b>104040</b> für Aluschiene mit 6 mm Laufbreite	 100 Stück
<b>Objektrolle</b>		
	<b>104045</b> für Aluschiene mit 6 mm Laufbreite, 1 kg Belastbarkeit pro Rolle	 100 Stück
<b>Objektrolle</b>		
 	extra flache Rolle: 4 mm Ø, mit PTFE-Beschichtung, für Aluschiene mit 6 mm Laufbreite, z.B. »Maxi« und »FLOW« <b>104809</b> mit Faltenleghaken <b>104815</b> mit Öse	 100 Stück 100 Stück
<b>Objektrolle</b>		
	<b>104041</b> für Aluschiene mit 8 mm Laufbreite	 100 Stück
<b>Objektgleiter</b>		
	<b>104814</b> X-Gleiter mit Faltenleghaken, für Aluschiene mit 8 mm Laufbreite	 100 Stück
	<b>T- und U-Laufrollen</b> auf den Seiten D 332 und D 333.	

# Feststeller

Art.-Nr.	Artikel-Bezeichnung	VE
<b>Zwischenfeststeller</b>		
106001	Universal 	100 Stück 
<b>Zwischenfeststeller</b>		
106002	mit Grobgewinde 	100 Stück 
<b>Zwischenfeststeller</b>		
104159	für T- und U-Schiene 	100 Stück 
<b>Zwischenfeststeller</b>		
106008	Universal 	100 Stück 
<b>Universalfeststeller</b>		
106023	für Laufbreite 3,8 bis 6,3 mm, weiß 	100 Stück 
<b>Zwischen- und Endfeststeller</b>		
106115	für Laufbreite 4 und 6 mm 	100 Stück 
<b>Zwischen- und Endfeststeller</b>		
106014	für Laufbreite 3,5 bis 4,0 mm, transp. 	100 Stück 
106025	für Laufbreite 5,2 bis 5,6 mm, transp. 	100 Stück 
106015	für Laufbreite 5,8 bis 6,2 mm, transp. 	100 Stück 
104032	für Laufbreite 5,8 bis 6,2 mm, grau 	100 Stück 
<b>Zwischenfeststeller</b>		
106012	für Laufbreite 4 mm, Kunststoff weiß 	100 Stück 
106011	für Laufbreite 6 mm, Kunststoff weiß 	100 Stück 
106024	für Laufbreite 6 mm, Kunststoff schwarz 	100 Stück 
<b>mit rutschhemmender Gummieinlage</b>		
106028	für Laufbreite 4 mm, Kunststoff weiß 	100 Stück 
106029	für Laufbreite 4 mm, Kunststoff schwarz 	100 Stück 
106019	für Laufbreite 6 mm, Kunststoff weiß 	100 Stück 
112366	für Laufbreite 6 mm, Kunststoff grau 	100 Stück 
<b>Metall + Kunststoff</b>		
106013	für Laufbreite 4 mm, Kunststoff transp. 	100 Stück 
106032	für Laufbreite 4 mm, Kunststoff schwarz 	100 Stück 
106018	für Laufbreite 6 mm, Kunststoff weiß 	100 Stück 
<b>Endfeststeller</b>		
106117	für Laufbreite 4 mm, weiß 	100 Stück 
106116	für Laufbreite 6 mm, weiß 	100 Stück 
<b>Endfeststeller</b>		
106009	für 4 mm Laufbreite, mit Klemme 	100 Stück 

Art.-Nr.	Artikel-Bezeichnung	VE	
	<b>Verschluss-Stopfen</b>		
	106020 Dekora, für Löcher 8 mm Ø	100 Stück	
	<b>Endfeststeller, rund</b>		
	106022 für Löcher 10,0 und 11,0 mm Ø	100 Stück	
	106004 für Löcher 12,5 und 14,5 mm Ø	100 Stück	
	<b>Endfeststeller, rund</b>		
106007 für Löcher 16 mm Ø	100 Stück		
	<b>Endfeststeller</b>		
	106005 für Vierkantloch	100 Stück	
	<b>Endfeststeller</b>		
	106006 für Rund- und Vierkantloch	100 Stück	
	<b>Endfeststeller</b>		
	106016 für Alu-Schienen	100 Stück	
	<b>Endfeststeller</b>		
	106017 für Vierkantloch, transparent	100 Stück	
	<b>Zugvorrichtungen</b>		
	126001 für Innenlaufschienen	10 Paar	
	<b>Gleitspray »Gleitfix«</b>		
	130001 Multispray	Sprühdose 400 ml	1 Dose
	130002 Silikon fettfrei	Sprühdose 400 ml	1 Dose 12 Dosen
	123121 PTFE Trockenschmiermittel	Sprühdose 400 ml	1 Dose
	<b>Schienenreiniger</b>		
	106026 für Laufbreite 4 mm (3,2 – 4,6 mm) HR 08		
	106027 für Laufbreite 6 mm (5,8 – 6,6 mm) HR 04	10 Stück 50 Stück 10 Stück 50 Stück	
	<b>Hand-Lochfräser, 12 mm Ø</b>		
	326536 für Lochbohrung in Kunststoffgardinenschienen	1 Stück	

**Ausklink-Zangen**  
für Kunststoff- und Alu-Schienen  
finden Sie auf Seite **D 328** –  
**Stufenbohrer** in unserem  
Werkzeugkatalog auf Seite **W 128**.







Art.-Nr. Artikel-Bezeichnung VE





**X-Gleiter**  
mit Faltenleghaken,  
für Alu-Schiene, Laufbreite 6 mm

604804 SB-verpackt à 20 Stück  20 Blister 



**Klick - Gleiter**  
An jeder Stelle einklickbar.

SB-verpackt à 20 Stück 

604018 für Alu-Vorhangschiene Laufbreite 3,6 – 4,0 mm 10 Blister 

604017 für Kunststoffschiene Laufbreite 3,2 – 4,6 mm 10 Blister

604019 für Alu-Vorhangschiene Laufbreite 5,8 – 6,2 mm 10 Blister



**Klick - Gleiter**, kurzer Haken

SB-verpackt à 20 Stück 



604021 für Alu-Vorhangschiene Laufbreite 3,6 – 4,0 mm 10 Blister 

604020 für Kunststoffschiene Laufbreite 3,2 – 4,6 mm 10 Blister

604022 für Alu-Vorhangschiene Laufbreite 5,8 – 6,2 mm 10 Blister





**Faltenlegrollen**  
konische Rolle, Rollen-Ø 8 mm,  
für SM-Schiene

604002 SB-verpackt à 20 Stück  20 Blister 





**Faltenlegrollen**  
mit Kappe, Rollen-Ø 9 mm,  
für SM-Schiene

604005 SB-verpackt à 20 Stück  20 Blister 



**Gleiter mit Faltenleghaken**  
runder Kopf 7 mm,  
für 4 mm Laufbreite















607001 SB-verpackt à 25 Stück  20 Blister 



**Schlaufengleiter**, für Innenlaufschiene  
SB-verpackt à 7 Stück 

615018 für 40 mm Schlaufen 20 Blister 

615038 für 50 mm Schlaufen 20 Blister

	Art.-Nr.	Artikel-Bezeichnung	VE
<b>Zwischenfeststeller</b>			
	606002	SB-verpackt à 4 Stück	 20 Blister 
<b>Zwischenfeststeller, Universal</b>			
	606008	SB-verpackt à 4 Stück	 20 Blister 
<b>Zwischen- und Endfeststeller für Laufbreite 4 und 6 mm</b>			
	606115	SB-verpackt à 4 Stück	 20 Blister 
<b>Endfeststeller für Vierkantloch</b>			
	606005	SB-verpackt à 6 Stück	 20 Blister 
<b>Endfeststeller für Rund- und Vierkantloch</b>			
	606006	SB-verpackt à 6 Stück	 20 Blister 

# SB-Zubehör für T-Schienen

<b>T-Rollen</b> Kunststoff mit Faltenleghaken			
	604028	SB-verpackt à 20 Stück	 20 Blister 
<b>T-Gleiter</b> Kunststoff			
	607030	SB-verpackt à 20 Stück	 20 Blister 
<b>T-Feststeller</b> Kunststoff			
	606030	SB-verpackt à 6 Stück	 20 Blister 

Art.-Nr. Artikel-Bezeichnung VE

**Stahlstecknadeln**  
fein und rostfrei



615005 SB-Dose à 100 Stück



25 Dosen

**Messingstecknadeln**  
105 /30 mm  
silberfarbig



615002 AV SB-Dose à 50 g



1 Dose  
20 Dosen

**Kunststoff-Stecknadeln**  
ohne Widerhaken



615 030 SB-Dose à 150 Stück



50 Dosen

**Kunststoff-Stecknadeln**  
mit Widerhaken



615035 SB-Dose à 100 Stück



50 Dosen

**Faltenstecker**, für Feinstores  
glasklar



615050 SB-verpackt à 50 Paar



20 Blister

**Ringe** mit Faltenleghaken,  
Kunststoff, 32/20 mm,  
weiß



503080 SB-verpackt à 8 Stück



1 Blister

**Faltenleghaken**  
glasklar

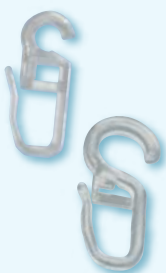

SB-verpackt à 12 Stück

604006 Öse 6 mm Ø

604007 Öse 10 mm Ø



20 Blister

20 Blister

Art.-Nr. Artikel-Bezeichnung VE

### Kunststoff-Raffhaken, selbstklebend

SB-verpackt à 2 Stück



680387

weiß



20 Blister



### Winkelklebehaken, verstellbar zum Nachspannen und Korrigieren von Spanngardinen

SB-verpackt à 4 Stück



610047

weiß



20 Blister



### Klebehaken, mit Metallstift

SB-verpackt à 4 Stück



610053

weiß

610054

braun



25 Blister

25 Blister



### Tischtuchklammern

Metall

SB-Karte à 4 Stück



129 682

129682

mit Blattfeder, Edelstahl

Plattenstärke bis 30 mm



10 Karten

129678

mit Feder, vernickelt

bis 45 mm

10 Karten



129 678

### Tischtuchklammern

Kunststoff

SB-Karte à 4 Stück



129679

verstellbar, glasklar

Plattenstärke bis 40 mm



10 Karten





## ED Raffvorhangsystem 2.1

ab Seite D 352



## ED Raffvorhangsystem 2.3

ab Seite D 354

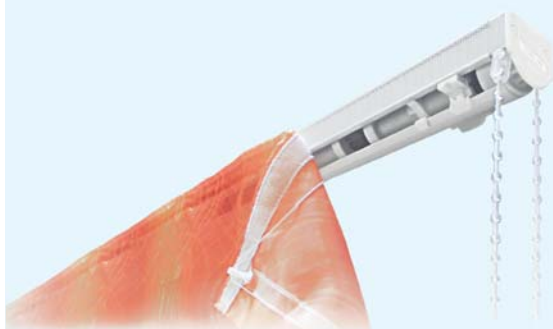

## ED Raffvorhangsystem ELEGANT

ab Seite D 356



## Kordeln, Raffrollobänder, Zubehör

ab Seite D 358



## Beschwerungssysteme für Raff- und Flächenvorhänge

ab Seite D 363

- Behang ohne Entfernen der Aufzugschnüre abnehmbar
- leichte Handhabung
- kompakte Antriebstechnik mit 3:1 Untersetzung
- Raffvorhang mit Kettenzug, in jeder Höhe arretierbar
- Vorhang wird mit einer nicht sichtbaren Clip-Technik befestigt
- Bedienung mit Kugelskette, Bedienhöhe: 125 cm
- Schnurclip ist frei verschiebbar und positioniert sich automatisch zu einer korrekten Schnurführung

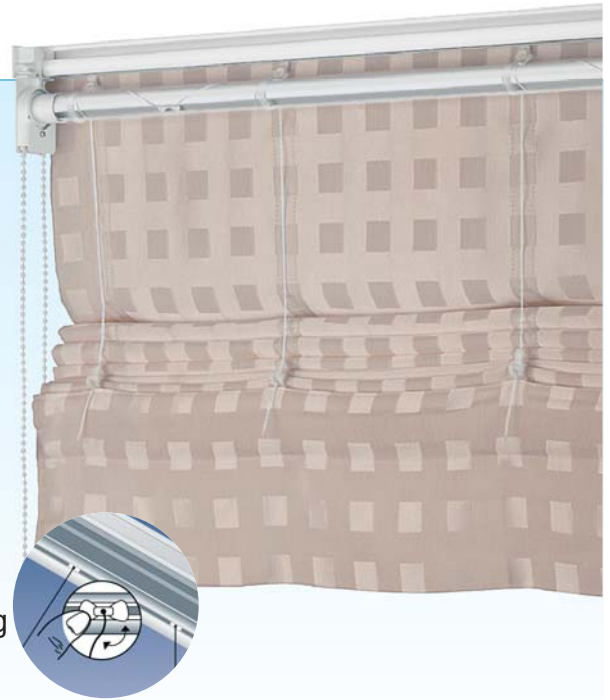

## Garnituren

Weiß, inklusive folgender Komponenten: Oberschiene inkl. Haftband, Antrieb, Abschlusskappen und Drehwelle, sowie:



siehe Tabelle



siehe Tabelle



siehe Tabelle



siehe Tabelle



Kette





Beschwerung

	Art.-Nr.	Breite	Schnurclip + Schnurregler	Träger	Wellenstütze
<b>011500</b>	-080	80 cm	4 Stück	2 Stück	
	-090	90 cm	4 Stück	2 Stück	
	-100	100 cm	4 Stück	2 Stück	
	-110	110 cm	4 Stück	2 Stück	
	-120	120 cm	4 Stück	3 Stück	
	-130	130 cm	6 Stück	3 Stück	
	-140	140 cm	6 Stück	3 Stück	
	-150	150 cm	6 Stück	3 Stück	1 Stück
	-160	160 cm	6 Stück	3 Stück	1 Stück
	-170	170 cm	6 Stück	3 Stück	1 Stück
	-180	180 cm	6 Stück	3 Stück	1 Stück
	-190	190 cm	8 Stück	3 Stück	1 Stück
	-200	200 cm	8 Stück	3 Stück	1 Stück
	-210	210 cm	8 Stück	4 Stück	1 Stück
	-220	220 cm	8 Stück	4 Stück	1 Stück
	-230	230 cm	10 Stück	4 Stück	2 Stück
	-240	240 cm	10 Stück	4 Stück	2 Stück
	-250	250 cm	10 Stück	5 Stück	2 Stück

Jedes Zwischenmaß ist möglich und wird zum nächsthöheren Preis berechnet!  
Bitte bei der Bestellung die Bedienungsseite der Kette angeben!

Das Raffrolloband ED 112 026 oder ED 112 027 (transparent) und die dünne Raffrollo-Kordel ED 126 005 bitte extra bestellen!

Art.-Nr.	Artikel-Bezeichnung	VE
	<b>Alu-Schiene mit Klett-Haftband</b> 1 Länge à 6 m weiß	
	<b>Alu-Drehwelle</b> 1 Länge à 6 m weiß  * Verschnitt ist selbst einzukalkulieren.	
	<b>Antrieb</b> komplett mit Abschlusskappen und Kettenzug	1 Paar 5 Paar 20 Paar
	126098 Bedienhöhe 125 cm, Standard 126098-1 Bedienhöhe 90 cm 126098-2 Bedienhöhe 170 cm	
	<b>Wellenstütze</b>	1 Stück 10 Stück
	<b>Schnurclip</b>	100 Stück 
	<b>Mitnehmer</b> , Alternative zum Schnurclip	20 Stück
	<b>Raffkordelklemme / Schnurregler</b> zum Festklemmen der Raffkordel	1 Stück 100 Stück
	<b>Führungsring</b> glasklar, 8 / 13 mm	100 Stück 
	<b>Raffrollo-Kordel</b> , Polyester, weiß 0,8 mm Ø	700 m 
	<b>Wand- und Deckenträger mit Knebel</b>	1 Stück 20 Stück
	<b>Klemmträger für Fensterflügel</b>	1 Stück 20 Stück
	<b>Klemmträger für Innenlaufschiene</b>	1 Stück 20 Stück
	<b>Stahlrohr</b> , kunststoffummantelt weiß, 12 mm Ø, 1 Länge à 5 m * Verschnitt ist selbst einzukalkulieren.	5 m 25 m 50 m
	<b>Endstopfen</b> , Kunststoff weiß, für 12 mm Ø Rohre	100 Stück 



- Raffvorhang-Technik mit einer Zugschnur
- Antrieb mit Zugkraftregulierung
- komplett abnehmbarer Vorhang
- Näh- und Montageanleitung
- 20 mm Alu-Welle mit Spulen-Mitnehmer und Kordel-Führungsösen
- Bedienung mit Kugelschnur, Standardlänge: 150 cm
- automatische Tarierung



## Garnituren

Weiß, inklusive folgender Komponenten: Oberschiene Aluminium mit Haftband, Antrieb und Drehwelle, sowie:



Art.-Nr.	Breite	Spulen-Mitnehmer + Führungsöse	Träger	Wellenstütze
011501 -040	40 cm	2 Stück	2 Stück	
-050	50 cm	2 Stück	2 Stück	
-060	60 cm	4 Stück	2 Stück	
-070	70 cm	4 Stück	2 Stück	
-080	80 cm	4 Stück	2 Stück	1 Stück
-090	90 cm	4 Stück	2 Stück	1 Stück
-100	100 cm	4 Stück	2 Stück	1 Stück
-110	110 cm	4 Stück	2 Stück	1 Stück
-120	120 cm	4 Stück	3 Stück	1 Stück
-130	130 cm	6 Stück	3 Stück	2 Stück
-140	140 cm	6 Stück	3 Stück	2 Stück
-150	150 cm	6 Stück	3 Stück	2 Stück
-160	160 cm	6 Stück	3 Stück	2 Stück
-170	170 cm	6 Stück	3 Stück	2 Stück
-180	180 cm	6 Stück	3 Stück	2 Stück
-190	190 cm	8 Stück	3 Stück	3 Stück
-200	200 cm	8 Stück	3 Stück	3 Stück
-210	210 cm	8 Stück	4 Stück	3 Stück
-220	220 cm	8 Stück	4 Stück	3 Stück
-230	230 cm	10 Stück	4 Stück	4 Stück
-240	240 cm	10 Stück	4 Stück	4 Stück
-250	250 cm	10 Stück	5 Stück	4 Stück

Jedes Zwischenmaß ist möglich und wird zum nächsthöheren Preis berechnet!  
Bitte bei der Bestellung die Bedienungsseite der Kette angeben!

Das Raffrolloband ED 112 026 oder ED 112 027 (transparent) und die dünne Raffrollo-Kordel ED 126 005 bitte extra bestellen!

Art.-Nr.	Artikel-Bezeichnung	VE
126071-1	<b>Alu-Schiene mit Klett-Haftband</b> 1 Länge à 6 m weiß	6 m 3.007700
		30 m
126070-1	<b>Alu-Drehwelle</b> 1 Länge à 6 m weiß	6 m 3.007000
		30 m 2.006300
* Verschnitt ist selbst einzukalkulieren.		
126096	<b>Antrieb</b> mit Zugkraftregulierung	1 Paar 5 Paar 20 Paar
126081	<b>Wellenstütze</b>	1 Stück 10 Stück
126088	<b>Zugschnur-Spalsegment</b>	1 Stück 20 Stück 100 Stück
126089	<b>Zugschnur-Führungsöse</b> mit Klebepad	1 Stück 20 Stück 100 Stück
129649	<b>Führungsring</b> glasklar	100 Stück
126005	<b>Raffrollo-Kordel</b> , Polyester, weiß 0,8 mm Ø	700 m
126097	<b>Kugelschnur</b> Kugelabstand 6,5 mm	250 m
126341	<b>Kettenschloss / Stopper</b> transparent Kann mit oder ohne Kindersicherung montiert werden, das zusätzliche Gehäuse verriegelt dauerhaft.	1 Stück
126074	<b>Träger mit C-Öse</b> Innen-Ø 10 mm	20 Stück
126078	<b>Wand- und Deckenträger mit Knebel</b>	1 Stück 20 Stück
126079	<b>Klemmträger für Fensterflügel</b>	1 Stück 20 Stück
126080	<b>Klemmträger für Innenlaufschiene</b>	1 Stück 20 Stück
503180	<b>Stahlrohr</b> , kunststoffummantelt weiß, 12 mm Ø, 1 Länge à 5 m * Verschnitt ist selbst einzukalkulieren.	5 m 25 m 50 m
126020	<b>Endstopfen</b> , Kunststoff weiß, für 12 mm Ø Rohre	100 Stück

- Innovatives System mit kompakter Antriebseinheit
- Raffvorhangtechnik in weiß oder silber
- dezente, unauffällige Technik
- geringer Platzbedarf (Maße inklusive Träger) – Breite nur 45mm – Höhe nur 40mm
- Behang ohne Entfernen der Kordelschnüre abnehmbar
- Raffvorhang mit Kettenzug, in jeder Höhe arretierbar
- Bedienung mit Kugelschleife, Standardlänge: 125cm
- leichte Handhabung
- Näh- und Montageanleitung

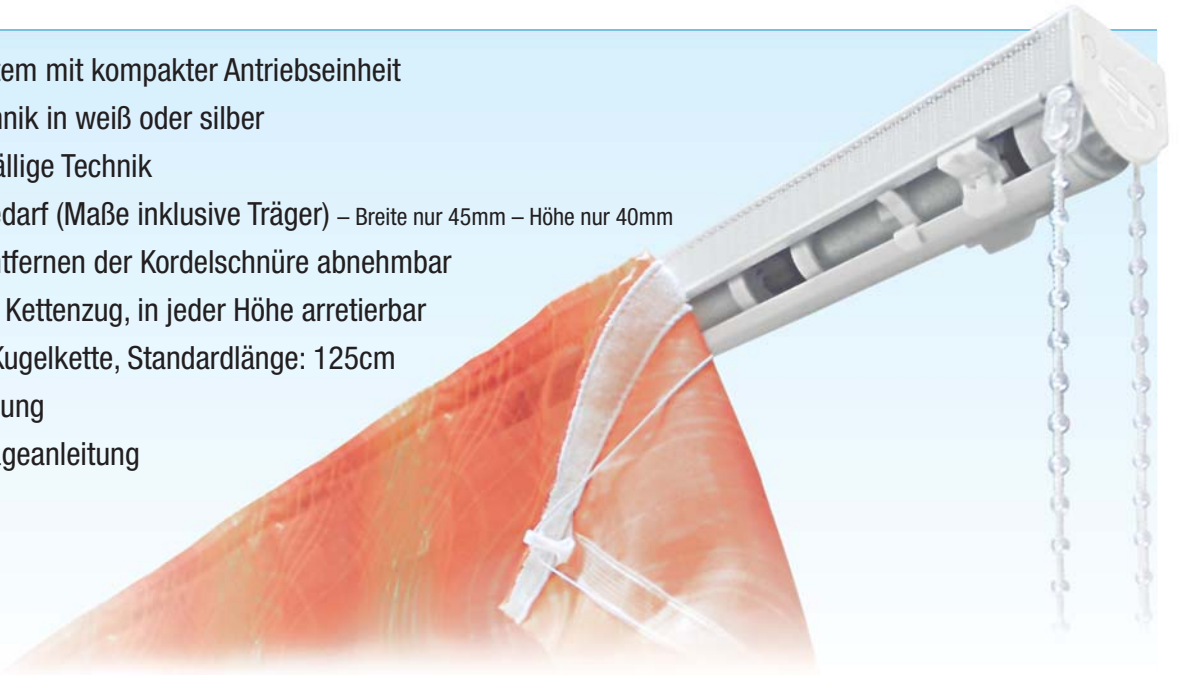

## Garnituren

Weiß oder silber, inklusive folgender Komponenten: Aluminiumprofil mit Standardgetriebe, Endkappen, Klettleiste, Drehwelle, sowie:



siehe Tabelle



siehe Tabelle



siehe Tabelle





siehe Tabelle



Kette mit Schloss



Beschwerung

Farbe	Art.-Nr.	bis Breite	Spultechniken je rechts + links	Führungöse + Kordelklemme	Wand- und Deckenträger
weiß 	<b>011502</b> -080	80 cm	2 Stück	4 Stück	2 Stück
silber 	<b>011503</b> -090	90 cm	2 Stück	4 Stück	2 Stück
	-100	100 cm	2 Stück	4 Stück	2 Stück
	-110	110 cm	3 Stück	6 Stück	2 Stück
	-120	120 cm	3 Stück	6 Stück	2 Stück
	-130	130 cm	3 Stück	6 Stück	3 Stück
	-140	140 cm	3 Stück	6 Stück	3 Stück
	-150	150 cm	3 Stück	6 Stück	3 Stück
	-160	160 cm	4 Stück	8 Stück	3 Stück
	-170	170 cm	4 Stück	8 Stück	3 Stück
	-180	180 cm	4 Stück	8 Stück	4 Stück
	-190	190 cm	4 Stück	8 Stück	4 Stück
	-200	200 cm	4 Stück	8 Stück	4 Stück
	-210	210 cm	4 Stück	8 Stück	4 Stück
	-220	220 cm	5 Stück	10 Stück	4 Stück
	-230	230 cm	5 Stück	10 Stück	5 Stück
-240	240 cm	5 Stück	10 Stück	5 Stück	
-250	250 cm	5 Stück	10 Stück	5 Stück	

Weitere Größen bis 300 cm auf Anfrage –  
jedes Zwischenmaß ist möglich und wird zum nächsthöheren Preis berechnet!  
Bitte bei der Bestellung die Bedienungsseite der Kette angeben (links oder rechts)!







Das Raffrollband ED 112 026 oder ED 112 027 (transparent) und die dünne Raffrollo-Kordel ED 126 005 bitte extra bestellen!

Art.-Nr.	Artikel-Bezeichnung	VE
<b>Getriebe</b>		
126334	Standard, Übersetzung 1:1	1 Stück
126342	für schwere Vorhänge, Übersetzung 3:1	1 Stück
<b>Führungsöse</b>		
126339	zum Einnähen	1 Stück
<b>Kordelklemme / Schnurregler</b>		
126090	zum Festklemmen der Raffkordel	1 Stück 100 Stück
<b>Führungsring</b>		
129649	glasklar	100 Stück 
<b>Raffrollo-Kordel</b> , Polyester, weiß		
126005	0,8 mm Ø	700 m 
126340	<b>Kugelschleife</b> Kugelabstand 12 mm	250 m
126341	<b>Kettenschloss / Stopper</b> transparent Kann mit oder ohne Kindersicherung montiert werden, das zusätzliche Gehäuse verriegelt dauerhaft.	1 Stück
<b>Wand- und Deckenträger</b>		
126346	weiß	1 Stück
126347	silber	1 Stück
126323	<b>Klemmträger</b> für Fensterflügel weiß, ohne Wand- und Deckenträger	1 Stück
<b>Stahlrohr</b> , kunststoffummantelt		
503185	10 mm Ø, weiß	1 Länge à 5,00 m 5 m 25 m 50 m
503180	12 mm Ø, weiß	1 Länge à 5,00 m 5 m 25 m 50 m
* Verschnitt ist selbst einzukalkulieren.		
<b>Endstopfen</b> , Kunststoff 		
126039	weiß, für 10 mm Ø Rohre	100 Stück
126020	weiß, für 12 mm Ø Rohre	100 Stück

# Kordeln

Art.-Nr. Artikel-Bezeichnung VE



<b>Raffrollo-Kordel</b> , Polyester					
126005	0,8 mm Ø, weiß				700 m
126005-	0,8 mm Ø, farbig				700 m
4000	schwarz		1222	beige	
412	hellgrau		1224	mittelbraun	
1002	dunkelbraun				
Weitere Farben auf Anfrage!					



<b>Rollokordel</b> , Polyester, weiß					
126007	1 mm Ø				100 m







<b>Rollo-Schlauchkordel</b> , weiß					
126004	1 mm Ø	Rolle à 500 m			1 Rolle



<b>Flechtschlauch-Faden</b> , weiß					
214007	1,2 mm Ø	Rolle à 500 m			1 Rolle



<b>Jalousie-Kordel</b> extra fest, fein					
126008	1,5 mm Ø, weiß				100 m
126009	1,5 mm Ø, schwarz				100 m
126048	2,5 mm Ø, weiß				500 m
126049	3,0 mm Ø, weiß				500 m

<b>Jalousie-Schlauchkordel</b>					
126047	2,0 mm Ø, weiß	Rolle à 300 m			1 Rolle



<b>Perlonkordel</b> , Polyamid					
126021	1 mm Ø, weiß				250 m
126022	2 mm Ø, weiß				250 m
126023	3 mm Ø, weiß				250 m
126023-1	3 mm Ø, schwarz				250 m
126024	4 mm Ø, weiß				100 m
126024-1	4 mm Ø, schwarz				100 m
126035	5 mm Ø, weiß				100 m
126036	6 mm Ø, weiß				100 m

<b>Deko-Nylonschnur</b> , transparent					
130103	0,3 mm Ø	Rolle à 100 m			1 Rolle
130105	0,5 mm Ø	Rolle à 100 m			1 Rolle

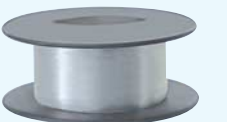





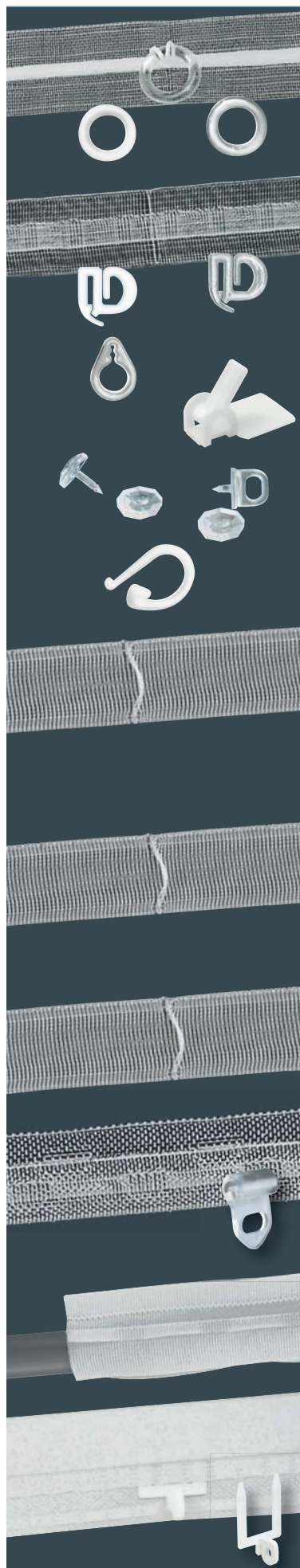





<b>Nylonseil</b> , transparent					
130110-1	2 mm Ø	Rolle à 100 m			1 Rolle 10 Rollen

# Raffrollobänder



Art.-Nr.	Artikel-Bezeichnung	VE
112005	<b>Wolkenstoresband</b> (Faltrolloband), mit Ringen, Polyester transparent, 24 mm breit, Ringabstand 15,5 cm	50 m
129648	<b>Ringe</b> für Wolkenstoresband und Raffstores, 8/13 mm weiß	100 St.
129649	glasklar	100 St.
112020	<b>Creativband</b> für S-Haken, Ringabstand variabel, Tasche an Tasche transparent, 15 mm breit, zum Aufnähen	200 m
112022	<b>S-Haken</b> weiß	100 St.
112025	klar	100 St.
112023	<b>Schnur-Endring</b> für Creativband, glasklar	100 St.
126090	<b>Schnur-Regler</b> / Kordelklemme	1 Stück 100 Stück
115050	<b>Faltenstecker</b> glasklar	1.000 St.
126026	glasklar, mit Schnurführungsring	100 St.
115052	<b>Faltenhalter</b> wasserklar	100 St.
115055	weiß	100 St.
112026	<b>Faltrolloband</b> , mit Schlaufen, Polyester, transparent, <b>aufnähar</b> 17,5 mm breit Schlaufenabstand 15 cm	200 m
112027	Schlaufenabstand 5 cm	200 m
112042	17,5 mm breit, mit <b>aufstehenden Schlaufen</b> für schnellen Kordeldurchzug Schlaufenabstand 15 cm	200 m
112043	Schlaufenabstand 5 cm	200 m
	<b>Raffrollofix-Band</b> , mit Schlaufen, transparent, <b>fixierbar mit Dampf</b> , zum Nachnähen 17,0 mm breit	
112046	Schlaufenabstand 15 cm	100 m
112047	Schlaufenabstand 5 cm	100 m
112044	17,5 mm breit, mit <b>aufstehenden Schlaufen</b> für schnellen Kordeldurchzug Schlaufenabstand 15 cm	150 m
112045	Schlaufenabstand 5 cm	150 m
112048	<b>Raffrollo-Band</b> , mit Schlaufen, transparent, <b>selbstklebend</b> , zum Nachnähen 17,5 mm breit	
	Schlaufenabstand 5 cm	
	<b>Durchschubband</b> , Polyester, transparent, für Beschwerungsprofile	
112052	17 mm breit	100 m
112053	26 mm breit	100 m
115034	<b>Faltenclip</b> transparent	100 St.
112040	<b>Stangendurchschubband</b> , Polyester, für Faltrillos für 10 mm Ø zum Aufnähen	100 m
112057	<b>Rollo-Taschen-Band</b> für die Schnurzugführung bei Raffrollos, zum Aufbügeln. Beim Waschen verbleiben Zugschnüre und Ösen im Rollo. weiß, 37 mm breit	25 m
112058	weiß, 55 mm breit	25 m
112060	<b>Zugschnur-Öse</b> weiß, für Rollo-Taschen-Band 37 mm	50 St.
112061	weiß, für Rollo-Taschen-Band 55 mm	50 St.



Art.-Nr.	Artikel-Bezeichnung	VE
<b>Ringschrauben, offen</b> glanzverzinkt, Öffnung 3,5 mm		
 130080	Größe: 6 x 16 mm	 100 Stück 1000 Stück
<b>Ringschrauben, geschlossen</b> glanzverzinkt		
 130090	Ösen-Ø 6 mm – Stiftlänge 16 mm	 100 Stück 1000 Stück
130060 130070	Ösen-Ø 10 mm – Stiftlänge 20 mm Ösen-Ø 10 mm – Stiftlänge 30 mm	100 Stück 100 Stück
<b>Schnurführer</b>		
 126002	mit Porzellaneinlage, Ösen-Ø 9 mm – Stiftlänge 25 mm	100 Stück
<b>Schnurspanner</b> mit Feder Stahlrohr mit Metall-Rolle		
 126055	Metall, weiß, Länge 88 mm – ausziehbar bis 128 mm	10 Stück
<b>Schnurwickler</b> doppelt, 75 mm lang, Messing massiv		
 126013	vernickelt	25 Stück
 126113	weiß beschichtet	25 Stück
 126050	messing glanz	25 Stück
<b>Rollokordelklemme / Schnurklemme</b>		
 126311	transparent	50 Stück
<b>Zugschnur-Führungsöse / Schnurumlenker</b>		
 126312	transparent	50 Stück
<b>Schnurwickler, Haspel</b> mit Schraube und Dübel, 17 x 34 mm		
 126060	Kunststoff, weiß	 10 Stück

	Art.-Nr.	Artikel-Bezeichnung	VE
	126028	<b>Schnurklemme</b> mit Schraube	
		Kunststoff, weiß	100 Stück 500 Stück
	126029	<b>Schnurwickler</b> mit Halteplatte Selbstklebend, für Fensterrahmen	
		Kunststoff, weiß	25 Stück 50 Stück
	126170	<b>Schnurwickler</b> mit Halteplatte Selbstklebend, für Fensterrahmen Zum Aufwickeln einer Jalousie-Schnur.	
		Kunststoff, weiß	10 Stück
	126173	<b>Schnurwickler</b> Klemmhalter mit Klebefläche Zum Aufwickeln einer Jalousie-Schnur, kann links und rechts am Fensterflügel montiert werden.	
		Metall und Kunststoff, weiß	10 Stück
	112127	<b>Schnur-Aufwickler</b> für Gardinen- und Faltenbänder sowie Zugschnüre, Kunststoff	
		weiß	10 Stück  100 Stück
	112128	klein, weiß	500 Stück 
	126054	<b>Umlenkrolle</b> Zum Fixieren an Fensterrahmen und Wänden, für Zugschnüre und Kugelketten ohne Kettenschloss.	
		Kunststoff, weiß	100 Stück
	126174	<b>Kettenhalter</b> Klemmhalter mit Klebefläche, fixiert die Kette am Fensterrahmen. Für alle Ketten geeignet, auch mit Kettenverbinder, kann links oder rechts am Fensterflügel montiert werden.	
		Metall und Kunststoff, weiß	10 Stück



# Kordelgewichte

Art.-Nr.	Artikel-Bezeichnung	VE
	<b>Schnurbeschwerer</b> mit Rolle	
126040	Kunststoff, weiß, ca. 140 g	1 Stück
	<b>Quaste</b>	
126019	Kunststoff, weiß	100 Stück
	<b>GLOCKE</b> Schnurverbinder und Endquaste	
126027	Kunststoff, weiß	20 Stück 100 Stück
	<b>DREIECK</b> Quaste für Raffvorhänge	
126500	Kunststoff, edelstahl	10 Stück
	<b>Schraubkugel</b> Ø 14 mm Metall, Schnurdurchführung 4,0 mm	
126042	silber	100 Stück
	<b>Kordel-Gewicht</b> Ø 35 mm Messing massiv, ca. 45 g	
126225	messing-matt	25 Stück
	<b>ZYLINDER</b> Aluminium, für Schnurzüge	
	8,5 cm hoch      2,8 cm Ø      140 g	
11688-08	alu matt	1 Stück
11688-22	chrom glanz	1 Stück
11688-48	weiß matt	1 Stück
11688-29	nickel matt	1 Stück
11688-157	schwarz matt	1 Stück
	<b>ZYLINDER MIT GUMMIRING</b> Aluminium, für Schnurzüge	
	8,5 cm hoch      2,8 cm Ø      150 g	
11689-08	alu matt	1 Stück
11689-22	chrom glanz	1 Stück
11689-48	weiß matt	1 Stück
11689-29	nickel matt	1 Stück
11689-157	schwarz matt	1 Stück
	<b>Kordel-Halter</b> mit Schrauben	
126017	Kunststoff, weiß	100 Stück

Art.-Nr.	Artikel-Bezeichnung	VE
		
<b>Kunststoff-Beschwerungs-Profil</b>		
12 x 5 mm, mit Verbindungsstück		
112019	weiß	1 Länge à 2,50 m 125 m 250 m
		
<b>Kunststoff-Beschwerungs-Profil</b>		
12 x 5 mm, mit weißem Verbindungsstück		
112014	transparent	1 Länge à 2,50 m 125 m 250 m
		
<b>Kunststoff-Beschwerungsstab, rund</b>		
100104-2	4 mm Ø, transparent	1 Länge à 2,00 m 50 Stück
		
100105	10 mm Ø, transparent	1 Länge à 1,43 m 10 Stück 50 Stück
100105-1	10 mm Ø, transparent	1 Länge à 6,00 m 10 Stück
		
<b>Plexiglas-Flachstab</b>		
100106	15 x 3 mm, glasklar	1 Länge à 1,50 m 10 Stück 20 Stück
100106-1	15 x 3 mm, glasklar	1 Länge à 2,45 m 10 Stück 20 Stück
		
126065	25 x 3 mm, glasklar	1 Länge à 1,50 m 10 Stück 20 Stück
126065-1	25 x 3 mm, glasklar	1 Länge à 2,45 m 10 Stück 20 Stück
		
<b>Endkappen</b>		
126320	glasklar, für Flachstab 25 x 3 mm	100 Stück
		
<b>Verbinder</b>		
126321	glasklar, für Flachstab 25 x 3 mm	50 Stück

Art.-Nr. Artikel-Bezeichnung VE

## Stahlrohr Kunststoffummantelt



503185 10 mm Ø, weiß 1 Länge à 5,00 m 5 m  
25 m  
50 m



503180 12 mm Ø, weiß 1 Länge à 5,00 m 5 m  
25 m  
50 m

\* Verschnitt ist selbst einzukalkulieren.

## Endstopfen Kunststoff



126039 weiß, für 10 mm Ø Rohre 100 Stück

126020 weiß, für 12 mm Ø Rohre 100 Stück

## Verbinder Kunststoff



503181 weiß, für 10 und 12 mm Ø Rohre 10 Stück  
100 Stück

## Aluminium-Beschwerungsstab 25 x 3 mm



100102 weiß 1 Länge à 2,65 m 2,65 m  
100102-1 weiß 1 Länge à 6,00 m 6,00 m



100103 alu matt 1 Länge à 2,65 m 2,65 m  
100103-1 alu matt 1 Länge à 6,00 m 6,00 m

\* Verschnitt ist selbst einzukalkulieren.



Beschwerungssysteme für Raff- und Flächenvorhänge

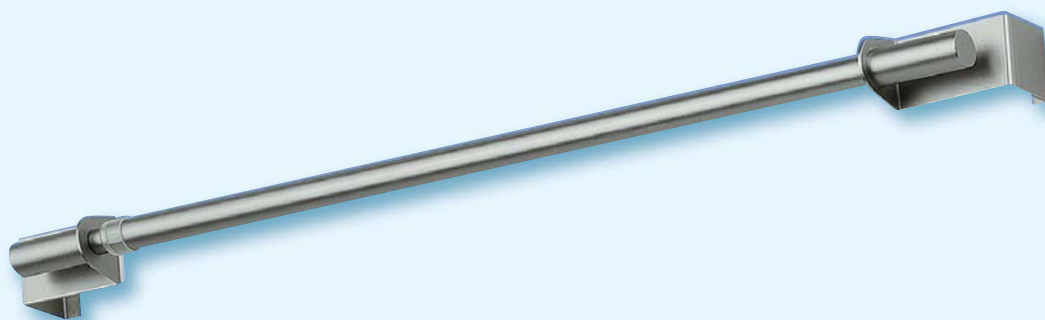

## Vitragestangen

ab Seite D 366



## Befestigungen | Klemmträger

ab Seite D 374



## Gardinenringe | Haken | Donauklammern

ab Seite D 378

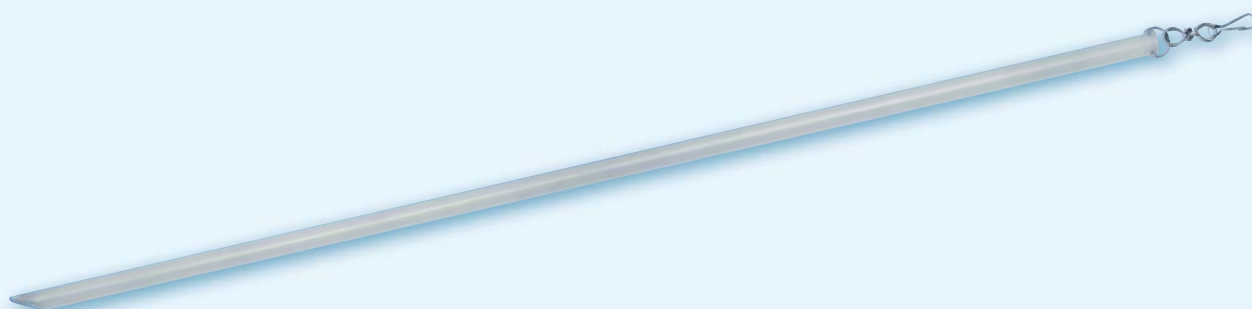

## Schleuderstäbe | Schleuderquasten

ab Seite D 380



Art.-Nr. Artikel-Bezeichnung VE

**SpannFix Vitragenstange**  
mit SpannSystem für Rahmen bis max. 17 mm  
Edelstahl 9 mm Ø  
SB-verpackt à 1 Stück im Polybeutel

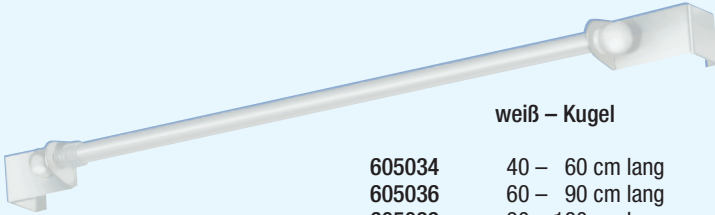

**weiß – Kugel**

605034	40 – 60 cm lang	5 Stück
605036	60 – 90 cm lang	5 Stück
605039	90 – 130 cm lang	5 Stück
605040	120 – 160 cm lang	5 Stück



**nickel – Kugel**

605010	40 – 60 cm lang	5 Stück
605011	60 – 90 cm lang	5 Stück
605012	90 – 130 cm lang	5 Stück
605013	120 – 160 cm lang	5 Stück

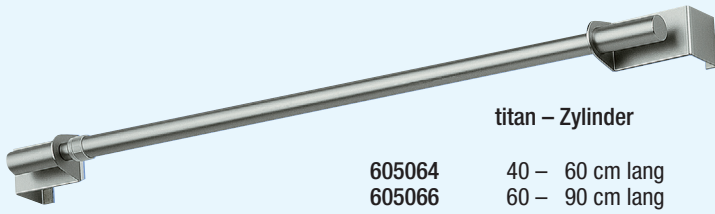

**titan – Zylinder**

605064	40 – 60 cm lang	5 Stück
605066	60 – 90 cm lang	5 Stück
605069	90 – 130 cm lang	5 Stück
605070	120 – 160 cm lang	5 Stück

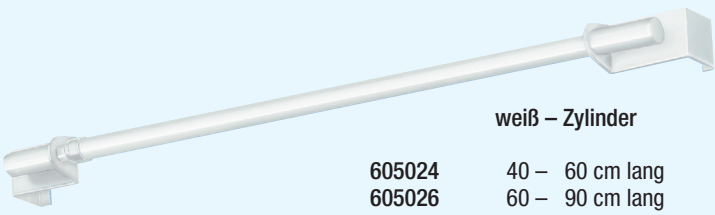

**weiß – Zylinder**

605024	40 – 60 cm lang	5 Stück
605026	60 – 90 cm lang	5 Stück
605029	90 – 130 cm lang	5 Stück
605033	120 – 160 cm lang	5 Stück



**schwarz – Zylinder**  
Mit schlanken Fensterhalterungen

605060	40 – 60 cm lang	5 Stück
605061	60 – 90 cm lang	5 Stück
605062	90 – 130 cm lang	5 Stück
605063	120 – 160 cm lang	5 Stück

Art.-Nr. Artikel-Bezeichnung VE



**Träger für Alu-Fenster**  
bis max. 7 mm Rahmenstärke

605050	weiß		5 Paar
605051	alu matt		5 Paar

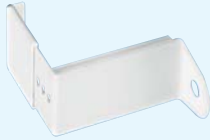

**Träger für Thermo-Fenster**  
einstellbar für 20 bis 28 mm Rahmenstärke

605052	weiß		5 Paar
605053	titan		5 Paar
605055	messing-matt		5 Paar
605057	chrom		5 Paar



**SpannFix Raffrollosystem**  
Ergänzungs-Set

605043	29 – 49 cm lang		weiß	1 Stück 5 Stück
605045	49 – 79 cm lang		weiß	1 Stück 5 Stück
605047	79 – 119 cm lang		weiß	1 Stück 5 Stück

Inkl. Schnurschloss, Profil mit Klettband (kürzbar), Umlenker, Schnurklemmen, Kordelgriff, Plexi-Abschluss-Profil mit Endkappen und Verbinder, Adapter (55mm) für Kunststoff-Fenster.

SpannFix-Stange, Rollobänder und Zugkordel bitte gesondert bestellen.



**Faltrolloband**, aufnähar  
17,5 mm breit, transparent,  
mit aufstehenden Schlaufen für schnellen Kordeldurchzug

112042	Schlaufenabstand 15 cm		200 m
112043	Schlaufenabstand 5 cm		200 m



**Raffrollofix-Band**, fixierbar mit Dampf, zum Nachnähen  
17,5 mm breit, transparent,  
mit aufstehenden Schlaufen für schnellen Kordeldurchzug

112044	Schlaufenabstand 15 cm		150 m
112045	Schlaufenabstand 5 cm		150 m



**Schnurschloss**

126310	weiß		10 Stück
--------	------	--	----------

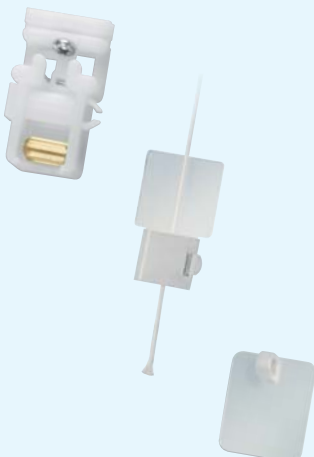

**Rollokordelklemme / Schnurklemme**

126311	transparent		50 Stück
--------	-------------	--	----------

**Zugschnur-Führungsöse / Schnurumlenker**

126312	transparent		50 Stück
--------	-------------	--	----------

# Klemmstange DYNAMIC

Art.-Nr. Artikel-Bezeichnung

VE

## Klemmstange DYNAMIC

Geeignet für alle Fenster.  
Stangen-Ø: 7 / 9 mm

lose verpackt



Einfache Montage, ohne bohren oder kleben



	<b>weiß</b>	
610499	25 – 40 cm lang	20 Stück
610500	40 – 60 cm lang	20 Stück
610501	60 – 90 cm lang	20 Stück
610502	80 – 120 cm lang	20 Stück

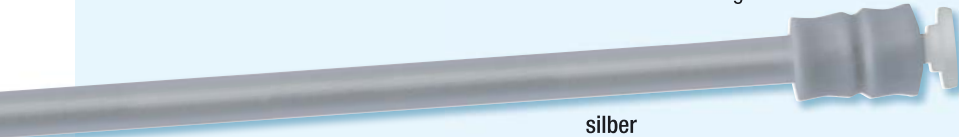

	<b>silber</b>	
610503	40 – 60 cm lang	20 Stück
610504	60 – 90 cm lang	20 Stück
610505	80 – 120 cm lang	20 Stück

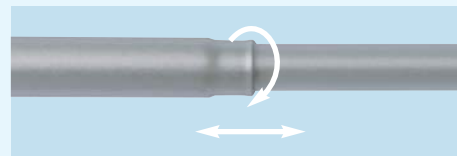

Raffinierte Dreh- und Klemmtechnik im Rohr



Endstücke mit flexiblen Puffern – auch für schräge Falze

## Klickstange für Fenster mit einer Rahmenstärke von 15 bis 20 mm

SB-verpackt à 1 Stück im Polybeutel

### Kugel

Rohr + Endstücke weiß, Halterungen weiß

730910	30 – 45 cm	Ø 10 mm	5 Stück
730911	45 – 60 cm	Ø 10 mm	5 Stück
730912	60 – 90 cm	Ø 10 mm	5 Stück
730913	90 – 140 cm	Ø 10 mm	5 Stück

Rohr + Endstücke nickel-matt, Halterungen weiß

730920	30 – 45 cm	Ø 10 mm	5 Stück
730921	45 – 60 cm	Ø 10 mm	5 Stück
730922	60 – 90 cm	Ø 10 mm	5 Stück
730923	90 – 140 cm	Ø 10 mm	5 Stück

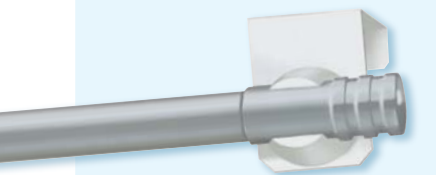
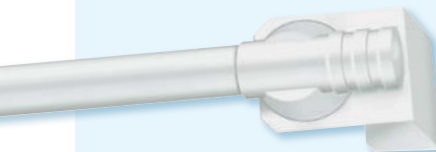
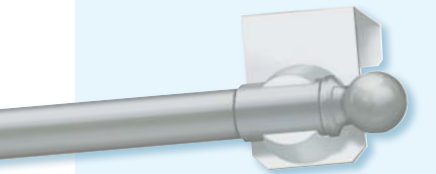
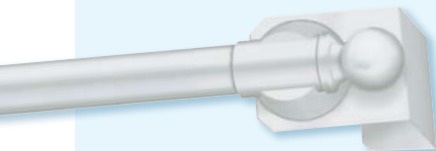

### Zylinder modern

Rohr + Endstücke weiß, Halterungen weiß

730940	30 – 45 cm	Ø 10 mm	5 Stück
730941	45 – 60 cm	Ø 10 mm	5 Stück
730942	60 – 90 cm	Ø 10 mm	5 Stück
730943	90 – 140 cm	Ø 10 mm	5 Stück

Rohr + Endstücke nickel-matt, Halterungen weiß

730950	30 – 45 cm	Ø 10 mm	5 Stück
730951	45 – 60 cm	Ø 10 mm	5 Stück
730952	60 – 90 cm	Ø 10 mm	5 Stück
730953	90 – 140 cm	Ø 10 mm	5 Stück

### Halter

SB-verpackt à 1 Paar im Polybeutel

730936	für Rahmenstärke 15 – 20 mm (Ersatz)	10 Paar
730933	für Rahmenstärke 10 – 15 mm (dünnere Fensterrahmen)	10 Paar
730934	für Rahmenstärke 18 – 23 mm (stärkere Fensterrahmen)	10 Paar



Art.-Nr.	Artikel-Bezeichnung	VE
<p><b>presto</b> SB-verpackt à 1 Stück im Polybeutel</p> <p><b>Rohr weiß, Endstücke Messing-massiv, poliert</b></p>		
730045 AV	30 – 40 cm Ø 10 mm	1 Stück
730080 AV	60 – 80 cm Ø 10 mm	1 Stück
730096 AV	95 – 130 cm Ø 12 mm	1 Stück
<p><b>Rohr weiß, Endstücke Messing-massiv, verchromt</b></p>		
730260 AV	40 – 60 cm Ø 10 mm	1 Stück
<p><b>Rohr weiß, Endstücke Aluminium lackiert, weiß</b></p>		
730320 AV	22 – 30 cm Ø 8 mm	1 Stück
<p><b>Rohr nickel-matt, Endstücke Aluminium eloxiert, nickel-matt</b></p>		
730445 AV	30 – 40 cm Ø 10 mm	1 Stück
730460 AV	40 – 60 cm Ø 10 mm	1 Stück
<p><b>Rohr vermessingt, Endstücke Aluminium, galvanisiert, poliert</b></p>		
730160 AV	40 – 60 cm Ø 10 mm	1 Stück
<p><b>presto BASIC</b> SB-verpackt à 1 Stück im Polybeutel</p> <p><b>weiß</b></p>		
730961	30 – 45 cm Ø 9 mm	5 Stück
730962	45 – 60 cm Ø 9 mm	5 Stück
730963	60 – 80 cm Ø 9 mm	5 Stück
<p><b>vermessingt</b></p>		
730971	30 – 45 cm Ø 9 mm	5 Stück
730972	45 – 60 cm Ø 9 mm	5 Stück
730973	60 – 80 cm Ø 9 mm	5 Stück
<p><b>presto modern</b> SB-verpackt à 1 Stück im Polybeutel</p> <p><b>Rohr weiß, Endstücke Aluminium, weiß</b></p>		
730645 AV	30 – 40 cm Ø 10 mm	1 Stück
730660 AV	40 – 60 cm Ø 10 mm	1 Stück
<p><b>Rohr nickel-matt, Endstücke Aluminium, nickel-matt</b></p>		
730745 AV	30 – 40 cm Ø 10 mm	1 Stück
730760 AV	40 – 60 cm Ø 10 mm	1 Stück
<p><b>Rohr chrom-satiniert, Endstücke Aluminium, chrom-satiniert</b></p>		
730845 AV	30 – 40 cm Ø 10 mm	1 Stück
730860 AV	40 – 60 cm Ø 10 mm	1 Stück
730880 AV	60 – 80 cm Ø 10 mm	1 Stück
730896 AV	100 – 130 cm Ø 12 mm	1 Stück
730030	Ersatz-Gummipuffer für »presto«-Stangen, weiß	10 Stück
<p><b>EXPAND</b> selbsthaftende Gardinenstange SB-verpackt à 1 Stück im Polybeutel</p> <p><b>weiß</b></p>		
730981	40 – 60 cm Ø 12 mm	5 Stück
730982	60 – 90 cm Ø 12 mm	5 Stück
730983	90 – 130 cm Ø 12 mm	5 Stück



# Klemmstangen

Art.-Nr. Artikel-Bezeichnung VE



## Klemm-Gardinenstange Aluminiumprofil, extra stabil

Weiß, flachoval 10 x 15 mm, ausziehbar, selbsthaftend, mit flexiblen Puffern zum Ausgleich angeschrägter Fensterholme

SB-verpackt à 1 Stück im Polybeutel



610123	27 – 40 cm	10 Beutel
610124	39 – 60 cm	10 Beutel
610126	56 – 90 cm	10 Beutel
610129	87 – 150 cm	10 Beutel

## pinn selbsthaftende Gardinenstange

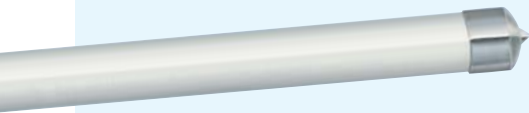

### Rohr weiß lackiert, Enden Aluminium verchromt

SB-verpackt à 1 Stück im Polybeutel



610401	25 – 30 cm	Ø 8 mm	10 Stück
610402	30 – 35 cm	Ø 8 mm	10 Stück
610403	35 – 45 cm	Ø 8 mm	10 Stück
610404	45 – 55 cm	Ø 8 mm	10 Stück
610405	50 – 65 cm	Ø 11 mm	10 Stück
610407	65 – 80 cm	Ø 11 mm	10 Stück
610408	80 – 95 cm	Ø 11 mm	10 Stück
610409	95 – 110 cm	Ø 11 mm	10 Stück
610411	110 – 125 cm	Ø 11 mm	10 Stück

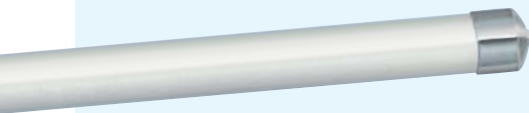

### Rohr weiß lackiert, Enden Aluminium verchromt

lose verpackt

110402	30 – 35 cm	Ø 8 mm	25 Stück
110403	35 – 45 cm	Ø 8 mm	25 Stück
110404	45 – 55 cm	Ø 8 mm	25 Stück
110405	50 – 65 cm	Ø 11 mm	25 Stück
110407	65 – 80 cm	Ø 11 mm	25 Stück
110408	80 – 95 cm	Ø 11 mm	25 Stück
110409	95 – 110 cm	Ø 11 mm	25 Stück
110411	110 – 125 cm	Ø 11 mm	25 Stück
110406 AV	60 – 70 cm	Ø 9 mm	25 Stück
110410 AV	100 – 115 cm	Ø 9 mm	25 Stück

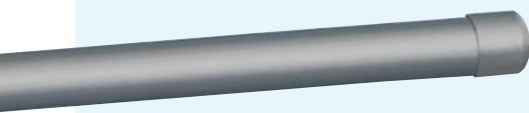

### Rohr nickel-matt, Enden Aluminium nickel-matt

SB-verpackt à 1 Stück im Polybeutel

610440	30 – 40 cm	Ø 8 mm	10 Stück
610441	40 – 50 cm	Ø 8 mm	10 Stück
610450	50 – 65 cm	Ø 11 mm	10 Stück
610451	65 – 80 cm	Ø 11 mm	10 Stück
610452	80 – 95 cm	Ø 11 mm	10 Stück
610453	95 – 110 cm	Ø 11 mm	10 Stück
610454	110 – 125 cm	Ø 11 mm	10 Stück



110401	Klebe-Fixpunkte für »pinn«-Stangen, weiß	100 Stück 
--------	------------------------------------------	-------------------------------------------------------------------------------------------------

Art.-Nr. Artikel-Bezeichnung VE

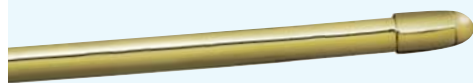

## Vitragenstange

rund 7 mm Ø,  
extra schwer, mit Metallendkappen, Schutzlackiert,  
lose verpackt, inkl. Schraubhaken

ausziehbar, 100% Innenlänge

### Eisen weiß

110130	40 cm lang		25 Stück
110131	60 cm lang		25 Stück
110132	80 cm lang		25 Stück

### Eisen vermessingt

110140	40 cm lang		25 Stück
110141	60 cm lang		25 Stück



## Vitragenstange

rund 7 mm Ø,  
Reinmessing, mit Kugel,  
lose verpackt, inkl. Schraubhaken

ausziehbar, 100% Innenlänge

### weiß

110164	40 cm lang		25 Stück
110165	60 cm lang		25 Stück
110166	80 cm lang		25 Stück
110167	100 cm lang		25 Stück



### messing-glanz

110160	40 cm lang		25 Stück
110161	60 cm lang		25 Stück
110162	80 cm lang		25 Stück
110163	100 cm lang		25 Stück

### nickel-glanz

110170	40 cm lang		25 Stück
110171	60 cm lang		25 Stück
110172	80 cm lang		25 Stück
110173	100 cm lang		25 Stück



### nickel-matt

110180	40 cm lang		25 Stück
110181	60 cm lang		25 Stück
110182	80 cm lang		25 Stück
110183	100 cm lang		25 Stück



## Vitragenstange

rund 7 mm Ø,  
Messingrohr mit Kugel, pulverbeschichtet,  
SB-verpackt à 1 Stück im Polybeutel, inkl. Schraubhaken

ausziehbar, 100% Innenlänge

### schwarz

110174	30 cm lang		10 Stück
110175	40 cm lang		10 Stück
110176	60 cm lang		10 Stück
110177	90 cm lang		10 Stück

Art.-Nr.

Artikel-Bezeichnung

VE



## California / Café - Stangen

12 mm Ø, ausziehbar





ohne Ringe, komplett mit kurzen und langen Trägern, zum Kleben oder Schrauben

SB-verpackt à 1 Stück im Polybeutel





### ausziehbar von 55 – 85 cm

730400	weiß		10 Stück
730500	vermessingt		10 Stück
730403	verchromt		10 Stück
730405	nickel-matt		10 Stück

### ausziehbar von 85 – 135 cm

730401	weiß		10 Stück
730501	vermessingt		10 Stück
730503	verchromt		10 Stück
730504	messing-matt		10 Stück
730505	nickel-matt		10 Stück

### ausziehbar von 135 – 225 cm

730402	weiß		10 Stück
730502	vermessingt		10 Stück
730603	verchromt		10 Stück
730604	messing-matt		10 Stück
730605	nickel-matt		10 Stück



## Klebepads

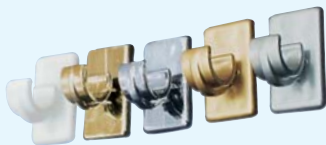

für California-Träger usw.

730415	beidseitig selbstklebend		100 Stück
--------	--------------------------	---------------------------------------------------------------------------------------	-----------



## California-Träger





kurze Ausführung (22 mm),  
mit Klebeplatte und Schrauben

520100	weiß		20 Stück
520102	messingfarbig		20 Stück
520103	chromfarbig		20 Stück
520104	messing-matt		20 Stück
520105	nickel-matt		20 Stück



## California-Träger



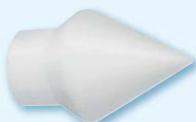

lange Ausführung (36 mm),  
mit Klebeplatte und Schrauben









520110	weiß		20 Stück
520112	messingfarbig		20 Stück
520113	chromfarbig		20 Stück
520114	messing-matt		20 Stück
520119	nickel-matt		20 Stück



## Atlanta-Endstück

für 12 mm Ø Stangen und California-Garnituren

520115	weiß		20 Stück
520117	messingfarbig		20 Stück
520118	chromfarbig		20 Stück
520124	messing-matt		20 Stück
520125	nickel-matt		20 Stück

Art.-Nr.	Artikel-Bezeichnung	VE
		
<b>Vitragestange, kunststoffummantelt</b> mit Kunststoffendknöpfen, 100 % Innenlänge, inkl. Schraubhaken		
lose verpackt		
110231 AV	120 cm lang weiß	50 Stück 
SB-verpackt à 2 Stück im Polybeutel		
610103	30 cm lang weiß	20 Beutel
610104	40 cm lang weiß	20 Beutel
610106	60 cm lang weiß	20 Beutel
610108	80 cm lang weiß	20 Beutel
610110	100 cm lang weiß	20 Beutel
610115	30 cm lang nickel-matt	20 Beutel
610116	40 cm lang nickel-matt	20 Beutel
610117	60 cm lang nickel-matt	20 Beutel
610118	80 cm lang nickel-matt	20 Beutel
610119	100 cm lang nickel-matt	20 Beutel
		
<b>Vitragestange, kunststoffbeschichtet</b> mit Kunststoffendknöpfen, 100 % Innenlänge, inkl. Schraubhaken		
lose verpackt		
110002	30 cm lang weiß	25 Stück
110003	40 cm lang weiß	25 Stück
110004	50 cm lang weiß	25 Stück
110005	60 cm lang weiß	25 Stück
110007	80 cm lang weiß	25 Stück
110008	100 cm lang weiß	25 Stück
110009	120 cm lang weiß	25 Stück
		
<b>Vitragestange SUPER, kunststoffummantelt, extra schwere Ausführung</b> mit Kunststoffendknöpfen, 100 % Innenlänge, inkl. Schraubhaken		
SB-verpackt à 2 Stück im Polybeutel		
610214	40 cm lang weiß	10 Beutel
610216	60 cm lang weiß	10 Beutel
610218	80 cm lang weiß	10 Beutel
		
<b>Scheibenstange 12 mm Ø</b>		
503180	<b>Stahlrohr, 12 mm Ø</b> kunststoffummantelt, weiß 1 Länge à 5,00 m * Verschnitt ist selbst einzukalkulieren.	5 m 25 m 50 m
126020	<b>Endstopfen</b> für 12 mm Ø Stahlrohr Kunststoff, weiß	100 Stück 
520115	<b>Atlanta-Endstück</b> für 12 mm Ø Kunststoff, weiß	20 Stück 
520100	<b>California-Träger</b> für 12 mm Ø kurze Ausführung (22 mm), mit Klebeplatte und Schrauben, Kunststoff, weiß	20 Stück 
503574	<b>Klebeträger</b> für 12 mm Ø Mittel- und Seitenträger, Kunststoff, weiß	50 Paar
520126	<b>Seitenlager</b> für 12 mm Ø mit Klebeplatte und Schrauben, Kunststoff, weiß	1 Paar

Art.-Nr. Artikel-Bezeichnung VE

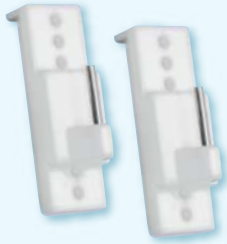

**Winkelklebehaken**, verstellbar  
zum Nachspannen und Korrigieren von Spanngardinen

110047 weiß 100 Stück



**Klebehaken**, mit Metallstift

110063	transparent		Größe: 19 x 28 mm	100 Stück
110053	weiß		Größe: 19 x 28 mm	100 Stück
110054	braun		Größe: 19 x 28 mm	100 Stück
110060	chrom		Größe: 20 x 30 mm	100 Stück
110061	gold		Größe: 20 x 30 mm	100 Stück

**Scheibenstangenhäkchen**  
2 x 25 mm, Holzgewinde

110051 verzinkt 100 Stück



**Klemmsystem-Bilderhaken mit Öse**



610090	weiß, für Kunststoff-Fenster	Rahmenstärke 12–19 mm	10 Paar
610091	weiß, für Alu-Fenster	Rahmenstärke 5–12 mm	10 Paar

**Fensterbild-Saughaken**  
rund, transparent, mit Haken



110049 Ø 20 x 25 mm 50 Stück

**Kipp-Regler**  
selbstklebend

Für die stufenweise Einstellung der Kippneigung des Fensters.  
Der Klemmträger wird am Fenster montiert, der Regler mit Doppel-Klebeband am Rahmen.



126179 weiß 10 Stück

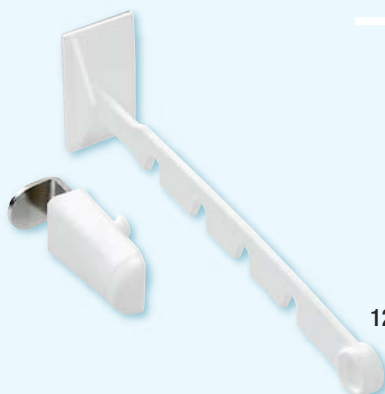

# Klemmträger

Art.-Nr.

Artikel-Bezeichnung

VE

## Deko-Klemmsystem

einfachste Montage an Kunststoff- oder Alu-Fensterrahmen, horizontal oder vertikal.

Zum Montage-Set gehören:  
2 Klemmträger,  
2 Montagewinkel mit Spannschraube und Abdeckkappe,  
3 Paar Ausgleichsstücke,  
2 Vitragenstangenhalter und  
2 Rundstangenhalter

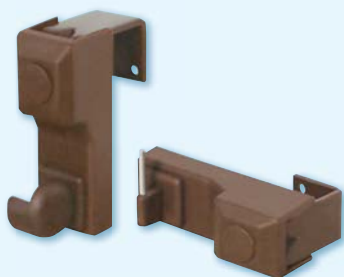

610060

für Kunststoff-Fenster von 12 bis 19 mm Rahmenstärke

weiß

10 Paar

610062

braun

10 Paar

610070

für Alu-Fenster von 6 bis 12 mm Rahmenstärke

weiß

10 Paar

610072

braun

10 Paar

## Universal-Klemmträger

Befestigung ohne Bohren und Festschrauben an Kunststoff- oder Alu-Fensterrahmen bis 28 mm Stärke, universell einsetzbar durch modularen Aufbau – ohne Adapter auch als Deko-Aufhänger.

- einfache Montage und Demontage
- wiederverwendbar
- UV-beständig
- zusätzliche Fixierung durch Klebeplättchen
- keine Beschädigung der Fensterflügel



für Deko



für Rohre

610085

mit 1 Paar Adaptern für Caféhausstangen oder Rohre 12 mm Ø

weiß

10 Paar



für Jalousie

für Plisse

610088

mit je 1 Paar Adaptern für Jalousieträger und Plisseeträger

weiß

10 Paar

100 Paar

## Klemmsystem-Plisse-Vorhangträger

(ohne Plisse-Deckenträger)



610095

weiß

für Kunststoff-Fenster

10 Paar

610096

weiß

für Alu-Fenster

10 Paar

610097

braun

für Kunststoff-Fenster

10 Paar

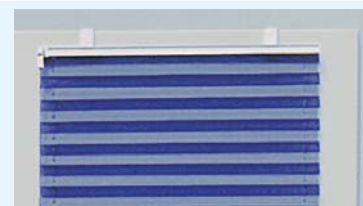

Art.-Nr. Artikel-Bezeichnung VE



## Klemmträger für Vitragen- und Caféhausstangen

Verwendung horizontal und vertikal möglich.  
Für Rahmenstärken von 5 bis 28 mm.

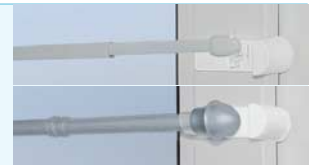

610220	weiß		10 Paar
610222	alu		10 Paar

## Vitragenclip zur Montage von Vitragenstangen im Fensterfalz

Befestigen Sie Ihre Vitragenstange im Fensterfalz ohne zu bohren.  
Der Clip wird zwischen Fensterglas und Gummidichtung montiert.  
Für Rechts- und Linksmontage.

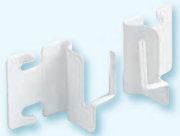

610230	weiß		10 Paar
			100 Paar

## Universalträger für alle gängigen Sonnenschutzprodukte

Zur Befestigung wird lediglich ein Schraubendreher benötigt. Für  
Kunststoff-, Holz- und Alu-Fenster mit Rahmenstärken von 4 bis 24 mm.



610225	weiß		10 Paar
610226	braun		10 Paar
610227	alu		10 Paar
610228	schwarz		10 Paar

## Klemmträger für Plisseeanlagen – mit Adapter für Decomatic® Spannschuhe

Träger mit besonders niedriger Bauhöhe, für Rahmenstärken von 4 bis 24 mm.  
Der transparente Adapter ermöglicht eine schnelle Montage der Spannschuhe ohne  
Werkzeug: er wird einfach aufgesteckt und um 90 Grad in den Träger gedreht.



610237	weiß		1 Satz = 4 Stück	1 Satz
610238	braun		1 Satz = 4 Stück	1 Satz
610239	schwarz		1 Satz = 4 Stück	1 Satz
610240	grau		1 Satz = 4 Stück	1 Satz

610241	<b>Adapter / Aufsteckhalter</b> transparent		1 Stück
--------	---------------------------------------------	--	---------

- als Ersatzteil für Klemmträger 610237-240
- als Zusatzoption für FalzFix 610233/234 und Glasclip 610235/236



## FalzFix Klemmträger für Plisseeanlagen

Die Höhenverstellung kann die unterschiedlichen Rahmenbreiten der  
Kunststofffenster ausgleichen. Für Rahmenstärken von 9 bis 25 mm.



610233	weiß		1 Satz = 4 Stück	10 Satz
610234 AV	braun		1 Satz = 4 Stück	1 Satz

## Glasclip zur Montage von Plisseeanlagen im Fensterfalz

Die Glasclips fassen zwischen Glasleiste und Scheibe.  
Ab 80 cm Breite bitte 3 Stück einsetzen.



610235	weiß		1 Satz = 4 Stück	10 Satz
610236	alu		1 Satz = 4 Stück	10 Satz

Art.-Nr. Artikel-Bezeichnung VE



## Klemm-Grundträger

Geeignet für Rahmenstärken von 10 bis 25 mm, Verwendung horizontal und vertikal möglich.

126560 weiß  10 Paar



## Vitragenstangenhalter

Scheiben-Gardinenhaken für Vitragenstangen zum Aufstecken auf den Klemm-Grundträger 126 560.

126532 weiß  10 Stück



## Seitenhalter

Seitenlager für Caféhausstangen und Rohre mit 12 mm Ø zum Aufstecken auf den Klemm-Grundträger 126 560.

126411 weiß  5 Paar



## Californiahalter

Halter für Caféhausstangen und Rohre mit 12 mm Ø zum Aufstecken auf den Klemm-Grundträger 126 560.

126712 weiß  10 Stück



## Glasfit-Leiste

selbstklebend, 1 Länge à 2,50 m

Zum Ausgleich schräger Glasleisten. Bei der Montage von Sonnenschutz muss nicht in den Rahmen gebohrt werden.

126180 weiß  12 Stück



## Stabhalter mit Halteplatte selbstklebend

Zur Arretierung des Wendestabes einer Jalousie.

126171 weiß  10 Stück



## Magnethalter

selbstklebend / anschraubbar

Ein starker Magnet hält die Unterleiste der Jalousie fest am Fensterrahmen. Sie können den Effekt einer Seitenführung / Pendelsicherung erzielen!

126175 weiß  10 Paar  
126176 braun  10 Paar





Art.-Nr. Artikel-Bezeichnung VE

## Plissee-Klebeplatten

Plissee-Klebeplatten halten auf Kunststoff- und Aluminiumfensterrahmen, welche nicht speziell beschichtet, gemasert, uneben oder rau sind, Glasleistentiefe mindestens 13 mm.

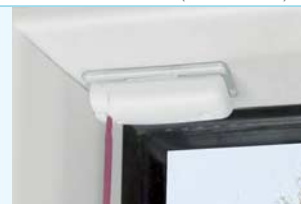

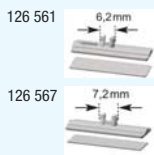

Anwendungsbeispiele



126561  
126567

für **Cosiflor®**

transparent  für Spannschuh aktuell (6,2mm) 1 Satz / 4 Stück  
transparent  für Spannschuh alt (7,2mm) 1 Satz / 4 Stück

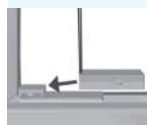

126562

für **Decomatic®**

transparent  1 Satz / 4 Stück



126563

**Universal** für **Cosiflor®** und **Decomatic®**

transparent  1 Satz / 4 Stück



## Plissee-Klebeträger

Für abgerundete oder schmale Glasleisten, z.B. bei Dreifachverglasung.



126564  
126565

**Universal** für **Cosiflor®** und **Decomatic®**

weiß  1 Satz / 4 Stück  
anthrazit  1 Satz / 4 Stück

## Schnellmontageclip für Kassettendecken

Geeignet für Profil-/ Schienenbreite 15 und 24 mm

Kein Bohren oder Schrauben, der Clip wird mittels Drehbewegung in die Rasterdeckenprofile geklemmt.



100528

weiß  10 Stück  
100 Stück

100529

**Rhombusmutter (Nutstein) und Schraube**  
für 6 mm Lauf, Schraube Seko M4 x 10 mm 10 Stück  
100 Stück

100532

**Rhombusmutter (Nutstein) einzeln**  
10,8 x 6,0 x 2,5 mm, M4 Gewinde 100 Stück

100534

**Senkkopfschraube einzeln**  
Kreuzschlitz PH2, DIN 965-4.8, M4 x 10 mm 100 Stück 

## Rohrschienenhalter

für 20er und 28er Rundprofile mit 6 mm Laufnut

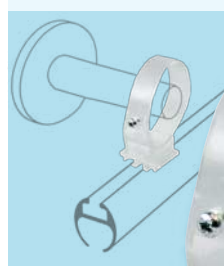

509136

wasserklar  10 Stück



# Gardinenringe

Art.-Nr. Artikel-Bezeichnung VE

## Gardinenringe

Kunststoff



Art.-Nr.	Artikel-Bezeichnung	Farbe	Material	VE
129648	8 / 13 mm	weiß	glasklar	100 Stück
129650	11 / 16 mm	weiß	glasklar	100 Stück
129655	13 / 18 mm	weiß	glasklar	100 Stück
129649	8 / 13 mm	glasklar	glasklar	100 Stück
129651	11 / 16 mm	glasklar	glasklar	100 Stück
129656	13 / 18 mm	glasklar	glasklar	100 Stück
129657	16 / 21 mm	glasklar	glasklar	100 Stück

## Messinghohlringe



Art.-Nr.	Artikel-Bezeichnung	Farbe	Material	VE
129666	11 / 16 mm	messing	messing	100 Stück
129661	13 / 18 mm	messing	messing	100 Stück
129662	18 / 23 mm	messing	messing	100 Stück
129664	30 / 39 mm	messing	messing	100 Stück
129665	37 / 49 mm	messing	messing	100 Stück
129675	11 / 16 mm	vernickelt	vernickelt	100 Stück
129676	13 / 18 mm	vernickelt	vernickelt	100 Stück
129662-1	18 / 23 mm	vernickelt	vernickelt	100 Stück

## Ringklammern



Art.-Nr.	Artikel-Bezeichnung	Farbe	Material	VE
130030	Eisen vernickelt, 22 mm Ø	vernickelt	Eisen	100 Stück
130031	Eisen vermessingt, 22 mm Ø	messing	Eisen	100 Stück
799330	Eisen schwarz, 27 mm Ø, schwere Ausführung	schwarz	Eisen	10 Stück
799340 AV	Eisen vermessingt, 27 mm Ø, schwere Ausführung	messing	Eisen	10 Stück

## Ringe

Kunststoff, mit Faltenleggehaken



503080	32 / 20 mm	weiß	Kunststoff	1 Blister à 8 Stück
sz2978206	56 / 40 mm	weiß	Kunststoff	1 Stück

# Haken

Art.-Nr. Artikel-Bezeichnung VE



## Faltenlegghaken

**bü844-** **Öse ca. 3 mm Ø** empfohlen für Flachringe mit Kunststoffeinlage   
-57 schwarz / -24 gold / -70 braun / -29 silber / -00 transparent 100 Stück

**129680** **Öse ca. 4,5 mm Ø** empfohlen für Flachringe mit Kunststoffeinlage   
natur 100 Stück   
**129681** weiß 100 Stück   
**129684** schwarz 100 Stück   
**129683** wasserklar 100 Stück

**505501** **Öse ca. 5 mm Ø** empfohlen für Vollmessingringe   
weiß 100 Stück   
**505505** schwarz 100 Stück   
**505503** natur 100 Stück   
**505504** silber 100 Stück   
**505502** wasserklar 100 Stück

**507508** **Öse ca. 6 mm Ø** empfohlen für 12er Kunststoffringe   
weiß 100 Stück   
**507507** schwarz 100 Stück   
**507506** wasserklar 100 Stück

**503400** **Öse ca. 7 mm Ø** empfohlen für 12er Holzringe   
weiß 100 Stück   
**503304** schwarz 100 Stück   
**503404** kiefer / eiche hell 100 Stück   
**503604** eiche rustikal 100 Stück   
**503704** silber 100 Stück   
**507504** glasklar 100 Stück   
**507606** wasserklar 100 Stück

**508004** **Öse ca. 9 mm Ø** empfohlen für 28er Stilringe   
weiß 100 Stück   
**507004** schwarz 100 Stück   
**508404** kiefer / eiche hell 100 Stück   
**504004** eiche rustikal 100 Stück   
**508504** nussbaum / braun / mahagoni 100 Stück   
**504304** silber 100 Stück   
**507404** glasklar 100 Stück

**506305** **Öse ca. 12 mm Ø** empfohlen für 35er Stilringe   
weiß 100 Stück   
**506404** kiefer / eiche hell 100 Stück   
**506604** eiche rustikal 100 Stück   
**506504** nussbaum / braun / mahagoni 100 Stück   
**506304** wasserklar 100 Stück

## Überklipshaken Öse 7 mm Ø

**129670** weiß 100 Stück   
**129673** schwarz 100 Stück   
**129672** glasklar 100 Stück

## Quer-Ösenhaken Öse 6 mm Ø

**503104** glasklar 100 Stück

## Gardinen-Donauklammern

**130013** 16 mm Ø, Eisen vermessingt 100 Stück   
**130014** 16 mm Ø, Eisen weiß 100 Stück   
**130019** 16 mm Ø, Eisen chromfarbig 100 Stück   
**130022** 22 mm Ø, Eisen vermessingt 100 Stück   
**130023** 22 mm Ø, Eisen weiß 100 Stück   
**130016** 33 mm Ø, Eisen vermessingt 100 Stück   
**130017** 33 mm Ø, Eisen weiß 100 Stück   
**130012** 16 mm Ø, Messing 100 Stück

## Karabinerhaken, vernickelt, weitere Ausführungen auf Seite D 19

**130056** 20 mm 100 Stück   
**130055** 25 mm 100 Stück   
**130054** 30 mm 100 Stück   
**130057** 40 mm 100 Stück

Art.-Nr. Artikel-Bezeichnung VE

## Schleuderstab

weiß, kunststoffummantelt, 5 mm Ø

111001	50 cm lang	25 Stück
111002	75 cm lang	25 Stück
111003	100 cm lang	25 Stück
111004	125 cm lang	25 Stück
111005	150 cm lang	25 Stück
111006	175 cm lang	10 Stück
111007	200 cm lang	10 Stück



## Schleuderstab

Plexiglas, ohne Quaste

111026	75 cm lang	8 mm Ø	50 Stück
111027	100 cm lang	9 mm Ø	50 Stück
111028	125 cm lang	10 mm Ø	50 Stück
111029	150 cm lang	10 mm Ø	50 Stück



## Schleuderstab

Plexiglas, mit Quaste

111036	75 cm lang	8 mm Ø	25 Stück
111037	100 cm lang	9 mm Ø	25 Stück
111038	125 cm lang	10 mm Ø	25 Stück
111039	150 cm lang	10 mm Ø	25 Stück



## Schleuderstab OKTAGON

Aluminium achteckig, 11 mm Ø

weiß matt

111305	75 cm lang	1 Stück
111306	100 cm lang	1 Stück
111307	125 cm lang	1 Stück
111308	150 cm lang	1 Stück



schwarz matt

111420	75 cm lang (ehem. 111309)	1 Stück
111421	100 cm lang (ehem. 111310)	1 Stück
111422	125 cm lang (ehem. 111311)	1 Stück
111423	150 cm lang (ehem. 111312)	1 Stück



## Schleuderstab AV

ME-Rohr, 9 mm Ø

Messing vernickelt

111108 AV	100 cm lang	1 Stück
111110 AV	150 cm lang	1 Stück



messing

111119 AV	125 cm lang	1 Stück
111120 AV	150 cm lang	1 Stück

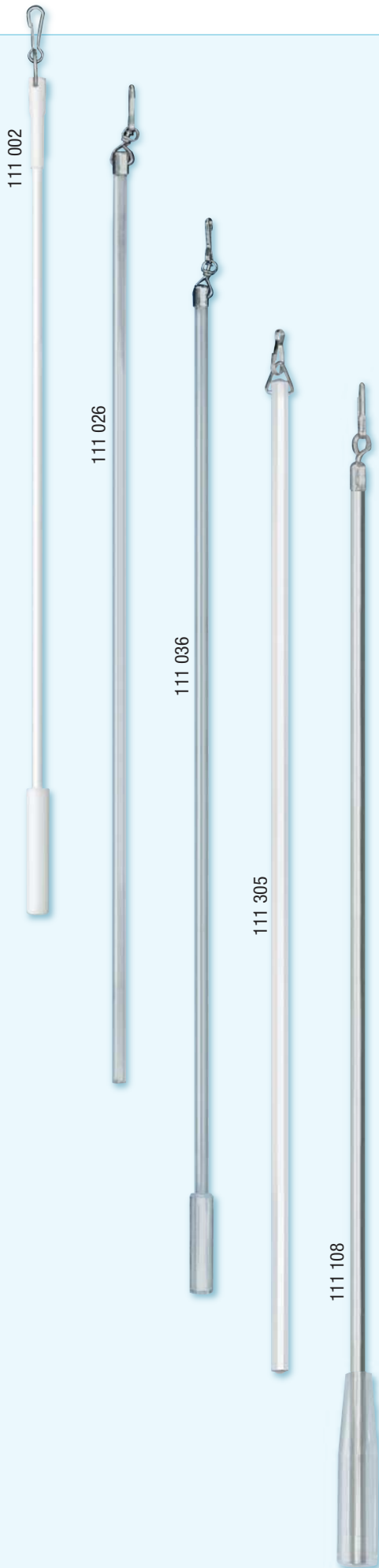

Art.-Nr. Artikel-Bezeichnung VE

## Schleuderstab *AluED*

Aluminium, 8 mm Ø, Hartgummi-Quaste

Stäbe nachträglich kürzbar, individuelle Längen bis 300 cm auf Anfrage.

### weiß

111320	75 cm lang		1 Stück
111321	100 cm lang		1 Stück
111322	125 cm lang		1 Stück
111323	150 cm lang		1 Stück
111324	200 cm lang		1 Stück

### silber

111330	75 cm lang		1 Stück
111331	100 cm lang		1 Stück
111332	125 cm lang		1 Stück
111333	150 cm lang		1 Stück
111334	200 cm lang		1 Stück

### schwarz

111370	75 cm lang		1 Stück
111371	100 cm lang		1 Stück
111372	125 cm lang		1 Stück
111373	150 cm lang		1 Stück
111374	200 cm lang		1 Stück

### bronze

111390	75 cm lang		1 Stück
111391	100 cm lang		1 Stück
111392	125 cm lang		1 Stück
111393	150 cm lang		1 Stück
111394	200 cm lang		1 Stück

### gold

111410	75 cm lang		1 Stück
111411	100 cm lang		1 Stück
111412	125 cm lang		1 Stück
111413	150 cm lang		1 Stück
111414	200 cm lang		1 Stück

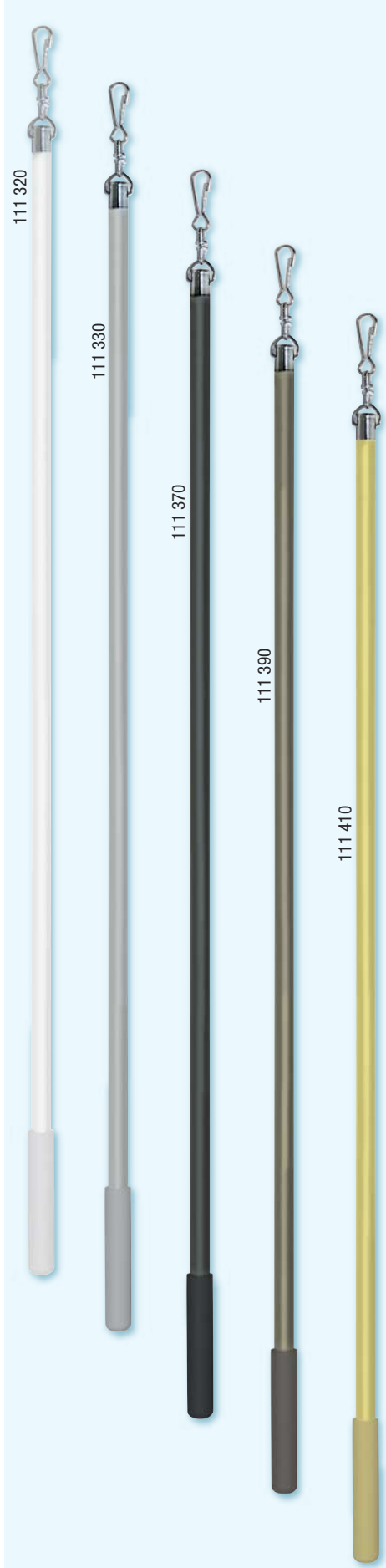

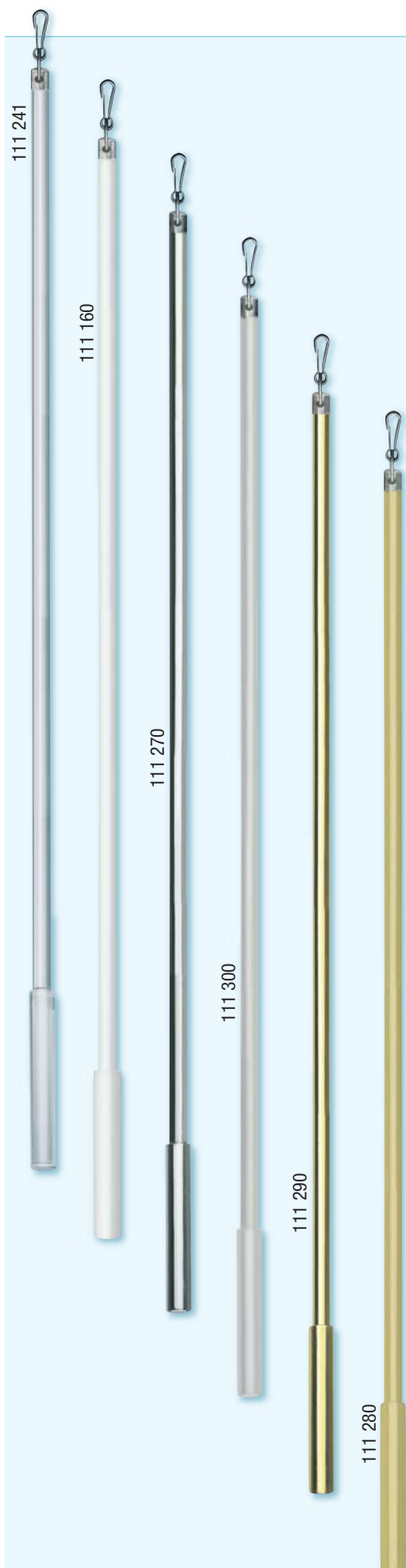

Art.-Nr. Artikel-Bezeichnung VE

## Schleuderstab

Kunststoff transparent, 10 mm Ø

111241	100 cm lang		10 Stück
111242	125 cm lang		10 Stück
111243	150 cm lang		10 Stück

## Stahl-Schleuderstab

weiß, kunststoffummantelt, 10 mm Ø

111160	75 cm lang		10 Stück
111170	100 cm lang		10 Stück
111180	125 cm lang		10 Stück
111180-1	150 cm lang		10 Stück
111180-2	200 cm lang		10 Stück

## Metall-Schleuderstab

edelstahl, galvanisiert, 10 mm Ø

111260 AV	75 cm lang		10 Stück
111261 AV	100 cm lang		10 Stück
111262 AV	125 cm lang		10 Stück

## Metall-Schleuderstab

chrom, galvanisiert, 10 mm Ø

111270	75 cm lang		10 Stück
111271	100 cm lang		10 Stück
111272	125 cm lang		10 Stück
111273	150 cm lang		10 Stück

## Metall-Schleuderstab

alu-natur, galvanisiert, 10 mm Ø

111300	75 cm lang		10 Stück
111301	100 cm lang		10 Stück
111302	125 cm lang		10 Stück
111303	150 cm lang		10 Stück

## Metall-Schleuderstab

messing-glanz, galvanisiert, 10 mm Ø

111290	75 cm lang		10 Stück
111291	100 cm lang		10 Stück
111292	125 cm lang		10 Stück
111293	150 cm lang		10 Stück
111294	200 cm lang		10 Stück

## Metall-Schleuderstab

messing-matt, galvanisiert, 10 mm Ø

111280	75 cm lang		10 Stück
111281	100 cm lang		10 Stück
111282	125 cm lang		10 Stück
111283	150 cm lang		10 Stück



Art.-Nr. Artikel-Bezeichnung VE

## Aluminium-Schleuderstab FUTURE

mit geriffeltem Griff, 9 mm Ø

### alu-matt

111061	75 cm lang		10 Stück
111062	100 cm lang		10 Stück
111063	125 cm lang		10 Stück
111064	150 cm lang		10 Stück

### weiß

111065	75 cm lang		10 Stück
111066	100 cm lang		10 Stück
111067	125 cm lang		10 Stück
111068	150 cm lang		10 Stück

## Aluminium-Schleuderstab

alu-natur, mit Endkappe 9 mm Ø

111220	100 cm lang		10 Stück
--------	-------------	------------------------------------------------------------------------------------	----------

## Messing-Schleuderstab

titan, mit Zylindergriff, 9 mm Ø

111230	100 cm lang		10 Stück
--------	-------------	--------------------------------------------------------------------------------------	----------

## Acrylglas-Schleuderstab

ohne Quaste

### glasklar

111200	100 cm lang, 12 mm Ø		10 Stück
111216	125 cm lang, 15 mm Ø		10 Stück
111218	150 cm lang, 15 mm Ø		10 Stück

### satiné

111210	100 cm lang, 12 mm Ø		10 Stück
111217	125 cm lang, 15 mm Ø		10 Stück
111219	150 cm lang, 15 mm Ø		10 Stück



Art.-Nr. Artikel-Bezeichnung VE



## PRISMA

Plexiglas-Quaste  
ca. 140 cm lang

111070	weiß	1 Stück
111071	creme	1 Stück

111070

111071



## KEGEL

Quaste mit umwickelter Kordel  
ca. 140 cm lang

111072	weiß	1 Stück
111073	creme	1 Stück

111072

111073



## PERLEN

Perlen-Quaste mit Drahtseil  
ca. 77 cm lang

111074	graubraun	1 Stück
--------	-----------	---------

111074

111075

## HOLZ

Holz-Quaste mit schwarzer Kordel  
ca. 127 cm lang

111075	dunkelbraun	1 Stück
--------	-------------	---------



Gardinenspirale mit Haken



Gardinenspirale mit Endknopf und offenem Haken

## ED-Gardinenspirale

- Für die Gardinenbefestigung in Campingmobilen und Booten
- Als Alternative zur Vitragenstange, insbesondere bei überbreiten Fenstern
- Für den Einsatz bei der Wintergartenbeschattung
- Für viele weitere Anwendungen, z.B. als Beschwerung oder Schleuderstab



## ED Gardinenspirale

110300 kunststoffummantelter Spiraldraht, 4 mm Ø, weiß 30 Meter 120 Meter

## Haken für Gardinenspirale



130040 **Haken offen** Ringauge innen: 6,0 mm Ø, 20 mm lang, glanzverzinkt 200 Stück



130042 **Haken offen** Ringauge innen: 8,0 mm Ø, 40 mm lang, glanzverzinkt 100 Stück



130041 **Haken geschlossen** Ringauge innen: 6,5 mm Ø, glanzverzinkt 200 Stück



130043 **Endknopf für Gardinenspirale** weiß 1 VE  
VE = 4 Eindrehknöpfe + 4 Haken (offen, 40 mm lang)



110051 **Winkelschraubhaken** 2 x 25 mm verzinkt 100 Stück



110053 **Klebehaken**, mit Metallstift Größe: 19 x 28 mm, weiß 100 Stück



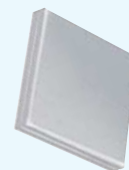
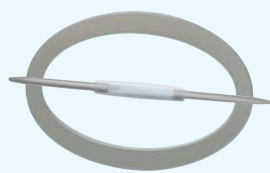

## Raff-Deko

ab Seite D 386



## Raff-Accessoires

ab Seite D 390



## Gardinenbänder

ab Seite D 399



## Bügeleinlagen | Schlaufengleiter

ab Seite D 408

Art.-Nr.

Artikel-Bezeichnung

VE

## Deko-Kunststoffspange mit Stab

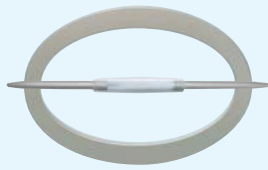

### Ovalring

Innenmaß 170 x 100 mm

1 Stück

792201-17 chrom matt  
792201-18 edelstahl  
792201-19 messing matt

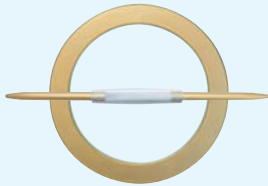

### Rundring

Innenmaß 120 mm Ø

1 Stück

792202-17 chrom matt  
792202-18 edelstahl  
792202-19 messing matt



### Kunststoff-Stab

Länge verstellbar, 180 – 240 mm

1 Stück

791200-17 chrom matt  
791200-18 edelstahl  
791200-19 messing matt



Art.-Nr.

Artikel-Bezeichnung

VE



## CUFF Raffhalter / Manschette

Metall klappbar mit Feder / Scharnier

Durchmesser geschlossen: 5,5 bis 8,5 cm

711756 AV

altmessing



1 Stück

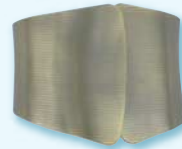

## HEART Raffhalter / Magnet

Holz (Höhe ca. 6 cm) mit Magnet und Schnur

Schnurlänge ca. 23 cm

711757  
711758

weiß  
altgrau



1 Stück  
1 Stück



Art.-Nr.

Artikel-Bezeichnung

VE



## Raffquaste mit Perlen

Quaste, verziert mit zwei perlmuttfarbenen Kugeln und kleinen Kristallsteinen.

Spannweite: ca. 70 cm  
Quastenlänge: 17 cm

711362  
711363

schwarz  
bordeaux



1 Stück  
1 Stück



## Schlüsselquaste

Länge: ca. 20 cm  
Quastenlänge: 13 cm

711364  
711365  
711366  
711367

creme  
beige  
schwarz  
bordeaux



1 Stück  
1 Stück  
1 Stück  
1 Stück



## Raffquaste Globe

Quaste mit transparenter Kugel

Spannweite: ca. 65 cm  
Quastenlänge: 20 cm

711370

schwarz



1 Stück



## Schlüsselquaste Globe

Quaste mit transparenter Kugel

Länge: ca. 20 cm  
Quastenlänge: 11 cm

711371  
711372  
711373

grau  
anthrazit  
schwarz



1 Stück  
1 Stück  
1 Stück



## Raffquaste mit metallischem Akzent

Spannweite: ca. 75 cm  
Quastenlänge: 17 cm

711737  
711739

bordeaux  
schwarz



1 Stück  
1 Stück

Art.-Nr. Artikel-Bezeichnung VE



## Raffquaste »ROPE«

Spannweite: ca. 80 cm  
 Quaste: 17 cm / 4 cm Ø  
 30% Acryl / 70% Baumwolle

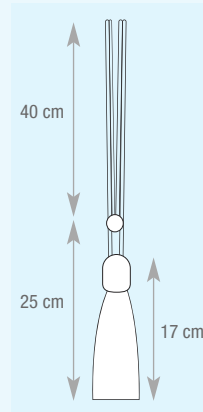

711795	schwarz		1 Stück
711796	beige		6 Stück
711797	anthrazit		1 Stück
711798	leinen		6 Stück



## Dekospange »ROPE«

Stab: Bambus 24 cm  
 Korde: 84% Acryl / 16% Baumwolle

711790	schwarz		1 Stück
711791	beige		6 Stück
711792	anthrazit		1 Stück
711793	leinen		6 Stück

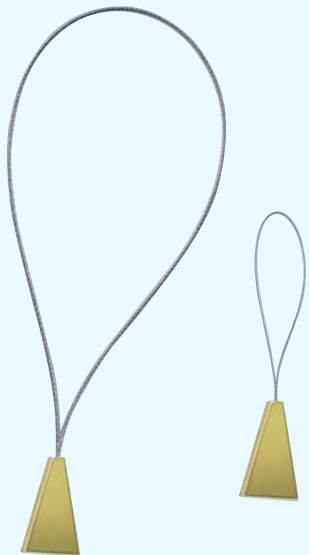

## Magnet-Raffhalter mit NIRO-Seil

Seil ca. 60 cm lang

670533 AV	<b>Dreieck</b> , metallisiert 45 x 25 mm messing-matt Optik	1 Stück
-----------	----------------------------------------------------------------	---------

## Magnethalter mit NIRO-Seil

Seil ca. 20 cm lang

670523 AV	<b>Dreieck</b> , metallisiert 45 x 25 mm messing-matt Optik	6 Stück
-----------	----------------------------------------------------------------	---------



Art.-Nr. Artikel-Bezeichnung VE

## Magnet-Deko-Doppelknöpfe

Kunststoff, 2 Paar im Blister

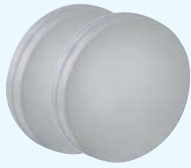

611620	<b>Rund</b> 28 mm Ø		10 Blister
611621	chrom-glanz		
611622	messing-glanz		10 Blister
611623	chrom-matt		10 Blister
611623	messing-matt		10 Blister
611628	weiß		10 Blister
611624	granit		10 Blister
611625	edelstahl		10 Blister
611626	bronziert		10 Blister
611627	messing-antik		10 Blister



611675	<b>Rund</b> 45 mm Ø		10 Blister
611673	edelstahl		
611673	messing-matt		10 Blister
611678	weiß		10 Blister



611655	<b>4-Eck</b> 28 x 28 mm		10 Blister
611653	edelstahl		
611653	messing-matt		10 Blister

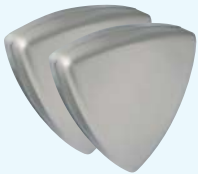

611665	<b>3-Eck</b> 39 mm		10 Blister
611663	edelstahl		
611663	messing-matt		10 Blister

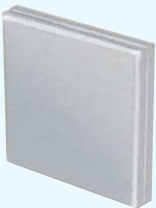

## Magnet-Deko-Griffstück

Aluminium, 1 Paar

611680	<b>4-Eck</b> 40 x 40 mm		1 Paar
611681	silber, glänzend		
611681	silber, matt satiniert		1 Paar
611682	weiß		1 Paar

ab je 10 Paar 10% Rabatt



## Zierhalter mit Deko-Magnet

Motiv »Spirale«, ca. 95 mm Ø

513872	vermessingt		10 Stück
513875	messing-matt		10 Stück

## Deko-Magnet

8 mm Ø

110066	silber		10 Stück
--------	--------	--	----------



## Deko-Magnet mit Öse

8 mm Ø, 2-teiliger Satz

711399 AV	silber		4 Satz im Blister	1 Blister
-----------	--------	--	-------------------	-----------



# Raffbügel

Art.-Nr. Artikel-Bezeichnung VE

## Messing-Raffbügel

Gesamtlänge ca. 175 mm  
Wandabstand ca. 60 mm

470020 messing-glanz  1 Stück



## Messing-Raffarm

ca. 300 mm lang, schwenkbar

470027 messing-glanz  1 Stück

470030 nickel-matt  1 Stück



# Raffrosetten

Art.-Nr. Artikel-Bezeichnung VE

## Messing-Raffrosette

ca. 75 mm Ø, Wandabstand 80 mm



490006	messing-glanz		mit Zubehör	1 Stück
490906	messing-matt		mit Zubehör	1 Stück
490406	nickel-matt		mit Zubehör	1 Stück
490106	bronziert		mit Zubehör	1 Stück
490506	messing-glanz		ohne Zubehör	1 Stück
490806	messing-matt		ohne Zubehör	1 Stück
490206	nickel-matt		ohne Zubehör	1 Stück
490606	bronziert		ohne Zubehör	1 Stück

## Messing-Raffrosette

ca. 50 mm Ø, Wandabstand 80 mm, komplett mit Zubehör



491007 AV	messing-glanz			1 Stück
491507 AV	messing-matt			1 Stück
491607 AV	nickel-matt			1 Stück

## Messing-Raffrosette

ca. 50 mm Ø, Wandabstand 80 mm



761487	messing-glanz		mit Zubehör	1 Stück
761587	messing-matt		mit Zubehör	1 Stück
761987	nickel-matt		mit Zubehör	1 Stück
761387	bronziert		mit Zubehör	1 Stück
761488	messing-glanz		ohne Zubehör	1 Stück
761588 AV	messing-matt		ohne Zubehör	1 Stück
761988	nickel-matt		ohne Zubehör	1 Stück

## Messing-Endkugel, massiv

ca. 30 mm Ø mit M 6 Gewinde, ohne Rosettenhalter



410081 AV	messing-glanz		ohne Zubehör	10 Stück
410181 AV	messing-matt		ohne Zubehör	10 Stück
410381 AV	nickel-matt		ohne Zubehör	10 Stück
410581 AV	bronziert		ohne Zubehör	10 Stück

## Messing-Rosette, massiv

ca. 35 mm Ø mit M 6 Gewinde, ohne Rosettenhalter



750101	messing-glanz		ohne Zubehör	10 Stück
750301	messing-matt		ohne Zubehör	10 Stück
750601	nickel-matt		ohne Zubehör	10 Stück

Art.-Nr. Artikel-Bezeichnung VE

## Messing-Verlängerungsstück



	10 mm Ø, 50 mm lang, mit Gewindestück M6		
710021	messing-glanz		10 Stück
710621	messing-matt		10 Stück
710721	nickel-matt		10 Stück
710121	bronziert		10 Stück

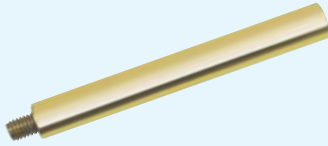

	10 mm Ø, 80 mm lang, mit Gewindestück M6		
710022	messing-glanz		10 Stück
710622	messing-matt		10 Stück
710722	nickel-matt		10 Stück
710122	bronziert		10 Stück

## Messing-Verlängerungsstück



	16 mm Ø, 43 mm lang, mit Gewindestück M6		
410021	messing-glanz		10 Stück
410621	messing-matt		10 Stück
410721	nickel-matt		10 Stück
410121	bronziert		10 Stück



	16 mm Ø, 85 mm lang, mit Gewindestück M6		
410022	messing-glanz		10 Stück
410622	messing-matt		10 Stück
410722	nickel-matt		10 Stück
410122	bronziert		10 Stück

## S-Haken



	18 mm Ø		
410024	vermessingt		100 Stück
410125	chrom		100 Stück

## S-Haken

	10 mm Ø		
410037	vermessingt		100 Stück
410036	chrom		100 Stück

## Gewindestück



117107	M 5 auf M 6	25 mm lang	50 Stück
--------	-------------	------------	----------

## Gewindestift



117104	M 4 x 58 mm		50 Stück
117106	M 5 x 42 mm		50 Stück
410026	M 6 x 18 mm		100 Stück
117103	M 6 x 50 mm		50 Stück

## Stockschraube



410033	M 4 x 40 mm	100 Stück
410034	M 5 x 50 mm	100 Stück
410025	M 6 x 60 mm	100 Stück
410027	M 6 x 120 mm	10 Stück
410038	M 8 x 80 mm	50 Stück

Art.-Nr.

















Artikel-Bezeichnung

VE



## Messing-Rosettenhalter rund

mit Stockschraube,  
für Rosetten mit M6 Gewinde





417091	messing-glanz		100 mm	10 Stück
417092	messing-glanz		150 mm	10 Stück
417093	messing-glanz		200 mm	10 Stück
417094	messing-glanz		250 mm	10 Stück
417095	messing-glanz		300 mm	10 Stück
417791	messing-matt		100 mm	10 Stück
417792	messing-matt		150 mm	10 Stück
417793	messing-matt		200 mm	10 Stück
417794	messing-matt		250 mm	10 Stück
417691	nickel-matt		100 mm	10 Stück
417692	nickel-matt		150 mm	10 Stück
417693	nickel-matt		200 mm	10 Stück
417694	nickel-matt		250 mm	10 Stück
417191	bronziert		100 mm	10 Stück
417192	bronziert		150 mm	10 Stück
417193	bronziert		200 mm	10 Stück
417194	bronziert		250 mm	10 Stück



## Messing-Winkel

mit Senkschraube zum Anschrauben beliebiger Raffrosetten,  
Lieferung ohne Rosette

120 x 80 mm

470010	messing-glanz		1 Stück
470320	messing-matt		1 Stück
470310	nickel-matt		1 Stück
470330	bronziert		1 Stück



## Messing-Raffarm

aus biegefähigem Material

messing-glanz 

470001	Ausladung 160 mm, Wandabstand 70 mm	1 Stück
470002	Ausladung 270 mm, Wandabstand 80 mm	1 Stück

messing-matt 

470301	Ausladung 160 mm, Wandabstand 70 mm	1 Stück
470302	Ausladung 270 mm, Wandabstand 80 mm	1 Stück

nickel-matt 

470101	Ausladung 160 mm, Wandabstand 70 mm	1 Stück
470102	Ausladung 270 mm, Wandabstand 80 mm	1 Stück

Art.-Nr. Artikel-Bezeichnung VE

## Messing-Raffhaken 6-kant mit Stockschraube, S-Haken und Rosette



442100	messing-glanz		100 mm	10 Stück
442150	messing-glanz		150 mm	10 Stück
442200	messing-glanz		200 mm	10 Stück
442250	messing-glanz		250 mm	10 Stück
448100	messing-matt		100 mm	10 Stück
448150	messing-matt		150 mm	10 Stück
448200	messing-matt		200 mm	10 Stück
448250	messing-matt		250 mm	10 Stück
447100	nickel-matt		100 mm	10 Stück
447150	nickel-matt		150 mm	10 Stück
447200	nickel-matt		200 mm	10 Stück
447250	nickel-matt		250 mm	10 Stück
445100	bronziert		100 mm	10 Stück
445150	bronziert		150 mm	10 Stück
445200	bronziert		200 mm	10 Stück
445250	bronziert		250 mm	10 Stück
446100	weiß		100 mm	10 Stück
446150	weiß		150 mm	10 Stück
446200	weiß		200 mm	10 Stück
446250	weiß		250 mm	10 Stück

## Messing-Raffhaken rund mit Stockschraube



480080	messing-glanz		80 mm	10 Stück
480100	messing-glanz		100 mm	10 Stück
480120	messing-glanz		120 mm	10 Stück
480160	messing-glanz		160 mm	10 Stück
480200	messing-glanz		200 mm	10 Stück
480250	messing-glanz		250 mm	10 Stück
480300	messing-glanz		300 mm	10 Stück
480083	messing-matt		80 mm	10 Stück
480103	messing-matt		100 mm	10 Stück
480123	messing-matt		120 mm	10 Stück
480163	messing-matt		160 mm	10 Stück
480203	messing-matt		200 mm	10 Stück
480253	messing-matt		250 mm	10 Stück
480303	messing-matt		300 mm	10 Stück
480082	nickel-matt		80 mm	10 Stück
480102	nickel-matt		100 mm	10 Stück
480122	nickel-matt		120 mm	10 Stück
480162	nickel-matt		160 mm	10 Stück
480202	nickel-matt		200 mm	10 Stück
480252	nickel-matt		250 mm	10 Stück
480302	nickel-matt		300 mm	10 Stück
480085	bronziert		80 mm	10 Stück
480105	bronziert		100 mm	10 Stück
480125	bronziert		120 mm	10 Stück
480165	bronziert		160 mm	10 Stück
480205	bronziert		200 mm	10 Stück
480255	bronziert		250 mm	10 Stück
480305	bronziert		300 mm	10 Stück
480088	weiß		80 mm	10 Stück
480108	weiß		100 mm	10 Stück
480128	weiß		120 mm	10 Stück
480168	weiß		160 mm	10 Stück
480208	weiß		200 mm	10 Stück
480258	weiß		250 mm	10 Stück
480308	weiß		300 mm	10 Stück

# Raffhaken

Art.-Nr.	Artikel-Bezeichnung	VE
<b>Kunststoff-Raffhaken</b>		
	selbstklebend	
480385	messing-metallisiert 	100 Stück
480387	weiß 	100 Stück
<b>Messing-Raffhaken</b>		
	Hakenhöhe ca. 27 mm, mit Stahlstift	
480375	poliert 	100 Stück
	Ersatznagel für Raffhaken: Art.-Nr. 130 260 – siehe unten	
<b>Messing-Raffhaken</b>		
	Hakenhöhe ca. 30 mm, Wandabstand 25 mm	
480350	blank-gerollt 	100 Stück
480351	vernickelt 	100 Stück
480354	nickel-matt 	100 Stück
480353	weiß 	100 Stück
<b>Messing-Raffhaken</b>		
	Hakenhöhe ca. 38 mm, Wandabstand 31 mm	
480360	blank-gerollt 	100 Stück
480364	nickel-matt 	100 Stück
<b>Stahlbildernagel</b>		
		
130220	20 mm lang, mit überzogenem Messingkopf	100 Stück
130230	30 mm lang, mit überzogenem Messingkopf	100 Stück
130240	40 mm lang, mit überzogenem Messingkopf	100 Stück
130250	50 mm lang, mit überzogenem Messingkopf	100 Stück
	<b>brüniert</b>	
130226	26 mm lang, mit überzogenem Messingkopf	100 Stück
		
130263	2,0 x 25 mm, silberfarben	100 Stück
130264	2,7 x 30 mm, silberfarben	100 Stück
<b>Senkkopf-Schraube für Raffhaken</b>		
		
130866	3,0 x 25 mm, Edelstahl rostfrei	200 Stück
<b>Stahlstift / Bildernagel (Liko)</b>		
		
130260	1,4 x 26 mm, vermessingt	100 Stück
130266	2,3 x 25 mm, vermessingt	100 Stück
<b>Stahlnagel, blau</b>		
		
130619	2,0 x 16 mm	1.000 Stück
130625	2,0 x 25 mm	1.000 Stück
130640	2,5 x 40 mm	1.000 Stück
130650	2,5 x 50 mm	1.000 Stück

Art.-Nr. Artikel-Bezeichnung VE



**Messing-Rosettenhaken**  
mit Stockschraube  
Rosettendurchmesser ca. 35 mm  
Wandabstand ca. 35 mm

481081  
481381

messing-glanz  
weiß



25 Stück  
25 Stück



**Messing-Zierhaken**  
Hakenhöhe ca. 38 mm  
Wandabstand ca. 20 mm

482010

messing-glanz



  
50 Stück



**Messing-Zierhaken**  
Hakenhöhe ca. 40 mm  
Wandabstand ca. 20 mm

482011  
482511  
482111  
482311

messing-glanz  
nickel-matt  
bronziert  
weiß



  
50 Stück  
50 Stück  
50 Stück  
50 Stück



**Messing-Zierhaken**  
Hakenhöhe ca. 50 mm  
Wandabstand ca. 25 mm

482012  
482813  
482112  
482613

messing-glanz  
nickel-matt  
bronziert  
weiß



  
50 Stück  
50 Stück  
50 Stück  
50 Stück



**Messing-Zierhaken**  
Hakenhöhe ca. 70 mm  
Wandabstand ca. 30 mm

482013  
482323

messing-glanz  
weiß







  
50 Stück  
50 Stück





## Messing-Rosettenhaken mit Stockschraube







Rosettendurchmesser ca. 40 mm  
Wandabstand ca. 41 mm

710247	messing-glanz		25 Stück
760247	messing-matt		25 Stück
770247	nickel-matt		25 Stück
720247	verchromt		25 Stück

## Rosettenhaken mit Kugel mit Stockschraube

Rosettendurchmesser ca. 19 mm  
Wandabstand ca. 30 mm









710097	messing-glanz		50 Stück
710297	messing-matt		50 Stück
720197	nickel-matt		50 Stück
720097	verchromt		50 Stück
750097	bronziert		50 Stück
750957	weiß		50 Stück
730197	schwarz		50 Stück

## Rosettenhaken mit Kugel mit Stockschraube

Rosettendurchmesser ca. 25 mm  
Wandabstand ca. 39 mm



710087	messing-glanz		25 Stück
710287	messing-matt		25 Stück
720187	nickel-matt		25 Stück
720087	verchromt		25 Stück
750087	bronziert		25 Stück
750857	weiß		25 Stück
730187	schwarz		25 Stück

## Messing-Zier- und Deckenhaken mit Stockschraube

Hakenhöhe 29 mm  
Wandabstand 38 mm



482485	nickel-matt		25 Stück 
--------	-------------	-------------------------------------------------------------------------------------	------------------------------------------------------------------------------------------------

Art.-Nr. Artikel-Bezeichnung VE



## FLEXIBLE WELLE Gardinenband

Funktioniert ohne Gleiterkette oder Wellenhalter

- Zugabe frei anpassbar  
Falte 4 cm / Rapport 250,  
Falte 5 cm / Rapport 230,  
Falte 6 cm / Rapport 200,  
Falte 8 cm / Rapport 180
- Welle kann flexibel gestaltet werden
- Verwendbar mit vielen Gleitern, Rollen und Faltenleghaken

### Gardinenband FLEXIBLE WELLE

112537 75 mm breit transparent Rolle 50 m 

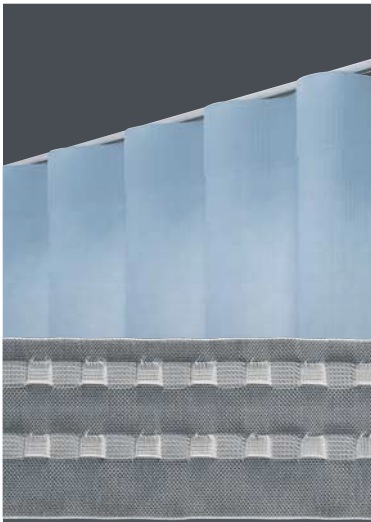

## PARSUNDA Wellenband + FLEXUS Wellenhalter

Gleichmäßige Falten für Gardinen bei Innenlaufschienen

- Der Rapport ist frei wählbar
- Bei 2:1 Zugabe: 4 Wellenhalter FLEXUS per Meter (Markierungen im Band)
- Der Wellenhalter FLEXUS bietet 6cm Abstand
- Verwendbar mit vielen Gleitern, Rollen und Faltenleghaken
- Wellenhalter in eine untere Schlaufe einschieben, in der darüber liegenden einen Haken Ihrer Wahl – fertig!

### Wellenband PARSUNDA

112536 75 mm breit transparent Rolle 50 m

### Wellenhalter FLEXUS

112379 Abstand 6 cm transparent 100 Stück 

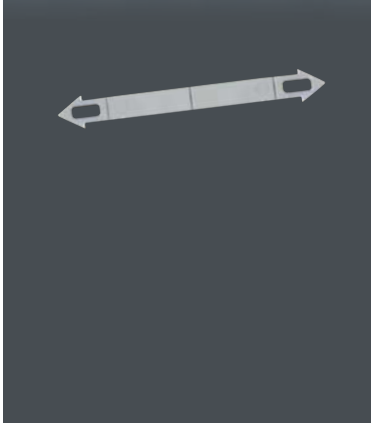

Eine kleine Auswahl unserer kombinierbaren Rollen und Haken, weitere finden Sie auf den Seiten D 340 bis D 343 und D 379.



104002	<b>Faltenlegrollen</b> , konische Rolle, Rollen-Ø 8 mm	100 Stück 
104804	<b>X-Gleiter</b> für Alu-Schienen mit Laufbreite 6 mm	100 Stück
107001	<b>Gleiter</b> mit Faltenleghaken, runder Kopf, für 4 mm	100 Stück
507508	<b>Faltenleghaken</b> weiß, Öse 6 mm Ø	100 Stück
507504	<b>Faltenleghaken</b> glasklar, Öse 7 mm Ø	100 Stück
507404	<b>Faltenleghaken</b> glasklar, Öse 10 mm Ø	100 Stück

Art.-Nr.

Artikel-Bezeichnung

VE

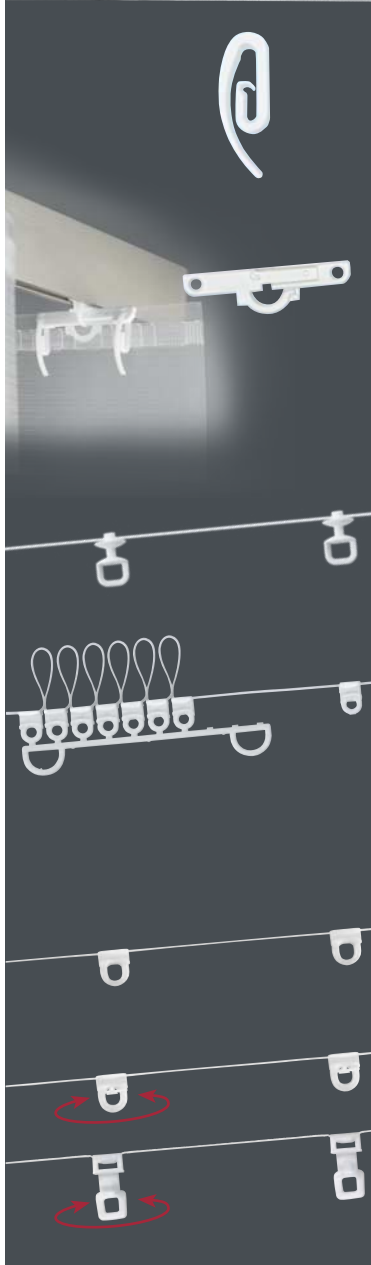
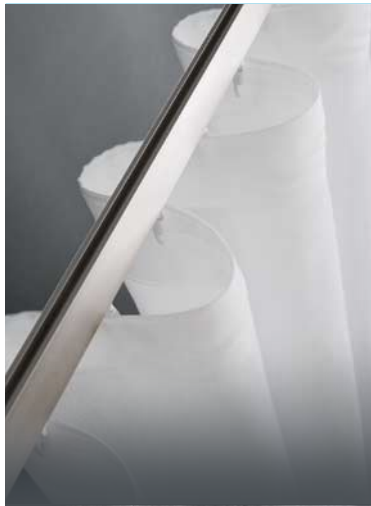

## LaOla

### Das Prinzip

Die LaOla-Kette besteht aus Kunststoff-Gleitern, die mit einer dünnen Perlorkordel in einem Abstand von 6 cm oder 8 cm fest verbunden sind. Zentriert in eine Innenlaufschiene eingezogen werden gleichförmige Wellen gebildet.

An die LaOla-Kette wird mittels Schlaufhaken die mit dem LaOla-Wellenband versehene Dekoration befestigt.

Das LaOla-Wellenband ist 75 mm breit und besteht aus endlos aneinander gereihten Schlaufen.

### Der Vorteil

Beim Öffnen oder Zuziehen des Stoffes fallen die Wellen absolut gleichmäßig. Für eine elegante Wellendekoration gilt ein Stoffverbrauch von 1:2. Hierfür nutzen Sie die gekennzeichnete 7. Schlaufe.

### LaOla-Kette 112 370

geeignet für Läufe mit folgenden Maßen:

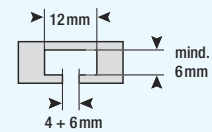

### LaOla-Kette 112 375

geeignet für Läufe mit folgenden Maßen:

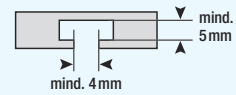

### Alle weiteren LaOla-Ketten

geeignet für Läufe mit folgenden Maßen:

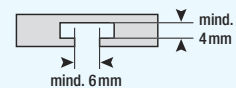

## LaOla Wellenfaltenband

Schlaufe an Schlaufe, transparent

112371  
112383

75 mm breit  
120 mm breit

Rolle 100 m  
Rolle 100 m

## LaOla Schlaufhaken

112373  
112367  
112389

weiß  
silber  
schwarz



100 St.  
100 St.  
100 St.

## LaOla Seitenhalter 90°

zur Ausrichtung der ersten und letzten Falte, mit Öse für Schleuderstab

112377  
112368  
112385

weiß  
silber  
schwarz



20 St.  
20 St.  
20 St.

## LaOla Kette, Kordel mit Gleitern

112370  
112375

für 4 + 6 mm-Läufe ab 6 mm Höhe, Abstand 80 mm  
weiß

Rolle 50 m

für 4 mm-Läufe ab 5 mm Höhe, Abstand 80 mm  
weiß

Strang 50 m

112374  
112369  
112384

für 6 mm-Läufe ab 4 mm Höhe, Abstand 80 mm  
weiß  
silber  
schwarz



Strang 50 m  
Strang 50 m  
Strang 50 m

112376

für 6 mm-Läufe ab 4 mm Höhe, Abstand 60 mm  
weiß

Strang 50 m

## LaOla Kette Teflon beschichtet

112386

für 6 mm-Läufe ab 4 mm Höhe, Abstand 80 mm  
weiß

Rolle 50 m

112387

drehbar  
für 6 mm-Läufe ab 4 mm Höhe, Abstand 80 mm  
weiß

Rolle 25 m

112388

**LaOla Klick-Gleiter Kette** Teflon beschichtet  
drehbar  
für 6 mm-Läufe ab 4 mm Höhe, Abstand 80 mm  
weiß

Rolle 25 m

Art.-Nr.

Artikel-Bezeichnung

VE

## MODIE Wellenband

- Die Gardine fällt in schöne gleichmäßige Wellen
- Für viele gängige Schienen und Stangen mit 6 mm Innenlauf
- Die Kette besteht aus Kunststoff-Gleitern, die mit einer Kordel fest verbunden sind
- Beim Öffnen und Zuziehen des Stoffes fallen die Wellen absolut gleichmäßig

## MODIE Wellenfaltenband

77 mm breit

Mo377-000 transparent

Rolle 50 m

Mo277-570 schwarz

Rolle 50 m

## MODIE Gardinenhaken

30 mm hoch

Mo304-128 weiß

1.000 Stück

Mo304-570 schwarz

1.000 Stück

## MODIE Seitenhalter 90°

zur Ausrichtung der ersten und letzten Falte, mit Öse für Schleuderstab

Mo565-128 weiß

Breite änderbar von 70 bis 150 mm

10 Stück

50 Stück

Mo565-570 schwarz

Breite änderbar von 70 bis 150 mm

10 Stück

50 Stück

Mo566-000 transparent

fixe Breite 77 mm

10 Stück

50 Stück

## MODIE Gleiterkette

Kordel mit Gleitern für 6 mm-Läufe, 1.000 Gleiter mit einem von Abstand 80 mm

Mo606-128 weiß

Rolle 80 m

Mo608-570 schwarz

Rolle 80 m

Die MODIE Gleiterketten passen u. a. in die Profile EDIX 16 mm, 20 mm und 28 mm, VION 20 mm, ED MAXI, RUND, HIGH, WENDESCHIENE und FLOW sowie FineLine 35/14. Für eloxierte Profile empfehlen wir unser PTFE Gleitspray 123121.

## Musterset MODIE Wellenband

Gleiterkette 1,5 m, Faltenband 1,5 m, Gardinenhaken 12 St., Seitenhalter 1 farbig und 1 transparent

Mo606-MUSTER weiß

Mo608-MUSTER schwarz

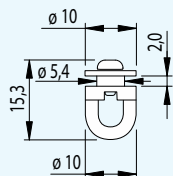



Art.-Nr. Artikel-Bezeichnung VE



## Gleiterkette für Wellenbänder

Gleiter und Kette zum Zusammenstecken

**112540 Eindrengleiter** mit Öse für Schlaufhaken für 6 mm Läufe (ohne Kette) 110 St.

**Kette** für Eindrengleiter für 6 mm Läufe, ab 5 mm Laufkanal-Höhe

**112541** Abstand 80 mm Rolle 100 m  
**112542** Abstand 60 mm Rolle 100 m



## Steg-Faltenband

Variable Falten für Vorhänge und Gardinen bei Vorhangstangen

**Steg-Faltenband** »variabel« Polyester, transparent

**112347** 50 mm breit, 120 mm Rapport (1 Schlaufenbreite) Rolle 100 m  
**112346** 100 mm breit, 210 mm Rapport (2 Schlaufenbreiten) Rolle 100 m

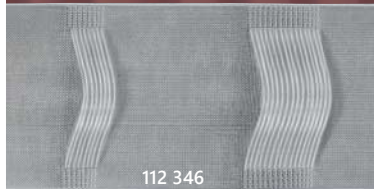

**Steg-Faltenband** »Fäden« Polyester, transparent

**112357** 50 mm breit, Stegabstand: 150 mm Rolle 100 m  
**112356** 100 mm breit, Stegabstand: 150 mm Rolle 100 m

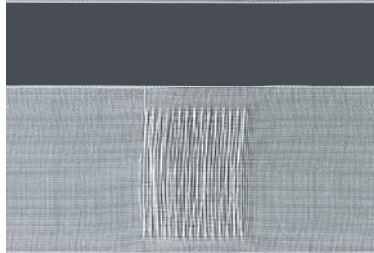

**Steg-Faltenband** »geschweißt« Polyester, transparent

**112355** 100 mm breit, Stegabstand: 150 mm Rolle 50 m



## WELLEN-Passring

Die perfekte Welle für Deko-Ösen

- Passringe und Kugelkette sind komplett hinter dem Vorhang verborgen
- Mit der Kugelkette ist die Wellentiefe frei wählbar
- Der Passring wirkt zugleich wie ein Verstärkungsring

**317356 Passring** transparent, Ø Innen x Außen: 43 x 62 mm, 100 St.  
für 40 mm Ø Ösen 500 St.  
1.000 St.

**126072 Kugelkette** transparent, Kugelabstand: 6 mm 1 m  
150 m

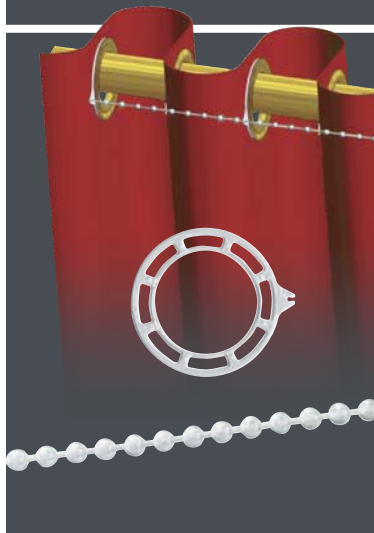

Unsere 40er Deko-Ösen finden Sie auf den Seiten D 426 + D 427.



Art.-Nr.	Artikel-Bezeichnung	VE																															
<b>Universal-Gardinenband, Polyester</b>																																	
112000	24 mm breit, weiß	Karte 50 m																															
112001	24 mm breit, weiß	Rolle 200 m																															
112051	22 mm breit, weiß, Standard	Rolle 200 m																															
112002-	22 mm breit, farbig	Karte 50 m																															
	<table border="0"> <tr> <td></td> <td>1 ecru</td> <td></td> <td>12 dunkelbeige</td> <td></td> <td>10 marine</td> </tr> <tr> <td></td> <td>6 gelb</td> <td></td> <td>5 grau</td> <td></td> <td>13 dunkelblau</td> </tr> <tr> <td></td> <td>2 hellbeige</td> <td></td> <td>7 weißgrün</td> <td></td> <td>4 schwarz</td> </tr> <tr> <td></td> <td>11 lachs</td> <td></td> <td>8 gelbgrün</td> <td></td> <td></td> </tr> <tr> <td></td> <td>3 dunkelrot</td> <td></td> <td>9 blau</td> <td></td> <td></td> </tr> </table>		1 ecru		12 dunkelbeige		10 marine		6 gelb		5 grau		13 dunkelblau		2 hellbeige		7 weißgrün		4 schwarz		11 lachs		8 gelbgrün				3 dunkelrot		9 blau				
	1 ecru		12 dunkelbeige		10 marine																												
	6 gelb		5 grau		13 dunkelblau																												
	2 hellbeige		7 weißgrün		4 schwarz																												
	11 lachs		8 gelbgrün																														
	3 dunkelrot		9 blau																														
091127	<b>Musterkarte</b> Gardinenband, farbig	1 Stück																															
112059	50 mm breit, mit 2 Taschenreihen	weiß	Rolle 100 m																														
112059-1	50 mm breit, mit 2 Taschenreihen	transparent	Rolle 100 m																														
<b>Universal-Gardinenband, Polyester</b>																																	
112009	22 mm breit, transparent, Zweier-Schlaufen, Wiederholung mit Unterbrechung	Rolle 200 m																															
112049	23 mm breit, transparent, fortlaufende gleichbleibende Schlaufen, ohne Unterbrechung	Rolle 250 m																															
<b>Schwerstegband, Polyester</b>																																	
	30 mm breit, für Bühnenvorhänge																																
112255	weiß		Rolle 100 m																														
112255-1	schwarz		Rolle 100 m																														
<b>Universal-Gardinenband, Polyester</b>																																	
112139	50 mm breit, transparent, 2 Zugfäden	Rolle 100 m																															
<b>Automatik-Faltenband, Polyester</b>																																	
	26 mm breit, weiß																																
112015	4-er Falte 3,0 : 1	Rapport 240 mm Faltenabst. 80 mm	Rolle 200 m																														
112016	4-er Falte 2,7 : 1	Rapport 216 mm Faltenabst. 80 mm	Rolle 200 m																														
112017	3-er Falte 2,5 : 1	Rapport 200 mm Faltenabst. 80 mm	Rolle 200 m																														
112102	3-er Falte 2,0 : 1	Rapport 200 mm Faltenabst. 100 mm	Rolle 200 m																														
<b>Automatik-Faltenband »Traumfalte«, Polyester</b>																																	
	26 mm breit, weiß																																
112105	4-er Falte 3 : 1	Rapport 180 mm Faltenabst. 60 mm	Rolle 200 m																														



Art.-Nr.	Artikel-Bezeichnung	VE		
	<b>Automatik-Faltenband</b> , Polyester 29 mm breit, weiß Bitte ca. 5 mm unterhalb der oberen Zugschnur annähen.			
112316	Flachfalte 2,0 : 1	Rapport 160 mm	Faltenabst. 80 mm	Rolle 100 m
	<b>Automatik-Faltenband / Flachfalte</b> , Polyester 50 mm breit, transparent 2 Taschenreihen, 2 Zugschnüre			
112322	Flachfalte 1 : 2,5	Rapport 215 mm	Faltenabst. 75 mm	Rolle 100 m
112323	Flachfalte 1 : 3,0	Rapport 220 mm	Faltenabst. 70 mm	Rolle 100 m
	<b>Faltenband</b> , Polyester 50 mm breit, weiß			
112035	4-er Falte 3,0 : 1	Rapport 265 mm	Faltenabst. 82 mm	Rolle 100 m
112037	3-er Falte 2,5 : 1	Rapport 220 mm	Faltenabst. 88 mm	Rolle 100 m
112038	3-er Falte 2,2 : 1	Rapport 180 mm	Faltenabst. 83 mm	Rolle 100 m
112039	3-er Falte 2,0 : 1	Rapport 205 mm	Faltenabst. 102 mm	Rolle 100 m
	<b>Faltenband</b> , Polyester 50 mm breit, transparent			
112030	4-er Falte 3,0 : 1	Rapport 240 mm	Faltenabst. 80 mm	Rolle 100 m
112031	3-er Falte 2,5 : 1	Rapport 240 mm	Faltenabst. 96 mm	Rolle 100 m
112032	3-er Falte 2,2 : 1	Rapport 240 mm	Faltenabst. 109 mm	Rolle 100 m
112133	3-er Falte 2,0 : 1	Rapport 240 mm	Faltenabst. 120 mm	Rolle 100 m
	<b>Automatik-Faltenband</b> , Polyester 29 mm breit, weiß mit Querfäden für Scheibengardinen			
112055	3-er Falte 2,5 : 1	Rapport 150 mm	Faltenabst. 50 mm	Rolle 250 m
	<b>Durchschubband</b> , Polyester transparent für Beschwerungsprofile			
112056	44 mm breit			Rolle 100 m
	<b>Faltenclip</b> Mit dem Durchschubband (112 056) die ideale Kombination für den Einsatz bei Faltrollos.			
115034	transparent			100 Stück





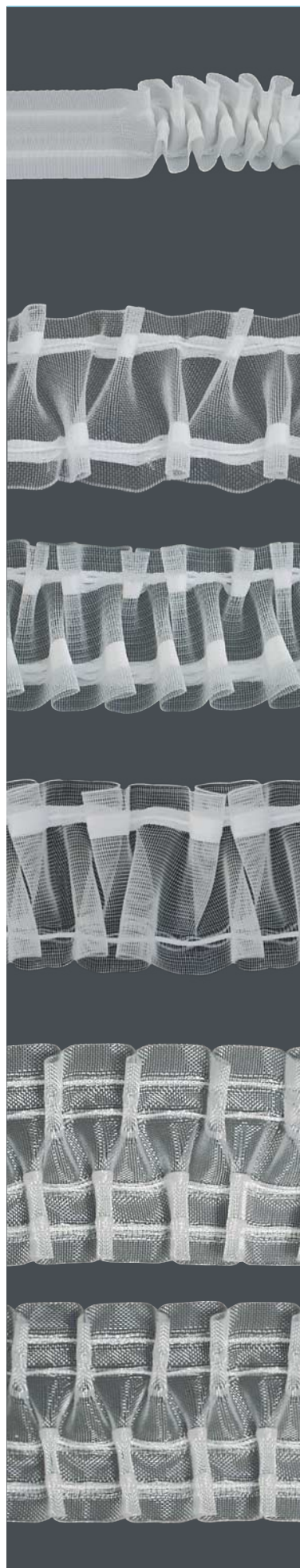

Art.-Nr.	Artikel-Bezeichnung	VE
112215	<b>Faltenband »Mini Smok«</b> , Polyester 29 mm breit, rohweiß variabel	Rolle 200 m
112320	<b>Faltenband »Smok«</b> , Polyester 50 mm breit, transparent, auch für Raffhalter geeignet Rapport 2,0 : 1      60 mm	Rolle 100 m
112319	2,5 : 1      60 mm	Rolle 100 m
112300	3,0 : 1      45 mm	Rolle 100 m
112225	<b>Faltenband »Smok«</b> , Polyester 50 mm breit, transparent, variable Ausführung, für alle Stoffverbräuche geeignet variabel	Rolle 100 m
112202	<b>Faltenband »Smok«</b> , Polyester 60 mm breit, transparent Rapport 2,5 : 1      52 mm	Rolle 100 m
112205	<b>Faltenband »Smok«</b> , Polyester 70 mm breit, volltransparent variabel	Rolle 100 m
112203	<b>Faltenband »Smok«</b> , Polyester 70 mm breit, volltransparent Rapport 2,0 : 1      54 mm	Rolle 100 m
112204	2,5 : 1      57 mm	Rolle 100 m

Art.-Nr. Artikel-Bezeichnung VE

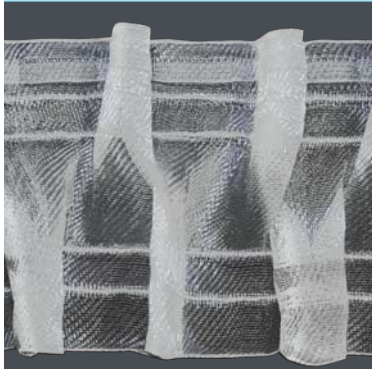

**Faltenband »Smok«**, Polyester  
Mit Querschlaufen für Stangendurchschub und Zugfäden zur Faltenbildung.  
100 mm breit, volltransparent

Art.-Nr.	Verhältnis	Rapport	Faltenabst.	Querschlaufen Abstand	VE
112532	2,0 : 1	80 mm		160 mm	Rolle 100 m
112533	2,5 : 1	80 mm		200 mm	Rolle 100 m



**Faltenband »Bleistift-Falte«**, Polyester  
35 mm breit, weiß,  
2 Taschenreihen

Art.-Nr.	Verhältnis	Rapport	Faltenabst.	VE
112331	2,0 : 1	27 mm	14 mm	Rolle 200 m
112333	2,5 : 1	28 mm	12 mm	Rolle 200 m

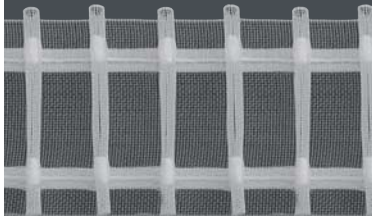

**Faltenband »Bleistift-Falte«**, Polyester  
50 mm breit, transparent

Art.-Nr.	Verhältnis	Rapport	Faltenabst.	VE
112227	2,5 : 1	39 mm	15 mm	Rolle 100 m
112228	2,0 : 1	44 mm	21 mm	Rolle 100 m

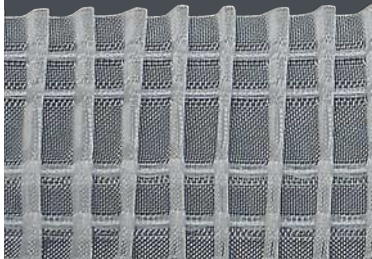

**Faltenband »Bleistift-Falte«**, Polyester  
70 mm breit, volltransparent

Art.-Nr.	Verhältnis	Rapport	Faltenabst.	VE
112426	3,0 : 1	45 mm	15 mm	Rolle 100 m
112427	2,5 : 1	38 mm	15 mm	Rolle 100 m
112428	2,0 : 1	32 mm	16 mm	Rolle 100 m

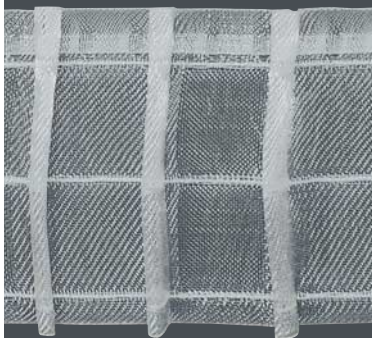

**Faltenband »Bleistift-Falte«**, Polyester  
Mit Querschlaufen für Stangendurchschub und Zugfäden zur Faltenbildung.  
100 mm breit, volltransparent

Art.-Nr.	Verhältnis	Rapport	Faltenabst.	Querschlaufen Abstand	VE
112531	2 : 1	80 mm	40 mm	160 mm	Rolle 100 m

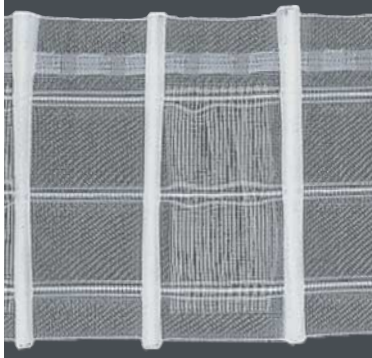

**Faltenband »Bleistift-Falte«**, Polyester  
Mit Querschlaufen für Stangendurchschub und Zugfäden zur Faltenbildung.  
100 mm breit, volltransparent

Art.-Nr.	Verhältnis	Rapport	Faltenabst.	Querschlaufen Abstand	VE
112538	2 : 1	70 mm	35 mm	150 mm	Rolle 100 m



Art.-Nr. Artikel-Bezeichnung VE

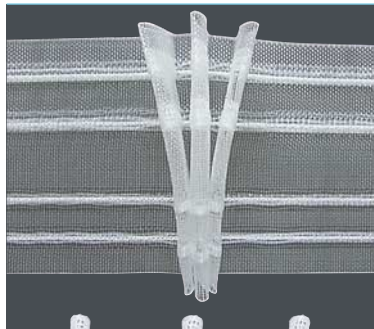

<b>Faltenband »V-Falte«, Polyester</b> 70 mm breit, volltransparent		Rapport	Faltenabst.	
112490	3,0 : 1	215 mm	80 mm	Rolle 100 m
112491	2,5 : 1	205 mm	100 mm	Rolle 100 m
112492	2,0 : 1	230 mm	120 mm	Rolle 100 m



<b>Flausch-Faltenband »Stabfalte«, 78% PES / 22% PA</b> 50 mm breit, weiß			
112412	2,5:1	Rolle	50 m
112416	2,0:1	Rolle	50 m



<b>Gardinenband Musterkarte</b>		
091142	Übersicht der wichtigsten Schmuckfaltenbänder	1 Stück

## Metallhaken

- Die speziellen Metallhaken ermöglichen eine variable Stoffzugabe
- Haken mit Überstand können die Gardinenstange verdecken
- Die Haken können in beliebige Ösenhaken und Gleitringe eingehängt werden



<b>Gardinenband für Metallhaken</b>		
112535	90 mm breit, weiß	Rolle 100 m

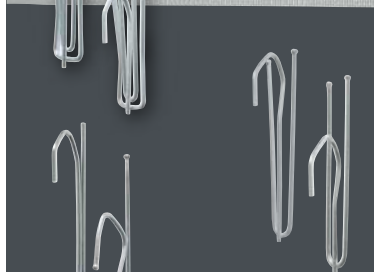

<b>4 Finger - Metallhaken 2 mm Ø</b>		
608151	ohne Überstand	10 Stück
608152	mit ca. 30 mm Überstand	10 Stück

<b>2 Finger - Metallhaken 2 mm Ø</b>		
608153	ohne Überstand	10 Stück
608154	mit ca. 25 mm Überstand	10 Stück

<b>1 Finger - Metallhaken 2 mm Ø</b>		
608155	ohne Überstand	10 Stück
608156	mit ca. 25 mm Überstand	10 Stück



<b>Einstellbarer Gardinenhaken</b>		
Kunststoff, zum Einstecken, Überstand anpassbar		
608157	75 mm hoch	200 Stück
608158	85 mm hoch	200 Stück



<b>Ösenhaken</b>		
722-4-00	für Flachringe, transparent, aus unserer Kollektion VION (Einzelteile).	100 Stück

<b>Gleitring mit Öse</b>		
125920-08	mit Kunststoffeinlage, Innen-Ø 27 mm, alu matt, weitere Gleitringe in unserer Kollektion VION (Einzelteile).	50 Stück

Art.-Nr.

Artikel-Bezeichnung

VE

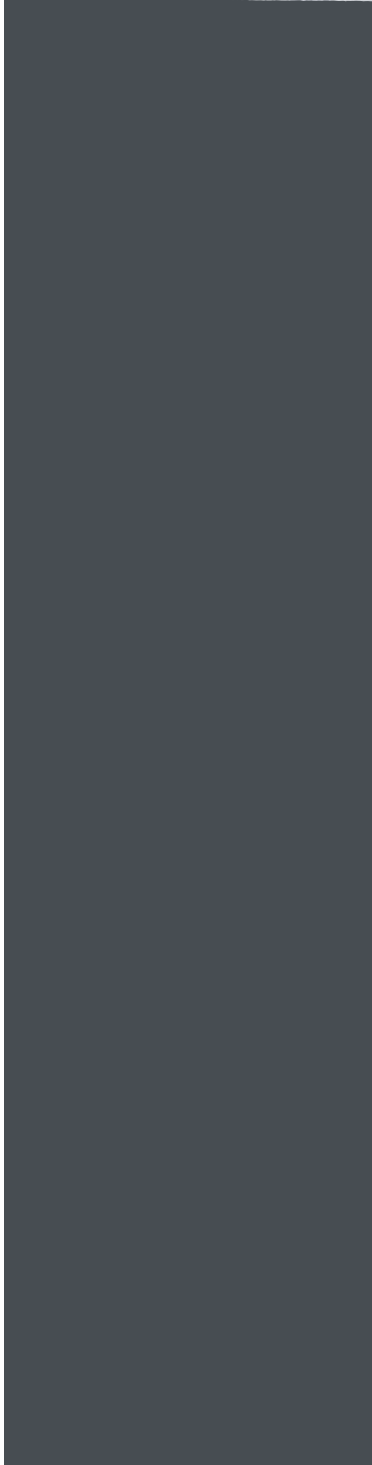

## Multi-Taschenband

Viele Anwendungsmöglichkeiten

- Bleistiffalte durch Ziehen der 2 Zugschnüre
- Verwendung mit Faltenleghaken
- Verwendung mit Metall- oder Kunststoffhaken
- Nutzung als Stegband



85 mm breit, weiß,  
3 Taschenreihen, 2 Zugschnüre

112358

1 : 2,0

Rapport  
40 mm

Stegabstand  
160 mm

 Rolle 100 m

- Faltenabstand 20 mm
- Querschlaufen 65 mm x 22 mm
- Taschenreihen 9 mm lang, oben und unten 5 mm breit, mittlere 18 mm breit

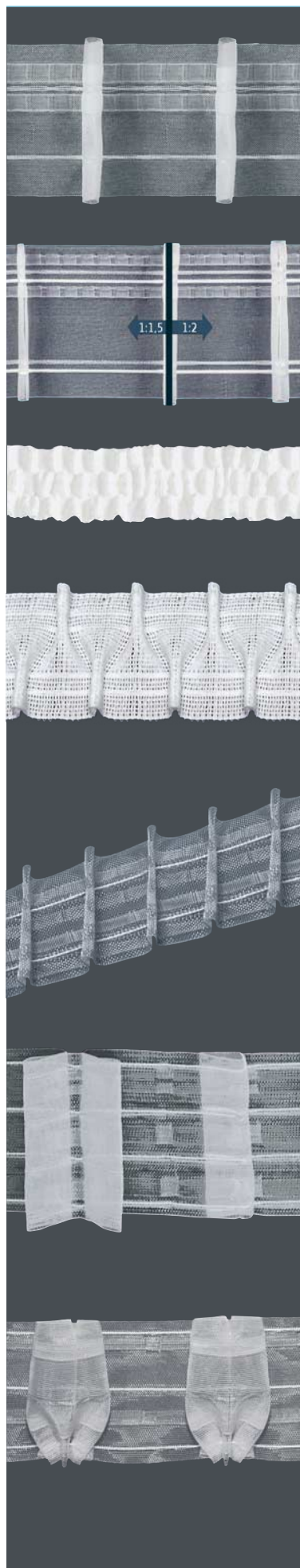

Art.-Nr. Artikel-Bezeichnung VE

**Faltenband »1er Falte«**, Polyester  
100 mm breit, transparent,  
2 Taschenreihen, 2 Zugschnüre

112353 1 : 2 Rapport 170 mm Faltenabst. 85 mm Rolle 100 m

**Faltenband »1er Falte«**, Polyester  
100 mm breit, transparent, 2 Taschenreihen,  
»Zweifachzugabe« – je 2 Zugschnüre weiß und transparent

112354 1 : 1,5 oder 1 : 2,0 Rolle 100 m

Zugschnur Rapport Faltenabst.  
1 : 1,5 transparent 165 mm 110 mm  
1 : 2,0 weiß 165 mm 83 mm

**Flausch-Kräuselband**, Polyester  
weiß, mit Flauchrücken

112253 24 mm breit Rolle 50 m  
200 m

**Flausch-Faltenband »Smok«**, 74% PES / 26% PA  
50 mm breit, weiß,  
mit Flauchrücken

112534 2,5 : 1 Rapport 60 mm Faltenabst. variabel Rolle 50 m

**Automatik-Faltenband-Spezial**, Polyester  
50 mm breit, transparent,  
für schräge Dachfenster, Faltenbildung im 45° Winkel

112351 2 : 1 rechtsschräg Rolle 100 m  
112352 2 : 1 linksschräg Rolle 100 m

Für gerade Fensterteile bitte die Art. 112 331 oder 112 333 (Seite D 405) verwenden.

**Kreativband »Zweifachzugabe«**  
Zwei Stoffverhältnisse in einem Band:  
Zugschnüre transparent = Falte 2,0 : 1  
Zugschnüre weiß = Falte 2,5 : 1

Automatik-Faltenband, Faltenanzahl 2, 100 mm breit,  
Polyester transparent

112380 2,0 : 1 oder 2,5 : 1 Rolle 50 m

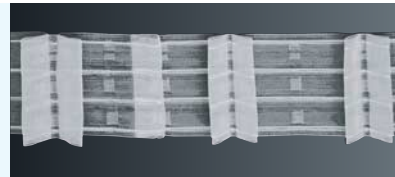

**Pokalfalte**, Polyester  
90 mm breit, transparent,  
2 Taschenreihen, 3 Zugschnüre

112530 1 : 2,5 Rapport 245 mm Rolle 100 m

# Bügeleinlagen | Näheinlagen

Art.-Nr.	Artikel-Bezeichnung	VE
113088 113090	<b>Schabracken-Bügeleinlage, Antiknick</b> aufbügelbar, doppelseitig beschichtet Farbe: rohweiß, inkl. Silikonpapier	25 m
		40 cm breit 25 m
113092 113093	<b>Silikonpapier</b> , bei Anschnitt bitte separat bestellen	3 m 3 m
113015 113020 AV	<b>Schabracken-Bügeleinlage Vlieseline</b> fixierbar, weiß	25 m 30 m
113087 113089 113085	<b>Gewebeeinlage Vlieseline</b> fixierbar	25 m 25 m 25 m
113022 113022-1	<b>Volumen-Vlies Vlieseline</b> fixierbar, weiß, für weiche textile Schabracken und Raffhalter, wasch- und reinigungsbeständig bis 40° C	30 m 30 m
113024	<b>Vlieseline-Saumfix</b> anbügelbar Ideal für Nahteinschläge und zur festen Verbindung von Bordüren und Säumen	1 Rolle
113030 113031 113032 AV 113033 AV	<b>Vliesofix</b> aufbügelbares Klebeweb, weiß	1 Rolle 1 Rolle 1 Rolle 1 Rolle
113039	<b>Formband</b> zur Sicherung von schräg oder rund zugeschnittenen Kanten, weiß	1 Rolle
113044 113045	<b>Kantenband</b> bügelbar, stabilisiert Kanten, z.B. für Flächenvorhänge, 2 cm breit	1 Rolle 1 Rolle
113052 AV	<b>Näheinlage, Vlieseline ILC151</b> weiß, waschbar bis 60° C	51 g/m <sup>2</sup> 100% PES    93 cm breit 1 m 10 m

# Bügeleinlagen



Art.-Nr.	Artikel-Bezeichnung	VE
	<b>Einlage für Raffhalter und Schleifen, Vlieseline</b> fixierbar, Bügeleinlage für alle Stoffe geeignet, wasch- und reinigungsbeständig bis 40° C, weiß	
113023	H 310 90 cm breit	25 m
	<b>Bügeleinlage »Standard«</b> , weiß	
113069	H 200, leichte Einlage 90 cm breit	25 m
113068	H 250, stabile Einlage 90 cm breit	25 m
091144	<b>Musterbuch für Vlieseline</b>	1 Stück



	<b>Aufbügelbares Vlies</b> Leichte Einlagen mit etwas Stabilität für Kleinteile wie Schleifen, Raffhalter und Blenden, zum Abfüttern geeignet, für leichte Stoffe. 100 % Polyester, einseitig beschichtet, waschbar bei 40° C und mehr: Schmelzpunkt des Klebers: 135° C (28 g/m <sup>2</sup> ), 100° C (ab 40 g/m <sup>2</sup> )	
113091	28 g/m <sup>2</sup> , weiß	90 cm breit Rolle à 100 m
113094	28 g/m <sup>2</sup> , schwarz	90 cm breit Rolle à 100 m
113098	40 g/m <sup>2</sup> , weiß	90 cm breit Rolle à 30 m
113099	40 g/m <sup>2</sup> , schwarz	90 cm breit Rolle à 30 m
113100	100 g/m <sup>2</sup> , weiß	90 cm breit Rolle à 30 m



	<b>Super-Raffhalter-Bügeleinlage</b> , fest vorgestanz, aufbügelbar, chemisch reinigungsbeständig, knickfeste Gewebe/Vlies-Kombination	
113025	60 cm Spannweite	50 Stück
113026	70 cm Spannweite	50 Stück
113027	80 cm Spannweite	50 Stück
113028	90 cm Spannweite	50 Stück



	<b>Watte-Keder, Flauch-Schnur</b> Polyester, Farbe: weiß – waschbeständig bis 30° C	
113035	10 mm Ø	25 m
113036	18 mm Ø	25 m
113037	30 mm Ø	15 m



	<b>Vlies-Kederschnur</b> Farbe: weiß – waschbeständig bis 30° C	
230521	4 mm Ø, glatt + weich	500 m
230522	5 mm Ø, glatt + weich	350 m

	<b>Deko-Watteschnur</b> Farbe: rohweiß – chemisch reinigungsbeständig	
230523	Ø 3 mm Rolle à 100 m	1 Rolle
230524	Ø 4 mm Rolle à 100 m	1 Rolle
230525	Ø 5 mm Rolle à 50 m	1 Rolle
230526	Ø 6 mm Rolle à 50 m	1 Rolle
230528	Ø 8 mm Rolle à 25 m	1 Rolle

Mengenrabatt Deko-Watteschnur ab 8 Rollen: 20%

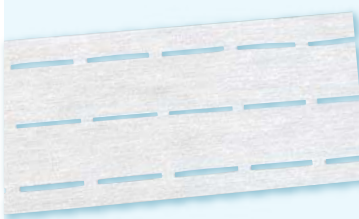

	<b>Perforiertes Falz-Fixierband</b> mit Bügelbeschichtung, speziell zur Herstellung von Dekoschlaufen, Farbe: weiß	
	<b>Endbreite / offene Breite</b>	
113063	2,5 cm 7,0 cm	Rolle à 50 m
113062	3,0 cm 8,0 cm	Rolle à 50 m

Art.-Nr. Artikel-Bezeichnung VE

## Klick-Schlaufengleiter für Innenlaufschienen



115039	Klick-Schlaufenhalter für 50 mm Schlaufen	100 Stück
115039-1	Klick-Gleiter für 6 mm	100 Stück
115039-2	Klick-Gleiter für 4 mm	100 Stück



Klick-Schlaufenhalter und Gleiter

## Schlaufengleiter für Innenlaufschienen



115018	für 40 mm Schlaufen	100 Stück
615018	für 40 mm Schlaufen, SB-verpackt à 7 Stück	20 Blister



115038	für 50 mm Schlaufen	100 Stück
615038	für 50 mm Schlaufen, SB-verpackt à 7 Stück	20 Blister







## Beschwerungsband

Seite D 413



## Faltensteckpistole und Nadeln

ab Seite D 414



## Nähgarn

ab Seite D 416



## Reißverschlüsse

Seite D 418

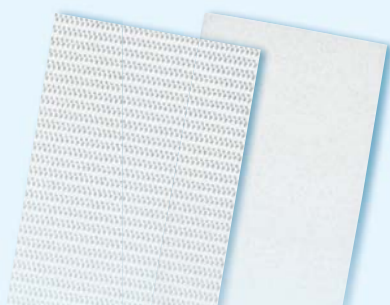

## Klettverschlüsse

Seite D 420

Art.-Nr. Artikel-Bezeichnung VE



## Tischdeckenunterlage

weiß, mit Prägung, rutschfest, problemlos zu schneiden

### Kompakt

PES/Glasgarn

Gewebe beidseitig beschichtet mit spezieller PVC-Paste, waschbar bis 60° C

113125 AV	100 cm breit	1 m
113126	140 cm breit	30 m

### Ideal

PES/ Glasgarn

Gewebe beidseitig beschichtet mit PVC, sehr strapazierfähig, feucht abwischbar, waschbar bis 60° C

113111	110 cm breit	20 m
113112	135 cm breit	20 m
113113	170 cm breit	20 m

### Komfort

Oberseite PVC-Schaumbeschichtung, Unterseite Polyester-Vlies, feucht abwischbar, waschbar bis 30° C

113123	110 cm breit	20 m
113124	140 cm breit	20 m



## Nahtband / Körperband



113042-100	20 mm breit	reinweiß		BW, waschbar bis 60° C	100 m
113042-999	20 mm breit	schwarz		BW, waschbar bis 60° C	100 m
113059-100 AV	25 mm breit	reinweiß		Polyethylen	100 m
113059-706 AV	25 mm breit	rohweiß		Polyethylen	100 m
113059-999*	20 mm breit	schwarz		Polypropylen, besonders robust und strapazierfähig	50 m

## Schrägband

farbig

### Baumwolle

matt

113040-	gefalzt 40/20 mm	in 80 Farben erhältlich	Rolle à 20 m
113070-	gefalzt 60/30 mm	in 6 Farben erhältlich: weiß, creme, braun, grau, dunkelgrau, schwarz	Rolle à 20 m

### Duchesse

glänzend

113050-	gefalzt 40/20 mm	in 36 Farben erhältlich	Rolle à 20 m
---------	------------------	-------------------------	--------------

## Schrägband-Farbkarte

mit Farbnummern

091125	Baumwolle, matt, 80 Farben	1 Stück
091125-1	Duchesse, glänzend, 36 Farben	1 Stück

Farbkarte online: [www.ed-altena.de/Schraegband-Farbkarte](http://www.ed-altena.de/Schraegband-Farbkarte)

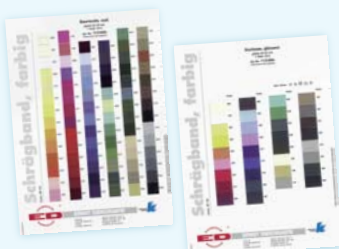

Großpackungen  
– wirtl. gelegt –  
auf Anfrage.

Art.-Nr. Artikel-Bezeichnung VE

## Beschwerungsband, Diolen, Blei Kugelform

109001	35 g	weiß		Rolle à 50 m	100 m
109002	50 g	weiß		Rolle à 50 m	100 m
109003	70 g	weiß		Rolle à 50 m	100 m
109004	85 g	weiß		Rolle à 50 m	100 m
109005	100 g	weiß		Rolle à 50 m	100 m
109006	150 g	weiß		Rolle à 25 m	100 m
109007	200 g	weiß		Rolle à 25 m	100 m



## Edelstahlband, Kugelform

EU konform\*

109002-1	50 g	weiß		Rolle à 50 m	100 m
----------	------	------	--	--------------	-------

Weitere Gewichte auf Anfrage.

## Beschwerungsband, Diolen, Walzenform

Blei pulverbeschichtet, EU konform\*

109100	25 g	weiß		Rolle à 50 m	100 m
109101	35 g	weiß		Rolle à 50 m	100 m
109102	50 g	weiß		Rolle à 50 m	100 m
109103	70 g	weiß		Rolle à 50 m	100 m
109104	85 g	weiß		Rolle à 50 m	100 m
109105	100 g	weiß		Rolle à 50 m	100 m
109106	150 g	weiß		Rolle à 25 m	100 m
109107	200 g	weiß		Rolle à 25 m	100 m

109108	35 g	silbergrau		Rolle à 50 m	100 m
109109	50 g	silbergrau		Rolle à 50 m	100 m
109110	70 g	silbergrau		Rolle à 50 m	100 m

109115	35 g	anthrazit		Rolle à 50 m	100 m
109116	50 g	anthrazit		Rolle à 50 m	100 m
109112	70 g	anthrazit		Rolle à 50 m	100 m

## Bleistäbchen, weiß lackiert, EU-konform\*

109014	13 g, ca. 38 mm lang		100 Stück
109015	25 g, ca. 58 mm lang		50 Stück
109016	50 g, ca. 78 mm lang		50 Stück
109018	13 g, ca. 38 mm lang		grau lackiert 100 Stück

## Zinkstäbchen, umweltfreundliches Metall, weiß lackiert, EU-Konform\*

109014-2	13 g, ca. 38 mm lang		100 Stück
109015-2	25 g, ca. 59 mm lang		50 Stück

## Edelstahlstäbchen, in Vlies, rohweiß, annähbar

109014-3	12 g, ca. 95 x 25 mm		250 Stück
----------	----------------------	--	-----------

## Bleitaler, weiß lackiert, EU-konform\*

109020	13 g, 25 mm Ø		100 Stück
--------	---------------	--	-----------

## Bleiplättchen, in Tasche, weiß, annähbar

109022	13 g, ca. 43 x 30 mm		100 Stück
--------	----------------------	--	-----------

## Bleiquasten, weiß umspinnen

109030	50 g, mit Schlaufe		25 Stück
--------	--------------------	--	----------

## Bleistreifen, weiß lackiert

109025	190 g, 115 cm lang		10 Stück
--------	--------------------	--	----------

Art.-Nr. Artikel-Bezeichnung VE



## Faltensteckpistole Typ X

306013 für Gardinen und Dekos, rationelles Arbeiten, bedeutende Kostenersparnis. Wo keine Stecknadel hält, besonders bei Grobstores, können die Faltenfäden in den Bleibandabschluss eingeschossen werden.

306002 Ersatznadel für Art.-Nr. 306 013 5 Stück

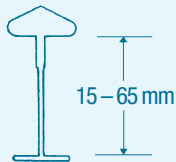
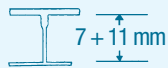

## Faltenfäden, Microspace

transparent,  
für Faltensteckpistole Banok Typ X

306008 7 mm extrafein 10.000 Stück  
306006 11 mm extrafein 10.000 Stück

306015 15 mm 5.000 Stück  
306020 20 mm 5.000 Stück  
306025 25 mm 5.000 Stück  
306035 35 mm 5.000 Stück  
306050 50 mm 5.000 Stück  
306065 65 mm 5.000 Stück

## Faltensteckpistole »Dennison«



306011 blau, mit feiner Nadel (Scherenform) für Gardinen und Dekos 1 Stück

306012 Ersatznadel für Art.-Nr. 306 011 5 Stück



## Faltenfäden

transparent,  
für Dennison (blau)

306007 7 mm 10.000 Stück

## Auszeichnungs- und Verpackungs-Zubehör



324101 **Etikettiergerät Typ S** mit kurzer Nadel zum Anheften Ihrer Auszeichnungsanhänger, einfach und problemlos, keine Beschädigung der Ware. 1 Stück

324001 Ersatznadel für Art.-Nr. 324101 5 Stück

## Nylonfäden für Etikettiergeräte

324015 15 mm 5.000 Stück  
324025 25 mm 5.000 Stück  
324040 40 mm 5.000 Stück  
324050 50 mm 5.000 Stück  
324070 65 mm 5.000 Stück  
324125 125 mm 5.000 Stück



Stückwarenanhänger und weitere Etikettiergeräte finden Sie in unserem Werkzeugkatalog auf Seite W 118.

## Doppel-T-Endfäden für Etikettiergeräte

324010 10 mm 5.000 Stück  
324020 25 mm 5.000 Stück





Art.-Nr. Artikel-Bezeichnung VE

**Stahl-Stecknadel** extra fein für Nähatelier  
Karton à 500 g

115004	Nr. 6	silberfarbig	30 mm	1 Karton
115008	Nr. 8	silberfarbig	35 mm	1 Karton

**Glaskopfstecknadeln** – Farben: sortiert



309010	2/0, 48 mm lang, Dose à ca. 100 St.	10 Dosen
309011	2/0, 48 mm lang	1.000 Stück
309016	2/0, 30 mm lang	1.000 Stück

**Stahl-Stecknadel**  
Karton à 5.000 Stück



115005	fein und rostfrei	32 mm	1 Karton
--------	-------------------	-------	----------

**Messing-Stecknadel**  
Karton à 500 g

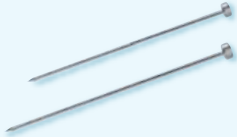

115002	105 Messing	silberfarbig	30 mm	1 Karton
115010	107 Messing	silberfarbig	34 mm	1 Karton

**Kunststoff-Stecknadel**, transparent



115030	ohne Widerhaken	Karton à 2.500 Stück	1 Karton
--------	-----------------	----------------------	----------

**Kunststoff-Stecknadel**, transparent



115035	mit Widerhaken	Karton à 2.000 Stück	1 Karton
--------	----------------	----------------------	----------

**Drapiernadel**



115032 <sup>AV</sup>	zum Anraffen und Befestigen von Stoffen, Nadel gedreht, Kopf transparent, 10 mm Ø	100 Stück
----------------------	--------------------------------------------------------------------------------------	-----------

**Faltenstecker**



115050	für Feinstores, glasklar	1.000 Stück
126026	glasklar, mit Schnurführungsring	100 Stück

**Faltenhalter**



115052	wasserklar	100 Stück
115055	weiß	100 Stück

**Faltenclip**

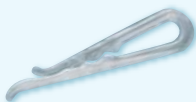

115056	für feine Gardinen, glasklar	1.000 Stück
--------	------------------------------	-------------



Art.-Nr.	Artikel-Bezeichnung	VE
<b>Transfil - Transparent - Nähgarn</b> 100 % Polyamid		
114001	40.000 m Spule 50/1	1 Spule
114002	45.000 m Spule 70/1	1 Spule
114004	Haube, transparent für Transfil	1 Stück
114003	200 m Spule 70/1	10 Spulen



<b>Nähgarn - sabaTex 120 Bauschgarn</b> 100 % Polyester, in 535 Farben erhältlich		
114050-	10.000 m Cone	5 Conen
114050XR-	RECYCLED 10.000 m Cone	5 Conen



<b>Nähgarn - Serafil 120/2 (180)</b> 100 % Polyester, in 78 Farben erhältlich		
214555-	5.000 m Fußspule	5 Spulen



<b>Nähgarn - Rasant 120</b> 60 % Polyester, 40 % Baumwolle, in 300 Farben erhältlich		
114005-	1.000 m Rolle	10 Rollen
114006-	5.000 m Cone	5 Conen



<b>Nähgarn-Sortiment Rasant 120</b> 48 Rollen à 1.000 m in 24 Farben		
114025	Klarsichtbox in aktuellen Dekofarben	1 Box
114026	Klarsichtbox in aktuellen Standardfarben	1 Box



<b>Nähgarn - Saba</b> 100 % Polyester, in 500 Farben erhältlich		
114011-	1.000 m Rolle <b>Saba 100</b>	10 Rollen
114012-	1.000 m Rolle <b>Saba 120</b>	10 Rollen



<b>Nähgarn-Sortiment Saba 120</b> 48 Rollen à 1.000 m in 24 Farben		
114029	Klarsichtbox in aktuellen Dekofarben	1 Box
114032	Klarsichtbox in aktuellen Standardfarben	1 Box



<b>Nähgarn - Seralon® No.100</b> 100 % Polyester, in 430 Farben erhältlich		
114010-	100 m Spule	10 Spulen
114013-	200 m Spule	5 Spulen



<b>Nähgarn-Sortiment Seralon® No.100</b> 100 % Polyester		
114008	240 Spulen à 100 m in 48 Farben Maße: H 323 mm, B 499 mm, T 216 mm	1 Sortiment
114024	480 Spulen à 100 m in 96 Farben Maße: H 502 mm, B 499 mm, T 216 mm	1 Sortiment

Weitere Nähgarnstärken und Ausführungen auf Anfrage,  
Nähgarn-Farbkarten stellen wir Ihnen gerne zur Verfügung!



Farbkarten finden Sie unter  
ed-altena.de/farbkarten

# Nähgarn für Polsterei und Sattlerei



Art.-Nr.	Artikel-Bezeichnung	VE
	<b>Serafil</b> – Nähgarn aus 100 % Polyester	
	<b>Serafil 10</b> in 148 Farben erhältlich	
214410-	300 m Fußspule	5 Spulen
	<b>Serafil 15</b> in 148 Farben erhältlich	
214419-	450 m Fußspule	5 Spulen
	<b>Serafil 20</b> in 240 Farben erhältlich	
214420-	600 m Fußspule	5 Spulen
214422-	<b>WR</b> – wasserabweisend 600 m Fußspule	1 Spule
	<b>Serafil 30</b> in 240 Farben erhältlich	
214430-	900 m Fußspule	5 Spulen
214432-	<b>WR</b> – wasserabweisend 900 m Fußspule	1 Spule
	<b>Serafil 40</b> in 240 Farben erhältlich	
214440-	1.200 m Fußspule	5 Spulen
214442-	<b>WR</b> – wasserabweisend 1.200 m Fußspule	1 Spule
	<b>Serafil 60</b> in 240 Farben erhältlich	
214450-	1.800 m Fußspule	5 Spulen
	<b>Serafil 80</b> in 240 Farben erhältlich	
214452-	2.400 m Fußspule	5 Spulen
	<b>Handnähfaden – Serafil 15 T90</b> Nachfolger von 11/2 S / Art.-Nr. 214 001 100 % Polyester, mittel gewachst	
214019-	1.000 m Rolle in 16 Farben erhältlich	6 Rollen
	<b>Rasant</b> – Nähgarn aus 80 % Polyester, 20 % Baumwolle	
	<b>Rasant Oxella 25</b> in 36 Farben erhältlich	
214426-	2.750 m Fußspule	5 Spulen
	<b>Rasant Oxella 30</b> in 37 Farben erhältlich	
214460-	2.500 m Fußspule	5 Spulen
	<b>Rasant Oxella 35</b> in 60 Farben erhältlich	
114028-	4.000 m Fußspule	5 Spulen
	<b>Rasant 35</b> roh / matt in 52 Farben erhältlich	
114035-	3.000 m Cone	5 Conen
	<b>Rasant 50</b> roh / matt in 52 Farben erhältlich	
114007-	1.000 m Rolle	10 Rollen
114027-	5.000 m Cone	5 Conen
	<b>Saba</b> – Nähgarn aus 100% Polyester	
114062-	<b>Saba 30</b> 300 m Rolle in 500 Farben erhältlich	10 Rollen
114065-	<b>Saba 50</b> 500 m Rolle in 500 Farben erhältlich	10 Rollen
	<b>OUTDOOR-PRO</b> – Nähgarn für Markisen, Verdecke etc.	
214564-	<b>10</b> 1.400 m Fußspule in 34 Farben erhältlich	1 Spule
214565-	<b>15</b> 1.900 m Fußspule in 34 Farben erhältlich	1 Spule
214560-	<b>20</b> 1.500 m Fußspule in 34 Farben erhältlich	1 Spule
214561-	<b>20</b> 3.000 m Fußspule in 34 Farben erhältlich	1 Spule
214562-	<b>30</b> 2.300 m Fußspule in 34 Farben erhältlich	1 Spule
214563-	<b>40</b> 5.500 m Fußspule in 34 Farben erhältlich	1 Spule
	<b>Tenara</b> – Nähgarn aus ePTFE – extrem UV-, witterungs- und chemikalienbeständig, für Markisen, Verdecke etc.	
	<b>Tenara M 1000 TR</b> Fadenstärke 35 – 40	
214003-	1.750 m Rolle in 11 Farben erhältlich	1 Rolle
	<b>Tenara M 1000 LTR</b> Fadenstärke 50 – 60	
214004	2.100 m Rolle Farbe »clear«	1 Rolle

Serafil **RECYCLED** – nachhaltiger Nähfaden, hergestellt aus 100% recycelten PET-Flaschen, auf Anfrage lieferbar.

Weitere Stärken » 11, 15, 20 « Rasant Oxella auf Anfrage lieferbar.

Saba **RECYCLED** – nachhaltiger Nähfaden, hergestellt aus 100% recycelten PET-Flaschen, auf Anfrage lieferbar.

## Farbnummern für Reißverschluss Typ 0 und Schieber

 190 weiß	 100 schwarz	 180 braun	 137 rot
 182 sekt	 191 hellgrau	 188 dunkelbraun	 252 gelb
 181 beige	 193 grau	 246 lachs	 876 grün
 264 rötlich beige	 2232 silbergrau	 250 pfirsich	 161 dunkelblau
091126	<b>Musterkarte</b> (Farbkarte) 16 Farben		1 Stück
091122-1	<b>Farbblatt</b> 16 Farben		1 Stück

### Kunststoff-Reißverschluss Typ 0 Industrierausführung – Kette verschweißt (Lagerware)

16 Farben, siehe oben



124030-	30 cm lang	10 Stück
124035-	35 cm lang	10 Stück
124040-	40 cm lang	10 Stück
124150-	50 cm lang	10 Stück
124155-	55 cm lang	10 Stück
124160-	60 cm lang	10 Stück
124170-	70 cm lang	10 Stück
124180-	80 cm lang	10 Stück
124190-	90 cm lang	10 Stück
124100-	100 cm lang	10 Stück

Bitte ergänzen Sie die Art.-Nr. mit der von Ihnen gewünschten Farbnummer.

### Kunststoff-Reißverschluss Typ 0 Rollenware – 50 m Endlos (Lagerware)

16 Farben, siehe oben

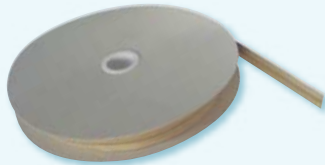

124502-	50 m	250 m
124500-	250 m Endlos	250 m

Bitte ergänzen Sie die Art.-Nr. mit der von Ihnen gewünschten Farbnummer.

### Kunststoff-Reißverschluss Typ 0 Rollenware – 50 m Endlos

228 Farben (ca. 14 Tage Lieferzeit)

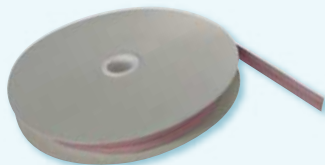

124501-	50 m	50 m
---------	------	------

### Reißverschluss-Schieber

passend zu Reißverschluss Typ 0

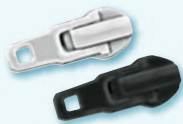

124600	silberfarbig	100 Stück
124602-	farbig	100 Stück
		500 Stück
		1000 Stück

Bitte ergänzen Sie die Art.-Nr. mit der von Ihnen gewünschten Farbnummer.

124603	Griff Tropfenform, silberfarbig	100 Stück
--------	---------------------------------	-----------

### Aufzuggerät für Reißverschlüsse Typ 0



124601	mit Schraubloch	1 Stück
124605	mit Tischklemme, dreh- und höhenverstellbar	1 Stück



124610	<b>Reißverschluss-Zange</b> zum Setzen von Endteilen	1 Stück
--------	------------------------------------------------------	---------

124611	<b>Endteilkammern</b> für 4 bis 5 mm Kettenbreite	5.000 Stück
--------	---------------------------------------------------	-------------



Art.-Nr. Artikel-Bezeichnung VE



## Reißverschluss für Bettwäsche

24 mm breit

124503-	80 cm lang mit 2 Schiebern	(weiß oder beige)	3 Stück
124504-1	135 cm lang mit 1 Schieber	(nur weiß)	3 Stück
124505-1	155 cm lang mit 1 Schieber	(nur weiß)	3 Stück
124506-	10 m lang mit 15 Schiebern	(weiß oder beige)	1 VE

Farb-Nr.: -1 weiß  
 -2 beige



## Reißverschluss-Schieber für Bettwäsche, ohne Griff

124604	silberfarbig	100 Stück
--------	--------------	-----------



## Kunststoff-Reißverschluss Typ 10

30 mm breit

124710-	Rollenware – Endlos, farbig	40 m
---------	-----------------------------	------

Farb-Nr.: -0190 weiß (5400) -0181 beige (5910)  
 -5406 creme AV -0264 rot-beige (5940)  
 -0182 sekt (5410) -0180 braun (5972)  
 -0193 grau (5434) -0188 dunkelbraun (5981)  
 -0100 schwarz (5460) -2232 silbergrau



## Reißverschluss-Schieber für Reißverschluss Typ 10 (124 710)

124713	silberfarbig + farbig (Farbnummern s. oben, nach Verfügbarkeit)	100 Stück
--------	-----------------------------------------------------------------	-----------



## Taschenreißverschluss (Kunststoff)

30 mm breit, Kette 6,2 mm

124510-	Rollenware – Fixmaß	1 m 40 m 250 m
---------	---------------------	----------------------

Farb-Nr.: -0190 weiß (5400) -0191 grau  
 -0100 schwarz (5460) -0181 beige  
 -0188 dunkelbraun (5981)



## Reißverschluss-Schieber für Taschenreißverschluss (124 510)

124513	Einfach-Schieber	vernickelt, silberfarbig	100 Stück
124513-	Einfach-Schieber	weiß -0190, schwarz -0100	100 Stück
124514 AV	Doppelgriff-Schieber	vernickelt, silberfarbig	1 Stück



## Reißverschluss TEILBAR (Kunststoff)

32 mm breit, mit farbigen Schiebern

124260-	60 cm lang	1 Stück
124280-	80 cm lang	1 Stück
124210-	100 cm lang	1 Stück
124220-	200 cm lang	1 Stück

Farb-Nr.: -0190 weiß (5400)  
 -0100 schwarz (5460)  
 -0181 beige (5910)  
 -0188 dunkelbraun (5981)  
 -2232 silbergrau



## Zeltreißverschluss (Kunststoff)

38 mm breit, Kette 8,1 mm

124615-	Rollenware – Fixmaß	1 m 25 m 200 m
---------	---------------------	----------------------

Farb-Nr.: -0190 weiß (5400)  
 -0100 schwarz (5460)  
 -0188 dunkelbraun (5981)



## Reißverschluss-Schieber für Zeltreißverschluss (124 615)

124618	Einfach-Schieber	vernickelt, silberfarbig	1 Stück
124619	Doppelgriff-Schieber	vernickelt, silberfarbig	1 Stück

Art.-Nr. Artikel-Bezeichnung VE

## Klettband 10 mm breit

### aufnäher

113613	Hakenband	einzel	weiß		50 m
113611	Flauschband	einzel	weiß		50 m
113620	Hakenband	einzel	weiß		50 m
113619	Flauschband	einzel	weiß		50 m

### selbstklebend

113610	Hakenband	einzel	weiß		50 m
113612	Flauschband	einzel	weiß		50 m

## Klettband 20 mm breit

### aufnäher

113500	Haken und Flausch	komplett	weiß		25 m
113501	Hakenband	einzel	weiß		25 m
113503	Flauschband	einzel	weiß		25 m
113506-1	Hakenband	einzel	schwarz		25 m
113505-1	Flauschband	einzel	schwarz		25 m
113506-6	Hakenband	einzel	dunkelgrau		25 m
113505-117	Flauschband	einzel	dunkelgrau		25 m
113506-18	Hakenband	einzel	grau		25 m
113505-18	Flauschband	einzel	grau		25 m
113506-2	Hakenband	einzel	braun		25 m
113505-2	Flauschband	einzel	braun		25 m
113506-5	Hakenband	einzel	beige		25 m
113505-3	Flauschband	einzel	beige		25 m
113506-24	Hakenband	einzel	grün		25 m
113505-24	Flauschband	einzel	grün		25 m
113506-10	Hakenband	einzel	bordeaux		25 m
113505-10	Flauschband	einzel	bordeaux		25 m

**Weitere Farben lieferbar:** natur, hautfarben, havana-braun, marineblau, hellblau, königsblau, dunkelgrün, oliv, armee-grün, rot, rostrot, orange, gelb, neongelb, neonorange, neonpink

### selbstklebend

113502	Hakenband	einzel	weiß		25 m
113508	Flauschband	einzel	weiß		25 m
113507-3	Hakenband	einzel	schwarz		25 m
113504-3	Flauschband	einzel	schwarz		25 m
113507-4	Hakenband	einzel	grau		25 m
113504-2	Flauschband	einzel	grau		25 m
113507-5	Hakenband	einzel	beige		25 m
113504-1	Flauschband	einzel	beige		25 m
113504-4 <sup>AV</sup>	Flauschband	einzel	braun		25 m

### aufbügelbar

113510	Flauschband	einzel	weiß		100 m
--------	-------------	--------	------	--	-------

## Klettband 30 mm breit

### aufnäher

113519	Hakenband	einzel	weiß		25 m
113511	Flauschband	einzel	weiß		25 m
113526-1	Hakenband	einzel	schwarz		25 m
113512-1	Flauschband	einzel	schwarz		25 m
113526-6	Hakenband	einzel	grau		25 m
113512-6	Flauschband	einzel	grau		25 m
113526-2	Hakenband	einzel	beige		25 m
113512-2	Flauschband	einzel	beige		25 m

### selbstklebend

113520	Hakenband	einzel	weiß		25 m
113517	Flauschband	einzel	weiß		25 m
113520-1	Hakenband	einzel	schwarz		25 m
113517-1	Flauschband	einzel	schwarz		25 m
113520-3	Hakenband	einzel	grau		25 m
113518-3	Flauschband	einzel	grau		25 m
113520-2	Hakenband	einzel	beige		25 m
113518-2	Flauschband	einzel	beige		25 m



Farbkarten finden Sie unter [ed-altena.de/farbkarten](http://ed-altena.de/farbkarten)

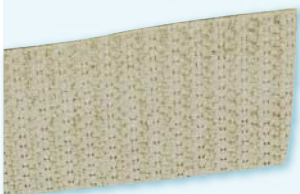

Art.-Nr. Artikel-Bezeichnung VE

## Polsterklettband 50 mm breit

### aufnähar

230400-1	Hakenband	einzel	weiß		25 m	
230400-2	Flauschband	einzel	weiß		25 m	
230407-1	Hakenband	einzel	schwarz		25 m	
230407-2	Flauschband	einzel	schwarz		25 m	
230408-1	Hakenband	einzel	grau		25 m	
230408-2	Flauschband	einzel	grau		25 m	
230406-1	Hakenband	einzel	braun		25 m	
230406-2	Flauschband	einzel	braun		25 m	
230405-1	Hakenband	einzel	beige		25 m	
230405-2	Flauschband	einzel	beige		25 m	

### selbstklebend

230409-1	Hakenband	einzel	weiß		25 m	
230409-2	Flauschband	einzel	weiß		25 m	
230409-3	Hakenband	einzel	schwarz		25 m	
230409-4	Flauschband	einzel	schwarz		25 m	
230409-9	Hakenband	einzel	grau		25 m	
230409-10	Flauschband	einzel	grau		25 m	
230409-7	Hakenband	einzel	beige		25 m	
230409-8	Flauschband	einzel	beige		25 m	

## »Super-Klett« Klettband 50 mm breit

50% größere Kraft gegenüber Standardprodukten, wasserbeständiger Klebstoff

### selbstklebend

230411	Haken und Flausch komplett		weiß		25 m	
230411-2	Hakenband	einzel	weiß		25 m	
230411-1	Flauschband	einzel	weiß		25 m	

## Polsterklettband 100 mm breit

### aufnähar

113521-1	Hakenband	einzel	weiß		25 m	
113521-2	Flauschband	einzel	weiß		25 m	
113522-1	Hakenband	einzel	schwarz		25 m	
113522-2	Flauschband	einzel	schwarz		25 m	

## Klettband 20 mm breit

licht- und alterungsbeständig, besonders geeignet für Wintergärten

### Hakenband

113618	selbstklebend		weiß		25 m	
--------	---------------	--	------	--	------	--

### Flauschband »PE«

099699	aufnähar		weiß		1 m 25 m	
--------	----------	--	------	--	-------------	--







## Kunststoff- und Metallösen

ab Seite D 424



## Bad-Zubehör

Seite D 431

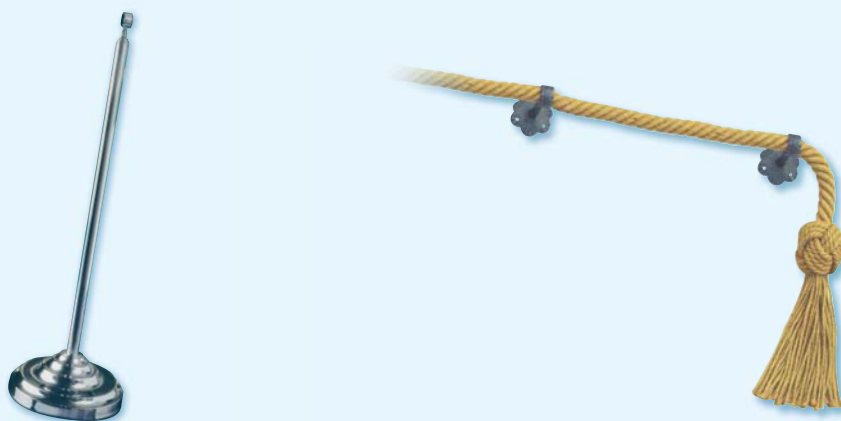

## Dekorations-Seil

ab Seite D 432

Art.-Nr.    Innen-Ø    Außen-Ø    Stanzloch-Ø    VE

## Deko-Kunststoff-Ösen »Rund« metallisiert

### chrom glänzend

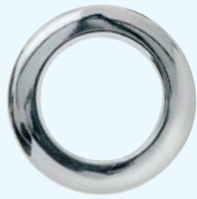

115073-12	<b>20 mm</b>	36 mm	24 mm	100 Stück
115077-12	<b>28 mm</b>	46 mm	33 mm	100 Stück
115071-12	<b>35 mm</b>	55 mm	40 mm	100 Stück
115079-12	<b>50 mm</b>	72 mm	55 mm	100 Stück

### chrom matt



115075-17 <sup>AV</sup>	<b>10 mm</b>	25 mm	14 mm	100 Stück
115073-17	<b>20 mm</b>	36 mm	24 mm	100 Stück
115077-17	<b>28 mm</b>	46 mm	33 mm	100 Stück
115071-17	<b>35 mm</b>	55 mm	40 mm	100 Stück
115079-17	<b>50 mm</b>	72 mm	55 mm	100 Stück

### messing glänzend



115073-13	<b>20 mm</b>	36 mm	24 mm	100 Stück
115077-13	<b>28 mm</b>	46 mm	33 mm	100 Stück
115071-13	<b>35 mm</b>	55 mm	40 mm	100 Stück

### messing matt



115077-19	<b>28 mm</b>	46 mm	33 mm	100 Stück
115071-19	<b>35 mm</b>	55 mm	40 mm	100 Stück
115079-19	<b>50 mm</b>	72 mm	55 mm	100 Stück

### edelstahl matt



115075-18 <sup>AV</sup>	<b>10 mm</b>	25 mm	14 mm	100 Stück
115073-18	<b>20 mm</b>	36 mm	24 mm	100 Stück
115077-18	<b>28 mm</b>	46 mm	33 mm	100 Stück
115071-18	<b>35 mm</b>	55 mm	40 mm	100 Stück
115079-18	<b>50 mm</b>	72 mm	55 mm	100 Stück

### messing antik



115073-21	<b>20 mm</b>	36 mm	24 mm	100 Stück
115077-21	<b>28 mm</b>	46 mm	33 mm	100 Stück
115071-21	<b>35 mm</b>	55 mm	40 mm	100 Stück
115079-21	<b>50 mm</b>	72 mm	55 mm	100 Stück

### bronziert



115073-20	<b>20 mm</b>	36 mm	24 mm	100 Stück
115077-20	<b>28 mm</b>	46 mm	33 mm	100 Stück
115071-20	<b>35 mm</b>	55 mm	40 mm	100 Stück

### granit metallic



115077-14	<b>28 mm</b>	46 mm	33 mm	100 Stück
115071-14	<b>35 mm</b>	55 mm	40 mm	100 Stück

Art.-Nr.    Innen-Ø    Außen-Ø    Stanzloch-Ø    VE

## Deko-Kunststoff-Ösen »Rund«

### weiß



115074-1	<b>10 mm</b>	25 mm	14 mm	100 Stück
115076-1	<b>28 mm</b>	46 mm	33 mm	100 Stück
115070-1	<b>35 mm</b>	55 mm	40 mm	100 Stück

### schwarz



115074-2 <sup>AV</sup>	<b>10 mm</b>	25 mm	14 mm	100 Stück
115072-2	<b>20 mm</b>	36 mm	24 mm	100 Stück
115076-2	<b>28 mm</b>	46 mm	33 mm	100 Stück
115070-2	<b>35 mm</b>	55 mm	40 mm	100 Stück

### glasklar



115076-10	<b>28 mm</b>	46 mm	33 mm	100 Stück
115070-10	<b>35 mm</b>	55 mm	40 mm	100 Stück

## Deko-Kunststoff-Ösen »Viereck«

Innen-Ø    Stanzloch-Ø



### 35 mm

115049-18 <sup>AV</sup>	edelstahl		40 mm	100 Stück
115049-19 <sup>AV</sup>	messing matt		40 mm	100 Stück

## Ringstopper für 16 und 20 mm Ø Rohr



126520	transparent		10 Stück
--------	-------------	--	----------

## Wäschenet mit Reißverschluss 100% Polyester, ideal für die Waschtrommel



305103	70 x 50 cm	1 Stück 5 Stück
--------	------------	--------------------

## Wäschenet »Ei-Form« mit Reißverschluss 100% Polyester, ideale Form für die Waschtrommel



305116	ca. 80 x 56 cm	1 Stück 20 Stück
--------	----------------	---------------------

ohne Thekendisplay

## Waschanleitung – bitte unbedingt beachten:

Stoff-Ösenvorhänge stets in einem Wäschenet bei max. 30° C waschen, da sonst die Ösen durch Schlagen an die Trommel beschädigt werden können.

Keine chemische Reinigung!





# ED Messing-Ösen und Scheiben für Handeinschlagwerkzeug + Maschinen

Art.-Nr.	Innen-Ø	Außen-Ø	Höhe	VE
<b>messing</b>				
318510	<b>10 mm</b>	19,0 mm	5,9 mm	100 St. 1000 St.
318512	<b>12 mm</b> DIN 12	24,0 mm	6,5 mm	100 St. 1000 St.
318520	<b>20 mm</b>	36,0 mm	8,2 mm	100 St. 1000 St.
318525	<b>25 mm</b>	43,9 mm	10,6 mm	100 St. 1000 St.
318529	<b>29 mm</b>	48,1 mm	9,5 mm	100 St. 1000 St.
318540	<b>40 mm</b>	62,0 mm	12,5 mm	100 St. 1000 St.
<b>messing matt satiniert</b>				
318520-19 <sub>AV</sub>	<b>20 mm</b>	36,0 mm	8,2 mm	100 St. 1000 St.
318525-19	<b>25 mm</b>	43,9 mm	10,6 mm	100 St. 1000 St.
318529-19	<b>29 mm</b>	48,1 mm	9,5 mm	100 St. 1000 St.
318540-19	<b>40 mm</b>	62,0 mm	12,5 mm	100 St. 1000 St.
318566-19	<b>66 mm</b>	95,0 mm	13,0 mm	50 St. 250 St.
<b>vernickelt</b>				
318505-12	<b>5 mm</b> selbstschneidend	9,5 mm	5,3 mm	500 St. 5000 St.
318508-12	<b>8 mm</b> DIN 8	16,0 mm	5,8 mm	1000 St.
318510-12	<b>10 mm</b>	19,0 mm	5,9 mm	100 St. 1000 St.
318510-10	<b>10 mm</b> DIN 10	20,0 mm	6,4 mm	100 St.
318513-12	<b>12 mm</b> selbstschneidend	25,0 mm	6,2 mm	100 St. 1000 St.
318512-12	<b>12 mm</b> DIN 12	24,0 mm	6,5 mm	100 St. 1000 St.
317414	<b>14 mm</b> DIN 14	27,5 mm	8,0 mm	100 St.
318515-12	<b>15 mm</b>	28,5 mm	6,3 mm	100 St. 1000 St.
317416	<b>16 mm</b> DIN 16	30,0 mm	8,8 mm	100 St.
317318	<b>18 mm</b> DIN 18	32,0 mm	9,1 mm	100 St.
318520-12	<b>20 mm</b>	36,0 mm	8,2 mm	100 St. 1000 St.
318525-12	<b>25 mm</b>	43,9 mm	10,6 mm	100 St. 1000 St.
318529-12	<b>29 mm</b>	48,1 mm	9,5 mm	100 St. 1000 St.
317336	<b>36 mm</b> für Handeinschlagwerkzeug	60,0 mm	13,1 mm	100 St.
318540-12	<b>40 mm</b>	62,0 mm	12,5 mm	100 St. 1000 St.
317314	<b>40 mm</b> mit Zahnscheibe	62,0 mm	12,5 mm	100 St. 1000 St.
318566-12	<b>66 mm</b>	95,0 mm	13,0 mm	50 St. 250 St.
<b>anthrazit</b>				
318512-02	<b>12 mm</b> DIN 12	24,0 mm	6,5 mm	100 St. 1000 St.
318515-38	<b>15 mm</b>	28,5 mm	6,3 mm	100 St. 1000 St.
318520-38	<b>20 mm</b>	36,0 mm	8,2 mm	100 St. 1000 St.
318525-38	<b>25 mm</b>	43,9 mm	10,6 mm	100 St. 1000 St.



Art.-Nr.	Innen-Ø	Außen-Ø	Höhe	VE	
<b>schwarz matt galvanisiert</b>					
	318508-03	<b>8 mm</b>	16,0 mm	5,8 mm	1000 St.
	318525-03	<b>25 mm</b>	43,9 mm	10,6 mm	100 St. 1000 St.
	318525-04	<b>25 mm</b> mit Zahnscheibe	44,0 mm	10,5 mm	100 St. 1000 St.
	318529-03	<b>29 mm</b> für Maschinenwerkzeug	48,1 mm	9,5 mm	100 St. 1000 St.
	318529-04	<b>29 mm</b> mit Zahnscheibe	48,0 mm	9,5 mm	100 St. 1000 St.
	318540-04	<b>40 mm</b> mit Zahnscheibe	63,0 mm	12,5 mm	100 St. 1000 St.
	318540-03	<b>40 mm</b> grau-schwarz galvanisiert	62,0 mm	12,5 mm	100 St. 1000 St.
	318566-03	<b>66 mm</b>	95,0 mm	13,0 mm	50 St. 250 St.
<b>edelstahl matt satiniert</b>					
	318520-18	<b>20 mm</b>	36,0 mm	8,2 mm	100 St. 1000 St.
	318525-18	<b>25 mm</b>	43,9 mm	10,6 mm	100 St. 1000 St.
	318529-18	<b>29 mm</b>	48,1 mm	9,5 mm	100 St. 1000 St.
	318540-18	<b>40 mm</b>	62,0 mm	12,5 mm	100 St. 1000 St.
	318566-18	<b>66 mm</b>	95,0 mm	13,0 mm	50 St. 250 St.
<b>altmessing brüniert</b>					
	318525-21	<b>25 mm</b>	43,9 mm	10,6 mm	100 St. 1000 St.
	318529-21	<b>29 mm</b>	48,1 mm	9,5 mm	100 St. 1000 St.
	318540-21	<b>40 mm</b>	62,0 mm	12,5 mm	100 St. 1000 St.
	318566-21	<b>66 mm</b>	95,0 mm	13,0 mm	50 St. 250 St.
<b>altkupfer matt</b>					
	318525-39	<b>25 mm</b>	43,9 mm	10,6 mm	100 St. 1000 St.
	318529-39	<b>29 mm</b>	48,1 mm	9,5 mm	100 St. 1000 St.
	318540-39	<b>40 mm</b>	62,0 mm	12,5 mm	100 St. 1000 St.
<b>ED NiRo - Ösen und Scheiben</b>					
<b>Edelstahl</b>					
	318508-40	<b>8 mm</b> DIN 8	16,0 mm	5,8 mm	1000 St.
	318510-40	<b>10 mm</b> DIN 10	20,0 mm	6,4 mm	100 St. 1000 St.
	318512-40	<b>12 mm</b> DIN 12	24,0 mm	6,5 mm	100 St. 1000 St.
	314318	<b>18 mm</b>	32,0 mm	9,1 mm	100 St. 1000 St.
	318525-40	<b>25 mm</b>	43,9 mm	10,6 mm	100 St. 1000 St.
	318540-40	<b>40 mm</b>	62,0 mm	13,0 mm	100 St. 1000 St.

Verarbeitungswerkzeuge für Metallösen finden Sie in unserem Werkzeugkatalog auf den Seiten W 83 und W 84.



# B Messing-Ösen und Scheiben

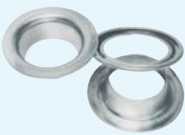

Art.-Nr.	Innen-Ø	Außen-Ø	Höhe	VE
<b>messing</b>				
317814-1	<b>5 mm</b>	11,0 mm	4,5 mm	500 St.
317100	<b>B 0 = 8 mm</b>	13,0 mm	5,2 mm	200 St. 1000 St.
317102	<b>B 2 = 10 mm</b>	16,0 mm	6,1 mm	200 St. 1000 St.
317103	<b>B 3 = 11 mm</b>	17,5 mm	6,0 mm	200 St. 1000 St.
317104	<b>B 4 = 12 mm</b>	19,5 mm	6,5 mm	200 St. 1000 St.
317106	<b>B 6 = 13 mm</b>	22,5 mm	7,3 mm	200 St. 1000 St.
317108	<b>B 8 = 15 mm</b>	25,5 mm	8,0 mm	100 St. 1000 St.
317110	<b>B 10 = 20 mm</b>	32,0 mm	9,7 mm	100 St. 1000 St.
317112	<b>B 12 = 24 mm</b>	38,0 mm	10,3 mm	100 St. 1000 St.
317117	<b>B 14 = 29 mm</b>	45,0 mm	11,8 mm	100 St. 1000 St.

<b>vernickelt</b>				
317814	<b>5 mm</b>	11,0 mm	4,5 mm	500 St.
317300	<b>B 0 = 8 mm</b>	13,0 mm	5,2 mm	200 St. 1000 St.
317300-L	B 0 mit langem Schaft		7,2 mm	100 St.
317301	<b>B 1 = 9 mm</b>	14,5 mm	5,4 mm	200 St. 1000 St.
317301-L	B 1 mit langem Schaft		7,0 mm	100 St.
317302	<b>B 2 = 10 mm</b>	16,0 mm	6,1 mm	200 St. 1000 St.
317302-L	B 2 mit langem Schaft		7,0 mm	100 St.
317303	<b>B 3 = 11 mm</b>	17,5 mm	6,0 mm	200 St. 1000 St.
317303-L	B 3 mit langem Schaft		7,0 mm	100 St.
317304	<b>B 4 = 12 mm</b>	19,5 mm	6,5 mm	200 St. 1000 St.
317304-L	B 4 mit langem Schaft		7,2 mm	100 St.
317305	<b>B 5 = 12 mm</b>	21,0 mm	7,0 mm	200 St. 1000 St.
317306	<b>B 6 = 13 mm</b>	22,5 mm	7,3 mm	200 St. 1000 St.
317308	<b>B 8 = 15 mm</b>	25,5 mm	8,0 mm	100 St. 1000 St.
317310	<b>B 10 = 20 mm</b>	32,0 mm	9,7 mm	100 St. 1000 St.
317312	<b>B 12 = 24 mm</b>	38,0 mm	10,3 mm	100 St. 1000 St.
317317	<b>B 14 = 29 mm</b>	45,0 mm	11,8 mm	100 St. 1000 St.

<b>brüniert</b>				
317814-2	<b>5 mm</b>	11,0 mm	4,5 mm	500 St.

B0 bis B14 Ösen in Brüniert und Altkupfer lieferbar.

Art.-Nr. Artikel-Bezeichnung VE

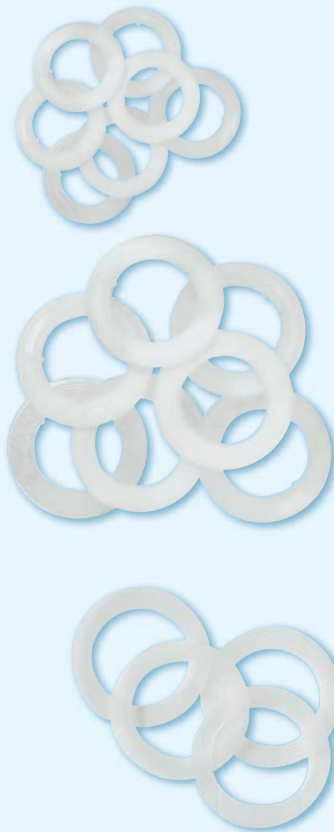

## Ösenverstärkungsringe 2 mm stark

Kunststoff, transparent

	317340	8 mm Ø (B 0 + B 1)	100 St. 1000 St.
	317341	10 mm Ø (B 2 + B 3)	100 St. 1000 St.
	317342	12 mm Ø (B 4 + B 6)	100 St. 1000 St.
	317343	16 mm Ø (B 8 + 15 mm)	100 St. 1000 St.
	317344	20 mm Ø (B 10 + 18 mm)	100 St. 1000 St.
	317345	25 mm Ø (B 12 + 25 mm)	100 St. 1000 St.
	317347	36 mm Ø	100 St. 1000 St.
	317346	40 mm Ø	100 St. 1000 St.

## Ösenverstärkungsringe 1 mm stark

Kunststoff, transparent, montiert unsichtbar

	317350	30 mm Ø (B 14 + 29 mm)	100 St. 1000 St.
	317346-1	40 mm Ø	100 St. 1000 St.

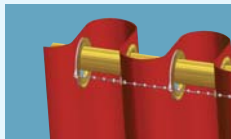

**WELLEN-Passring + Kugelkette** – die perfekte Welle mit Deko-Ösen auf Seite D 401. Passringe und Kugelkette bilden unsichtbar hinter dem Vorhang perfekte Wellen, der Passring wirkt zugleich wie ein Verstärkungsring.

## Ösenverstärkungsband

chemiereinigungs- und feinwaschbeständig, 100 m Rolle



### 50 mm breit

	113405	einseitig aufbügelbar	rohweiß	Gewebe	1 Rolle
--	--------	-----------------------	---------	--------	---------

### 75 mm breit

	113400	einseitig aufbügelbar	rohweiß	Gewebe	1 Rolle
	113401	doppelseitig aufbügelbar	rohweiß	Gewebe	1 Rolle
	113402	einseitig aufbügelbar	transparent	Polyester	1 Rolle
	113403	doppelseitig aufbügelbar	transparent	Polyester	1 Rolle
	104427	aufnähar	transparent	Polyester	1 Rolle
	104422	aufnähar	rohweiß	Vlies	1 Rolle

### 100 mm breit

	113411	einseitig aufbügelbar	rohweiß	Gewebe	1 Rolle
	113413	einseitig aufbügelbar	transparent	Polyester	1 Rolle

(Aufbügelbare Bänder mit Konfektionsbeschichtung zum Fixieren mit Dampf und Nachnähen.)

## Ösengleitring

40 mm Ø, Kunststoff, für alle Ösen mit 40 mm Innen-Ø, auch für Flachösen (Art.-Nr. 318543-) Die Gleitringe reduzieren das Laufgeräusch auf Vorhangstangen und verhindern dabei auch Kratzer, die beim Gleiten von Metall auf Metall entstehen.



	317348	transparent	100 St. 1000 St.
	317353	silber, u.a. für nickel, edelstahl	100 St. 1000 St.
	317355	schwarz, u.a. für gun, brüniert	100 St. 1000 St.



Art.-Nr.    Innen-Ø    Außen-Ø    Höhe    VE



- Messing-Ösen und Scheiben im neuen Design
- Elegante und puristische Formgebung, nur 8 mm breit
- Rückseite optisch ansprechend
- Bestens geeignet für die aktuellen, leichten Stoffe



### messing, glanz

318543	<b>40 mm</b>	56,0 mm	5,0 mm	100 St. 500 St. 1000 St.
--------	--------------	---------	--------	--------------------------------



### messing matt satiniert

318543-19	<b>40 mm</b>	56,0 mm	5,0 mm	100 St. 500 St. 1000 St.
-----------	--------------	---------	--------	--------------------------------



### vernickelt

318543-12	<b>40 mm</b>	56,0 mm	5,0 mm	100 St. 500 St. 1000 St.
-----------	--------------	---------	--------	--------------------------------



### edelstahl matt satiniert

318543-18	<b>40 mm</b>	56,0 mm	5,0 mm	100 St. 500 St. 1000 St.
-----------	--------------	---------	--------	--------------------------------



### altmessing brüniert

318543-21	<b>40 mm</b>	56,0 mm	5,0 mm	100 St. 500 St. 1000 St.
-----------	--------------	---------	--------	--------------------------------



### anthrazit

318543-38	<b>40 mm</b>	56,0 mm	5,0 mm	100 St. 500 St. 1000 St.
-----------	--------------	---------	--------	--------------------------------



### altkupfer matt

318543-39	<b>40 mm</b>	56,0 mm	5,0 mm	100 St. 500 St. 1000 St.
-----------	--------------	---------	--------	--------------------------------

## WERKZEUGE FÜR DIE VERARBEITUNG DER FLACHÖSEN

313 Handösenstanze, komplett, für Flachösen 40mm 318543-xx

316040	Henkelocheisen 40 mm Ø	1 St.
--------	------------------------	-------

319590	Schlaghaltegriff für Stoff-Stanzeisen von 22 – 42 mm	1 St.
--------	------------------------------------------------------	-------

319540	Stoff-Stanzeisen 40 mm Ø	1 St.
--------	--------------------------	-------











319603	Spezial Stanz- + Schlagplatte Größe ca. 23 x 23 x 5 cm	1 St.
--------	--------------------------------------------------------	-------

318743	Maschinen Werkzeug für Flachösen 40mm 318543-xx	1 St.
--------	-------------------------------------------------	-------

318940	Maschinen-Stoffstanzeisen 40 mm Ø	1 St.
--------	-----------------------------------	-------

091156	ED-Musterschal Flachösen Ösen + Scheiben, verschiedene Farben	1 St.
--------	---------------------------------------------------------------	-------



Art.-Nr.	Artikel-Bezeichnung	VE	
	<b>Universal-Winkelstange 20 mm Ø</b> Aluminium		
	2 gerade Rohre, 1 Rohr mit 90°-Bogen und 1 kurzer 90°-Bogen, mögliche Montage in den Maßen: 90 x 90 cm, 90 x 170 cm oder 90 x 100 x 90 cm		
510500	chrom	Klarsichtverpackung	
510501	weiß	Klarsichtverpackung	
			
	<b>Universal-Winkelstange mit Innenlauf und Deckenabhängung</b> Aluminium		
	2 gerade Profilschienen, 2 Profilschienen mit 90°-Bogen, 2 Stützstangen (60 cm – kürzbar), Wand- und Deckenträger, Profilverbinder, Gleiter, Haken, Feststeller, Schrauben und Dübel, mögliche Montage in den Maßen: 90 x 90 cm, 90 x 170 cm, 90 x 110 x 90 cm oder 90 x 185 x 90 cm		
510520	alu-matt	Klarsichtverpackung	
510519	weiß	Klarsichtverpackung	
			
	<b>130057-2 Karabinerhaken 40 mm, Edelstahl,</b> für ein bequemes Einhängen der Duschvorhänge	100 Stück	
	<b>Federstange 20 mm Ø</b> Aluminium		
510510	75 – 125 cm lang chrom	Klarsichtverpackung	
510511	weiß	Klarsichtverpackung	
510515	125 – 220 cm lang chrom	Klarsichtverpackung	
510516	weiß	Klarsichtverpackung	
	<b>Duschvorhang-Ringe</b> Kunststoff		
510530	glasklar	42 x 60 mm	12 Stück im Blister
510531	weiß	30 x 48 mm	12 Stück im Blister
510540	Ø 35 mm glasklar		12 Stück im Blister
510541	weiß		12 Stück im Blister
	<b>Duschvorhang-Ringe</b> Metall, chrom		
510551	Ø 35 mm		12 Stück im Blister
510550	Ø 35 mm, mit Kugeln		12 Stück im Blister
	<b>Duschvorhang</b> Polyester, wasserabweisend und schnelltrocknend, Beschwerungsband im Saum		
510570	weiß	180 cm breit, 200 cm hoch	Polybeutel
510575	weiß, PEVA (Poly-Vinyl)	240 cm breit, 180 cm hoch	Polybeutel
510576	weiß	240 cm breit, 180 cm hoch	Polybeutel
510574	weiß, Nadelstreifen	180 cm breit, 200 cm hoch	Polybeutel
510571	Flower, weiß, schwarz	180 cm breit, 200 cm hoch	Polybeutel
510572	Curve, weiß, schwarz	120 cm breit, 200 cm hoch	Polybeutel
510581	<b>Duschvorhangstoff, weiß</b>	208 cm breit	1 m 10 m

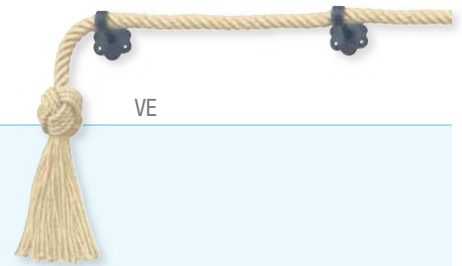

VE



Art.-Nr.	Artikel-Bezeichnung	Farbe	
<b>Dekorations-Seile</b>			
132000	30 mm Ø Hanf	natur	
132001	40 mm Ø Hanf	natur	
132010	30 mm Ø Polyacryl	rot	
132011	30 mm Ø Polyacryl	braun	
132013	30 mm Ø Polyacryl	schwarz	
132014	30 mm Ø Polyacryl	hellgrau	
132020	40 mm Ø Polyacryl	rot	
132021	40 mm Ø Polyacryl	braun	
132023	40 mm Ø Polyacryl	schwarz	
132024	40 mm Ø Polyacryl	hellgrau	

Polyacryl-Dekorations-Seile sind auch für den Außenbereich geeignet !

## Ansteckquasten



132120	30 mm Ø Hanf	natur		1 Stück
132121	40 mm Ø Hanf	natur		1 Stück
132130	30 mm Ø Polyacryl	rot		1 Stück
132160	30 mm Ø Polyacryl	braun		1 Stück
132170	30 mm Ø Polyacryl	schwarz		1 Stück
132190	30 mm Ø Polyacryl	hellgrau		1 Stück
132131	40 mm Ø Polyacryl	rot		1 Stück
132161	40 mm Ø Polyacryl	braun		1 Stück
132171	40 mm Ø Polyacryl	schwarz		1 Stück
132191	40 mm Ø Polyacryl	hellgrau		1 Stück

Die Seilbeschläge sind ausschließlich für Dekorationszwecke bestimmt.

## Seilhalter, Messing mit Stockschraube M 8, Wandabstand 70 mm



132050	30 mm Ø, messing-glanz		1 Stück
132040	30 mm Ø, nickel-matt		1 Stück
132074	30 mm Ø, verchromt		1 Stück
132060	40 mm Ø, messing-glanz		1 Stück
132041	40 mm Ø, nickel-matt		1 Stück
132075	40 mm Ø, verchromt		1 Stück

## Seilhalter, Messing (Innenecke)



132052	30 mm Ø, messing-glanz		1 Stück
132042	30 mm Ø, nickel-matt		1 Stück
132062	40 mm Ø, messing-glanz		1 Stück

## Seilhalter, Messing (Außenecke)



132054	30 mm Ø, messing-glanz		1 Stück
132055	30 mm Ø, nickel-matt		1 Stück
132064	40 mm Ø, messing-glanz		1 Stück

## Seilhalter geschmiedet, Wandabstand 55 mm, mit 2 Zierschrauben (132184)



132051	30 mm Ø, anthrazit		1 Stück
132061	40 mm Ø, anthrazit		1 Stück

Art.-Nr. Artikel-Bezeichnung VE

## Seilendkappe, Messing, ohne Ring

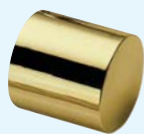

132070	30 mm Ø, messing-glanz		1 Stück
132043	30 mm Ø, nickel-matt		1 Stück
132087	30 mm Ø, verchromt		1 Stück
132080	40 mm Ø, messing-glanz		1 Stück
132044	40 mm Ø, nickel-matt		1 Stück
132089	40 mm Ø, verchromt		1 Stück

## Seilendkappe, Messing, mit Ring



132090	30 mm Ø, messing-glanz		1 Stück
132046	30 mm Ø, nickel-matt		1 Stück
132097	30 mm Ø, verchromt		1 Stück
132100	40 mm Ø, messing-glanz		1 Stück
132047	40 mm Ø, nickel-matt		1 Stück
132098	40 mm Ø, verchromt		1 Stück

## Aufhängehaken, Messing, eckig



132110	messing-glanz		1 Stück
132048	nickel-matt		1 Stück
132115	verchromt		1 Stück

## Seilendkappe, geschmiedet, ohne Ring

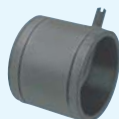

132071	30 mm Ø, anthrazit		1 Stück
--------	--------------------	--	---------

## Seilendkappe, geschmiedet, mit Ring



132091	30 mm Ø, anthrazit		1 Stück
--------	--------------------	--	---------

## Aufhängehaken, geschmiedet mit 2 Zierschrauben (132184)



132111	Rosette 60 mm Ø, anthrazit		1 Stück
--------	----------------------------	--	---------

## Zierschraube, geschmiedet Schlitz



132184	5 x 50 mm, anthrazit		1 Stück 100 Stück
--------	----------------------	--	----------------------

## Seilständer

Höhe 870 mm, Standfuß 260 mm Ø, Gewicht ca. 5 kg



<b>mit 2 Haken</b>			
132210	messing-glanz		1 Stück
132220	verchromt		1 Stück
<b>mit Seilöse</b>			
132211	30 mm Ø, messing-glanz		1 Stück
132221	30 mm Ø, verchromt		1 Stück
132212	40 mm Ø, messing-glanz		1 Stück
132222	40 mm Ø, verchromt		1 Stück

Die Seilbeschläge sind ausschließlich für Dekorationszwecke bestimmt und daher für große Belastungen, die bei der Verwendung als Handlaufseil entstehen könnten, nicht geeignet. Wir empfehlen, bei der Verwendung von Haltern und Endkappen, die Seile vorzubohren.

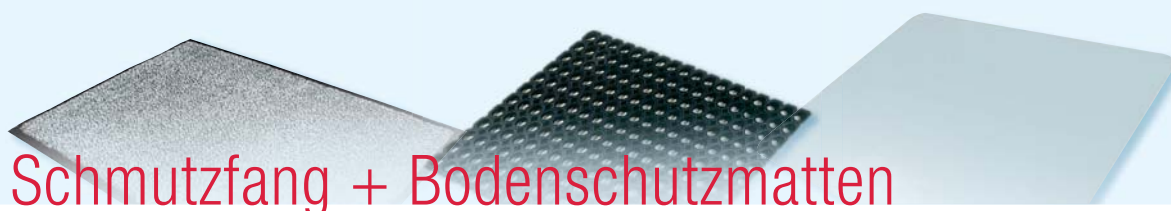

## Schmutzfang + Bodenschutzmatten

ab Seite D 436



## Türstopper

ab Seite D 440



## Möbelgleiter + Rollen

ab Seite D 442



## Treppenläuferstangen

ab Seite D 446



## Dübel + Schrauben

ab Seite D 450



Art.-Nr.



Artikel-Bezeichnung



VE



## Schmutzfangmatte für den Außenbereich

Robuste Schmutzfangmatte, ein Vinylgewebe verhindert, dass grobe Sand- und Kieskörner ins Gebäudeinnere dringen, mit rutschhemmenden Vinyl-Rücken.

122314-1	60 x 90 cm	schwarz		1 Stück
122314-2	60 x 90 cm	grau		1 Stück

122316-1	120 x 180 cm	schwarz		1 Stück
122316-2	120 x 180 cm	grau		1 Stück

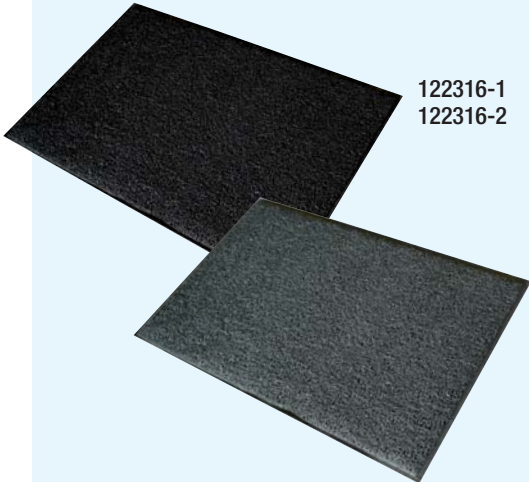



## Gummiwabenmatte

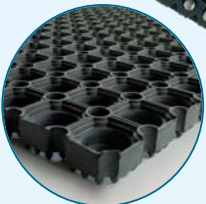
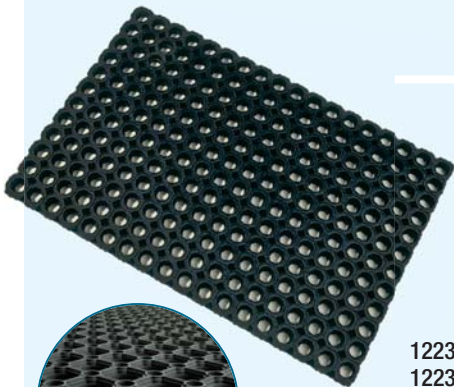

100% Gummi, für den Außen- und Nassbereich

Haltbar, strapazierfähig und ideal bei schwierigen Wetterverhältnissen (Regen oder Schnee); verknüpfen Sie mehrere Matten miteinander und setzen Sie ggf. Kratzbürsten für effektiveres Abschaben von Schmutz ein.



122321	60 x 80 cm	schwarz		1 Stück
122322	80 x 120 cm	schwarz		1 Stück
122323	100 x 150 cm	schwarz		1 Stück



122324	<b>Verbinder</b>	schwarz		10 Stück 
--------	------------------	---------	--------------------------------------------------------------------------------------	------------------------------------------------------------------------------------------------



122325-1	<b>Bürsteneinsatz</b>	schwarz		10 Stück 
----------	-----------------------	---------	--------------------------------------------------------------------------------------	------------------------------------------------------------------------------------------------

Art.-Nr. Artikel-Bezeichnung VE



## Schmutzfangmatte für den Innenbereich

Fasern: 100% Polypropylen – rutschhemmender Vinyl-Rücken, Polypropylenfasern fangen Schmutzpartikel; rutschfest und leicht zu reinigen

122301-2	60 x 90 cm	schwarz/weiß meliert		1 Stück
122301-3	60 x 90 cm	blau meliert		1 Stück
122302-2	90 x 120 cm	schwarz/weiß meliert		1 Stück
122302-3	90 x 120 cm	blau meliert		1 Stück
122303-2	90 x 150 cm	schwarz/weiß meliert		1 Stück
122303-3	90 x 150 cm	blau meliert		1 Stück
122304-2	120 x 180 cm	schwarz/weiß meliert		1 Stück
122304-3	120 x 180 cm	blau meliert		1 Stück



## Schmutzfangmatte für den Innenbereich

Flor für den optimalen Schutz vor Nässe: Kombination aus 70 % Mikrofaser und 30 % ultrastarker Polypropylen-Kratzfaser – rutschhemmender Vinyl/Gummi-Rücken

122317-2	60 x 90 cm	grau		1 Stück
122317-3	60 x 90 cm	braun		1 Stück
122318-2	90 x 150 cm	grau		1 Stück
122318-3	90 x 150 cm	braun		1 Stück
122319-2	90 x 300 cm	grau		1 Stück
122319-3	90 x 300 cm	braun		1 Stück
122329-2	120 x 180 cm	grau		1 Stück
122329-3	120 x 180 cm	braun		1 Stück



Ein doppeltes Schmutzfangmattensystem im Eingangsbereich wirkt wahre Wunder gegen Schmutz und Nässe.

Die Matten für den Außenbereich sind dazu da, den größten Schmutz von Ihrem Schuhwerk abzustreifen und saugen bei nassen Schuhen

das Wasser größtenteils auf, wodurch ein starkes Eindringen von Schmutz und Nässe in den Innenbereich verhindert wird.

Die Matten für den Innenbereich erledigen den Rest, indem Sie die übrige Feuchtigkeit aufsaugen und kleinere Schmutzpartikel vom Schuhwerk entfernen.

# Bodenschutzmatten für Hartfußböden

Art.-Nr. Artikel-Bezeichnung VE



## Bodenschutzmatten

**Unterseite ohne Ankerknoppen** – speziell für harte Böden, wie Laminat, Parkett, Holz- und Steinböden, sowie sehr niederflorige Teppichböden

Aus hochwertigem Polycarbonat, mit optimaler Bodenhaftung.

Die Matten 122 059, 122 071, 122 094, 122 074 und 122 063 verfügen zusätzlich über eine Anti-Rutsch-Beschichtung, diese empfehlen wir für sehr niederflorige Teppichböden und für sehr glatte und polierte Böden.

122081	119 x 89 cm	Rechteck mit Lippe	transparent	1 Stück
122085	120 x 134 cm	Rechteck mit Lippe	transparent	1 Stück
122082	99 x 125 cm	Kontur	transparent	1 Stück
122084	119 x 75 cm	Rechteck	transparent	1 Stück
122059	119 x 75 cm	Rechteck mit Anti-Rutsch	transparent	1 Stück
122086	119 x 89 cm	Rechteck	transparent	1 Stück
122071	119 x 89 cm	Rechteck mit Anti-Rutsch	transparent	1 Stück
122072	120 x 100 cm	Rechteck	transparent	1 Stück
122087	120 x 134 cm	Rechteck	transparent	1 Stück
122094	120 x 134 cm	Rechteck mit Anti-Rutsch	transparent	1 Stück
122099	120 x 150 cm	Rechteck	transparent	1 Stück
122074	120 x 150 cm	Rechteck mit Anti-Rutsch	transparent	1 Stück
122096	120 x 183 cm	Rechteck	transparent	1 Stück
122076	120 x 200 cm	Rechteck	transparent	1 Stück
122060	150 x 200 cm	Rechteck	transparent	1 Stück
122075	180 x 200 cm	Rechteck	transparent	1 Stück
122077	120 x 300 cm	Rechteck	transparent	1 Stück
122079	150 x 300 cm	Rechteck	transparent	1 Stück
122073	120 x 120 cm	Quadrat	transparent	1 Stück
122063	120 x 120 cm	Quadrat mit Anti-Rutsch	transparent	1 Stück
122062	150 x 150 cm	Quadrat	transparent	1 Stück



## Antistatik Bodenschutzmatten

schützen vor statischer Aufladung und wehren Staub ab, **Unterseite ohne Ankerknoppen** – speziell für harte Böden

122043	120 x 150 cm	Rechteck	transparent	1 Stück
122044	120 x 90 cm	Rechteck mit Lippe	transparent	1 Stück
122045	115 x 134 cm	Rechteck mit Lippe	transparent	1 Stück



## Motivmatten

sorgen für Abwechslung auf einfarbigen Fußböden, **Unterseite ohne Ankerknoppen** – speziell für harte Böden



	90 x 120 cm	Rechteck		
122098-1	Kieselsteine			1 Stück
122098-2	Wassertropfen			1 Stück
122098-3	Riffelblech			1 Stück

# Bodenschutzmatten für Teppichböden

Art.-Nr. Artikel-Bezeichnung VE



## Bodenschutzmatten

**Unterseite mit Ankerknoppen** – speziell für nieder- bis mittelflorige Teppichböden bis 12 mm Höhe. Ankerknoppen bieten eine hohe Standfestigkeit, ohne den Teppich zu beschädigen.

Transparente Bodenschutzmatten aus hochwertigem Polycarbonat

122050	119 x 89 cm	Rechteck mit Lippe	transparent	1 Stück
122051	120 x 134 cm	Rechteck mit Lippe	transparent	1 Stück
122052	99 x 125 cm	Kontur	transparent	1 Stück
122054	119 x 75 cm	Rechteck	transparent	1 Stück
122088	119 x 89 cm	Rechteck	transparent	1 Stück
122089	120 x 100 cm	Rechteck	transparent	1 Stück
122056	120 x 134 cm	Rechteck	transparent	1 Stück
122091	120 x 150 cm	Rechteck	transparent	1 Stück
122058	120 x 183 cm	Rechteck	transparent	1 Stück
122093	120 x 200 cm	Rechteck	transparent	1 Stück
122090	120 x 120 cm	Quadrat	transparent	1 Stück

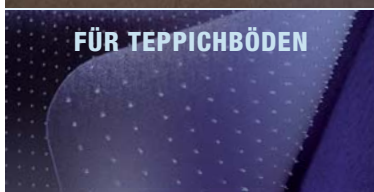

Schwarze Bodenschutzmatten aus phthalatfreiem Vinyl, für Teppichböden bis 6 mm Höhe

122065	78 x 118 cm	Rechteck	 schwarz	1 Stück
122066	90 x 120 cm	Rechteck	 schwarz	1 Stück
122067	120 x 150 cm	Rechteck	 schwarz	1 Stück

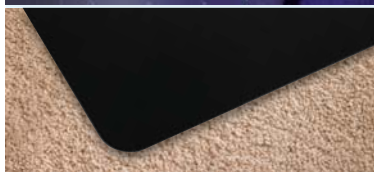

## Antistatik Bodenschutzmatten



schützen vor statischer Aufladung und wehren Staub ab, ohne dass ein Erdungskabel benötigt wird. **Unterseite mit Ankerknoppen** – speziell für Teppiche und Teppichböden bis 6 mm Höhe

122040	120 x 150 cm	Rechteck	transparent	1 Stück
122041	120 x 90 cm	Rechteck mit Lippe	transparent	1 Stück
122042	115 x 134 cm	Rechteck mit Lippe	transparent	1 Stück



**Mengenrabatt**  
Bodenschutzmatten  
ab 5 Stück  
**10%**



Rechteck



Rechteck m. Lippe



Quadrat



Kontur



Trapez



Rund



Halbkreis

# Treppenstufenmatten



## Treppenstufenmatten

Schützt Holztreppen vor Schäden und Abnutzungsspuren, aus transparentem, belastbarem Makrolon®, strukturierte Oberfläche, mit zusätzlichen Klebepunkten auf der Unterseite für ein erstes Fixieren.

122061	60 x 26 cm	Halbkreis	transparent	10 Stück
122068	56 x 17 cm	Halbkreis	transparent	10 Stück
122069	80 x 26 cm	Rechteck	transparent	10 Stück

# Anti-Ermüdungsmatten

**Mengenrabatt**  
Anti-Ermüdungsmatten  
122327 + 122328  
ab 3 Stück  
**10%**



## Anti-Ermüdungsmatten

Gummimatten mit speziellen Profilen schonen die Gelenke bei langem Stehen. Ideal zur Vorbeugung von Bein- und Rückenschmerzen. Zusätzlich sorgen sie für einen sicheren, rutschfesten Stand und schützen vor ungesunder Bodenwärme.

122327	71 x 78 cm	Riffel-Oberfläche	schwarz	1 Stück
122328	61 x 91 cm	Noppen-Oberfläche	schwarz	1 Stück
122331	86 x 143 cm	Spezialnoppen	schwarz	1 Stück
122332	85 x 300 cm	Spezialnoppen	schwarz	1 Stück
122333	115 x 175 cm	Spezialnoppen	schwarz	1 Stück

**Mengenrabatt**  
Anti-Ermüdungsmatten  
mit Spezialnoppen  
ab 10 Stück  
**10%**



# Türstopper



Art.-Nr. Artikel-Bezeichnung VE

**Türstopper** – Pilzform, Aluminium eloxiert, für schwere Türen, mit Dübel und Schraube  
40 mm Ø, 17 mm hoch

130690 AV	F 1 silber		1 Stück
130691	F 2 neusilber		1 Stück
130692 AV	F 3 gold		1 Stück
130693 AV	F 4 braun		1 Stück
130688 AV	Messing poliert		1 Stück
130689	Edelstahl-matt, rostfrei		1 Stück



**Türstopper** – Pilzform, Aluminium eloxiert, für schwere Türen, mit Dübel und Schraube  
60 mm Ø, 25 mm hoch

130740	F 1 silber		1 Stück
130741	Edelstahl-matt, rostfrei		1 Stück
130745 AV	Distanzscheibe zum Höhenausgleich um jeweils 15 mm		1 Stück



**Türstopper** – Messing, mit Gummiring  
28 mm Ø, 35 mm hoch

130721 AV	vernickelt		1 Stück
-----------	------------	-----------------------------------------------------------------------------------	---------



**Türstopper** – Messing, mit Gummiring  
30 mm Ø, 40 mm hoch

130750 AV	Messing poliert, lackiert		1 Stück
130751 AV	Messing verchromt, lackiert		1 Stück
130760	edelstahl-matt, lackiert		1 Stück



130764	edelstahl-matt, für Parkett ab 7,5 mm Stärke Schädigt nicht den Estrich, daher für Fußbodenheizung geeignet. Befestigung auch mit Montagedübel und Schraube möglich.		1 Stück
--------	-------------------------------------------------------------------------------------------------------------------------------------------------------------------------------	-------------------------------------------------------------------------------------	---------

**Türpuffer, Messing massiv**  
40 mm Ø

130686 AV	Messing poliert		1 Stück
130687	Messing verchromt		1 Stück

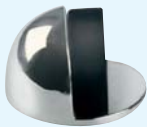

Mengenrabatt: ab 10 Stück 10%

**Türpuffer »Halbrund«**

keine Montage nötig, hält durch hohes Eigengewicht, rutschfest durch Gummi-Standfuß  
70 mm Ø, 80 mm hoch

130779	Edelstahl		1 Stück
--------	-----------	-------------------------------------------------------------------------------------	---------

Mengenrabatt: ab 10 Stück 10%



**Türpuffer »PUCK«**

keine Montage nötig, hält durch hohes Eigengewicht, rutschfest durch Gummi-Standfuß  
105 mm Ø, 45 mm hoch

130775	Edelstahl		1 Stück
--------	-----------	-------------------------------------------------------------------------------------	---------

Mengenrabatt: ab 10 Stück 10%



Art.-Nr. Artikel-Bezeichnung VE



## Fitschenringe

Art.-Nr.	Artikel-Bezeichnung	VE
<b>vermessingt</b>		
130670	11 mm Innen-Ø	100 Stück
130671	13 mm Innen-Ø	100 Stück
130672	16 mm Innen-Ø	100 Stück
<b>verzinkt</b>		
130670-1	11 mm Innen-Ø	100 Stück
130671-1	13 mm Innen-Ø	100 Stück
130672-1	16 mm Innen-Ø	100 Stück



## Türpuffer

25 mm Ø, 29 mm hoch

Art.-Nr.	Artikel-Bezeichnung	VE
130664	Sortiment, farblich sortiert	50 Stück
130664-1	schwarz	25 Stück
130664-2	grau	25 Stück
130664-3	braun	25 Stück
130664-4	beige	25 Stück
130664-6	weiß	25 Stück



## Kugeltürpuffer

34 mm Ø, mit Schrauben und Dübel

Art.-Nr.	Artikel-Bezeichnung	VE
130676-1	grau	10 Stück
130676-2	weiß	10 Stück
130676-3	beige	10 Stück
130676-4	schwarz	10 Stück
130676-5	braun	10 Stück

## Türstopper für Boden und Wand

35 mm Ø, 45 mm hoch, Metall »Top-Design«

Art.-Nr.	Artikel-Bezeichnung	VE
130661	nickel-matt	1 Stück

## Türpuffer - Kunststoff flach, elastisch,

selbstklebend und durchschraubbar, für Wände, Möbel oder Böden



Art.-Nr.	Artikel-Bezeichnung	VE
130694	weiß	25 Stück
130695 AV	beige	25 Stück



Art.-Nr.	Artikel-Bezeichnung	VE
130697	weiß	25 Stück



130 679



130677/678

## Türfeststeller

Art.-Nr.	Artikel-Bezeichnung	VE
130679 AV	Druckguss gold	Höhe 130 mm   Hub 22 mm 1 Stück
130677	silber einbrennlackiert	Höhe 215 mm   Hub 30 mm 1 Stück
130678	silber einbrennlackiert	Höhe 215 mm   Hub 50 mm 1 Stück



## Stoppit

Türstopper und Fensterkeil, 130 x 45 mm

Aus ungiftigem Silikon, haftet durch seine weiche Beschaffenheit sehr gut auf allen Böden und Oberflächen.

Art.-Nr.	Artikel-Bezeichnung	VE
130777-0100	schwarz	1 Stück
130777-0131	terracotta	1 Stück
130777-0180	braun	1 Stück
130777-0181	beige	1 Stück
130777-0190	weiß	1 Stück



# Möbelgleiter + Möbelstopper

Art.-Nr. Artikel-Bezeichnung VE

## Stuhlbeinnägel Eisen vernickelt



224515	15 mm Ø			100 Stück
224518	18 mm Ø			100 Stück
224520	20 mm Ø			100 Stück
224523	23 mm Ø			100 Stück
224525	25 mm Ø			100 Stück
224528	28 mm Ø			100 Stück
224530	30 mm Ø			100 Stück
224535	35 mm Ø			100 Stück

## Möbelgleiter mit Kunststoffeinlage



224718	18 mm Ø			100 Stück
224720	20 mm Ø			100 Stück
224722	22 mm Ø			100 Stück
224725	25 mm Ø			100 Stück
224730	30 mm Ø			100 Stück

## Stuhlbeinnägel Kunststoff, mit Eisenstift

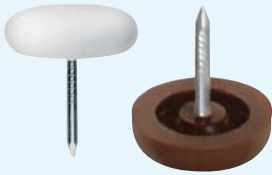

224620	20 mm Ø	weiß		100 Stück
224625	25 mm Ø	weiß		100 Stück
224630	30 mm Ø	weiß		100 Stück
224621	20 mm Ø	braun		100 Stück
224626	25 mm Ø	braun		100 Stück
224631	30 mm Ø	braun		100 Stück

## Stuhlbeinnägel Kunststoff, mit weichem Kunststoffpolster und Eisenstift



224640	20 mm Ø	weiß		100 Stück
224642	25 mm Ø	weiß		100 Stück
224643	30 mm Ø	weiß		100 Stück
224660	20 mm Ø	braun		100 Stück
224662	25 mm Ø	braun		100 Stück
224663	30 mm Ø	braun		100 Stück

## Nadelfilz-Bodenschoner Kunststoff, mit Metallstift und hochwertiger Nadelfilzscheibe (naturfarbig)

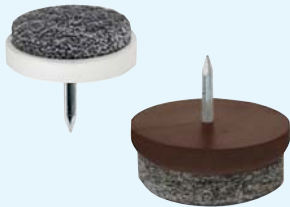

224819	17 mm Ø	weiß		100 Stück
224820	20 mm Ø	weiß		100 Stück
224824	24 mm Ø	weiß		100 Stück
224830	28 mm Ø	weiß		100 Stück
224833	17 mm Ø	braun		100 Stück
224831	20 mm Ø	braun		100 Stück
224834	24 mm Ø	braun		100 Stück
224835	28 mm Ø	braun		100 Stück

## Nadelfilz-Bodenschoner mit Schraube



224850	20 mm Ø	Kunststoff weiß		100 Stück
224851	24 mm Ø	Kunststoff weiß		100 Stück
224852	28 mm Ø	Kunststoff weiß		100 Stück
224860	20 mm Ø	Kunststoff braun		100 Stück
224861	24 mm Ø	Kunststoff braun		100 Stück
224862	28 mm Ø	Kunststoff braun		100 Stück
224837	20 mm Ø	Eisen vernickelt		100 Stück
224838	24 mm Ø	Eisen vernickelt		100 Stück
224839	28 mm Ø	Eisen vernickelt		100 Stück

## Möbelstopper mit Schraube, rutschfeste Ausführung durch Weich-Kunststoff



STOPPER

224622	24 mm Ø	weiß		100 Stück
224627	28 mm Ø	weiß		100 Stück
224623	24 mm Ø	braun		100 Stück
224628	28 mm Ø	braun		100 Stück
224624	24 mm Ø	schwarz		100 Stück
224629	28 mm Ø	schwarz		100 Stück

## Anti-Rutsch Gummi, selbstklebend



224750	22 mm Ø		10 SB-Beutel à 12 Stück
224751	28 mm Ø		10 SB-Beutel à 8 Stück
224752	22 x 22 mm		10 SB-Beutel à 12 Stück

Art.-Nr. Artikel-Bezeichnung VE

## Spezial-Möbelgleiter mit PTFE-/Teflonbeschichtung

Verringern Reibungswiderstand und Schiebegeräusche auf glatten Bodenbelägen, wie Laminat, Parkett, Marmor und glasierten Fliesen im Vergleich zu Filzleitern. Bitte beachten Sie, dass Teflonleiter demgegenüber einem erhöhten Verschleiß unterliegen.



225919	19 mm Ø, mit Nagel		blau	100 Stück
225925	25 mm Ø, mit Nagel		blau	100 Stück
225930	30 mm Ø, mit Nagel		blau	100 Stück
224922	22 mm Ø, mit Nagel und Clip		blau	25 Stück 100 Stück
224930	30 mm Ø, mit Nagel und Clip		blau	25 Stück 100 Stück
224941	22 mm Ø, mit Schraube		blau	1 Stück 100 Stück
224950	50 mm Ø, mit Schraube		braun	25 Stück 100 Stück

## Stuhlbein-Filze, selbstklebend



224810	17 mm Ø	weiß		10 SB-Beutel à 20 Stück
224840	22 mm Ø	weiß		10 SB-Beutel à 16 Stück
224870	28 mm Ø	weiß		10 SB-Beutel à 8 Stück
224880	35 mm Ø	weiß		10 SB-Beutel à 4 Stück
224890	25 x 30 mm	weiß		10 SB-Beutel à 8 Stück
224894	100 x 100 mm	weiß		1 SB-Beutel à 1 Stück
224892	100 x 200 mm	weiß		1 SB-Beutel à 1 Stück



224811	17 mm Ø	braun		10 SB-Beutel à 20 Stück
224841	22 mm Ø	braun		10 SB-Beutel à 16 Stück
224871	28 mm Ø	braun		10 SB-Beutel à 8 Stück
224881	35 mm Ø	braun		10 SB-Beutel à 4 Stück
224891	25 x 30 mm	braun		10 SB-Beutel à 8 Stück
224895	100 x 100 mm	braun		1 SB-Beutel à 1 Stück
224893	100 x 200 mm	braun		1 SB-Beutel à 1 Stück

## Filzstanzteile auf Rolle, selbstklebend



224817	17 mm Ø x 3 mm	weiß		1.000 Stück, 1 Rolle
224822	22 mm Ø x 3 mm	weiß		1.000 Stück, 1 Rolle
224828	28 mm Ø x 3 mm	weiß		1.000 Stück, 1 Rolle
224832	35 mm Ø x 3 mm	weiß		1.000 Stück, 1 Rolle
224843	50 mm Ø x 3 mm	weiß		1.000 Stück, 1 Rolle
224847	17 mm Ø x 3 mm	braun		1.000 Stück, 1 Rolle
224842	22 mm Ø x 3 mm	braun		1.000 Stück, 1 Rolle
224848	42 mm Ø x 3 mm	braun		1.000 Stück, 1 Rolle
224849	50 mm Ø x 3 mm	braun		1.000 Stück, 1 Rolle

## Möbeluntersetzer

transparent, Polystyrol, schlagfest

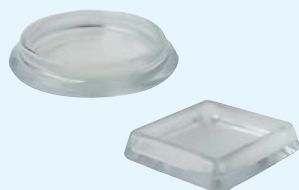

224745	Innen-Ø 33 mm	rund		25 Stück
224755	Innen-Ø 40 mm	rund		25 Stück
224765	Innen-Ø 50 mm	rund		25 Stück
224845	Innen 40 x 40 mm	eckig		25 Stück

## Kunststoff-Gleiter mit Zapfen (Ø 13 mm), schwarz



224299	Bauhöhe 16 mm, Ø 46 mm		4 Stück
224300	Bauhöhe 25 mm, Ø 46 mm		4 Stück
224301	Bauhöhe 35 mm, Ø 50 mm		4 Stück
224302	Bauhöhe 50 mm, Ø 55 mm		4 Stück

## Kunststoff-Gleiter mit Schraubloch schwarz



224304	Bauhöhe 16 mm, Ø 46 mm		4 Stück
224305	Bauhöhe 25 mm, Ø 46 mm		4 Stück
224306	Bauhöhe 35 mm, Ø 50 mm		4 Stück
224307	Bauhöhe 50 mm, Ø 50 mm		4 Stück
224298	Höhenausgleichscheiben Ø 50 x 10 mm, 3 mm hoch		250 Stück

## Kunststoff-Gleiter schwarz

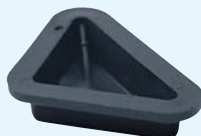

224315 AV	Bauhöhe 15 mm		4 Stück
224316 AV	Bauhöhe 25 mm		4 Stück
224317 AV	Bauhöhe 35 mm		4 Stück



# MöbelfüÙe

Art.-Nr.	Artikel-Bezeichnung	VE
<b>MöbelfüÙe</b> verchromt, Fußplatte 65 mm Ø		
224401	mit Anschraubplatte 38 x 38 mm, Bauhöhe 80 mm	4 Stück
224400	mit Steckbefestigung 9 mm Ø + Hülse, Bauhöhe 74 mm	4 Stück
<b>MöbelfüÙe mit Filz</b> verchromt, Fußplatte Polyamid schwarz 60 mm Ø		
224403	mit Anschraubplatte 38 x 38 mm, Bauhöhe 75 mm	4 Stück
224402	mit Steckbefestigung 9 mm Ø + Hülse, Bauhöhe 69 mm	4 Stück
<b>MöbelfüÙe</b> verchromt, 42 mm Ø		
224404	mit M8 Gewindestift, Bauhöhe 100 mm	4 Stück

# Bürostuhlrollen

<b>Bürostuhlrolle 50 mm Ø gebremst</b> Tragfähigkeit pro Rolle 50 kg, Bauhöhe 60 mm Befestigung mit Einschlagstift (10 mm Ø), <b>bitte separat bestellen</b>		
224552	Kunststoffgehäuse schwarz <b>weiche Lauffläche für harte Böden</b>	5 Stück
224557	Zinkdruckgehäuse verchromt <b>harte Lauffläche für weiche Böden</b>	5 Stück
<b>Einschlagstift</b> für Bürostuhlrollen mit Aufnahme Ø 10 mm		
224560	Ø 10 x 21,0 mm	5 Stück
224561	Ø 11 x 22,0 mm	5 Stück
224562	Ø 11 x 19,5 mm	5 Stück

# Möbelrollen

<b>Walzenrolle 25 mm Ø</b> Kunststoffgehäuse schwarz Tragfähigkeit pro Rolle <b>75 kg</b> , Bauhöhe 47 mm		
224555	mit Anschraubplatte 38 x 38 mm <b>harte Lauffläche für weiche Böden</b>	4 Stück
224553	<b>weiche Lauffläche für harte Böden</b>	4 Stück
<b>Walzenrolle mit 2 Rädern 25 mm Ø</b> Kunststoffgehäuse schwarz Tragfähigkeit pro Rolle <b>90 kg</b> , Bauhöhe 47 mm		
224556	mit Anschraubplatte 38 x 38 mm <b>harte Lauffläche für weiche Böden</b>	4 Stück
224554	<b>weiche Lauffläche für harte Böden</b>	4 Stück

Art.-Nr. Artikel-Bezeichnung VE



### Möbel-Kugelrolle

Zinkdruckguss hochglanz-verchromt,  
Tragfähigkeit pro Rolle 50 mm Ø = 50 kg / Rolle 63 mm Ø = 65 kg

224050	mit Anschraubplatte 40 x 40 mm Rolle ca. 50 mm Ø – Bauhöhe 66 mm	4 Stück
224060	Rolle ca. 63 mm Ø – Bauhöhe 80 mm	4 Stück



### Möbel-Doppellenkrolle 50 mm Ø

Gehäuse Zinkdruckguss verchromt,  
Rad Kunststoff schwarz,  
Tragfähigkeit pro Rolle 50 kg

224326	mit Anschraubplatte 38 x 38 mm, Bauhöhe 64 mm <b>weiche Lauffläche für harte Böden</b>	4 Stück
224327	mit Steckbefestigung 9 mm Ø + Hülse, Bauhöhe 58 mm <b>weiche Lauffläche für harte Böden</b>	4 Stück



### Gummi-Lenkrolle 50 mm Ø

Gehäuse Stahl verchromt,  
Gummirad grau,  
Tragfähigkeit pro Rolle 30 kg

224048	mit Anschraubplatte 47 x 47 mm, Bauhöhe 71 mm <b>weiche Lauffläche für harte Böden</b>	4 Stück
--------	-------------------------------------------------------------------------------------------	---------



### Doppellenkrolle 50 mm Ø

Rad und Gehäuse Kunststoff schwarz,  
Tragfähigkeit pro Rolle 50 kg

224250	mit Anschraubplatte 38 x 38 mm, Bauhöhe 62 mm <b>harte Lauffläche für weiche Böden</b>	4 Stück
224650	<b>weiche Lauffläche für harte Böden</b>	4 Stück
224350	mit Steckbefestigung 9 mm Ø + Hülse, Bauhöhe 56 mm <b>harte Lauffläche für weiche Böden</b>	4 Stück
224550	<b>weiche Lauffläche für harte Böden</b>	4 Stück
224450	mit Gewindestift M8 x 15 mm, Bauhöhe 64 mm <b>harte Lauffläche für weiche Böden</b>	4 Stück



### Doppellenkrolle 37 mm Ø

Gehäuse Zinkdruckguss, verchromt,  
Rad Kunststoff schwarz, breite Lauffläche, niedrige Bauhöhe,  
Tragfähigkeit pro Rolle 40 kg

224037	mit Anschraubplatte 38 x 38 mm, Bauhöhe 44 mm <b>harte Lauffläche für weiche Böden</b>	4 Stück
224047	<b>weiche Lauffläche für harte Böden</b>	4 Stück
224137	mit Steckbefestigung 9 mm Ø + Hülse, Bauhöhe 40 mm <b>harte Lauffläche für weiche Böden</b>	4 Stück
224147	<b>weiche Lauffläche für harte Böden</b>	4 Stück



### Stil-Möbellenkrolle 32 mm Ø

Messing massiv, mit Abdeckkappe, Steckbefestigung + Hülse, Bauhöhe 65 mm

224155	messing glanz	4 Stück
224157	nickel matt	4 Stück

# Treppenläuferstangen

Art.-Nr. Artikel-Bezeichnung VE

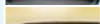

**Messing-Rohr 9 mm Ø**  
rund  
Reinmessing, Längen à 5 m

119010	vernickelt		1 Länge
119020	gelb, lackiert		1 Länge

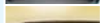

**ME-Rohr 11 mm Ø**  
rund  
Eisenrohr mit Messingüberzug, Längen à 5 m

119011	vernickelt		1 Länge
119021	gelb, lackiert		1 Länge

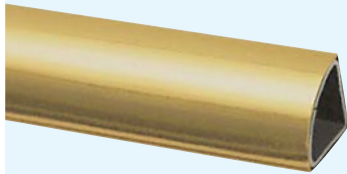

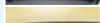

**ME-Rohr dreikant**  
16 x 16 mm  
Eisenrohr mit Messingüberzug, Längen à 5 m

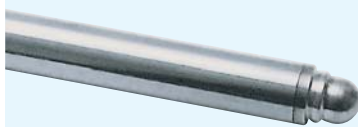
119131	vernickelt		1 Länge
119130	gelb, lackiert		1 Länge



**Treppenläuferstangen 9 mm Ø, massiv, mit Endknöpfen**

119129	vernickelt		10 Stück
119132	70 cm		10 Stück
119133	75 cm		10 Stück
119134	80 cm		10 Stück

119141	gelb, lackiert		10 Stück
119142	70 cm		10 Stück
119143	75 cm		10 Stück
119144	80 cm		10 Stück



**Treppenläuferstangen 9 mm Ø, hohl, mit Endknöpfen**  
Eisenrohr mit Messingüberzug

119110	vernickelt		10 Stück
119111	75 cm		10 Stück

119120	gelb, lackiert		10 Stück
119121	75 cm		10 Stück



**Treppenläuferstangen 11 mm Ø, hohl, mit Endknöpfen**  
Eisenrohr mit Messingüberzug

119112	vernickelt		10 Stück
119113	75 cm		10 Stück
119114	80 cm		10 Stück

119122	gelb, lackiert		10 Stück
119123	75 cm		10 Stück
119124	80 cm		10 Stück

Weitere Größen auf Anfrage!

Art.-Nr. Artikel-Bezeichnung VE

## Treppenstangenösen

	120010	Messing, vernickelt für 9 mm Stangen Ø		100 Stück
	120011	für 11 mm Stangen Ø		100 Stück
	120020	Messing, gelb für 9 mm Stangen Ø		100 Stück
	120021	für 11 mm Stangen Ø		100 Stück

## Schraubendreher für Treppenstangenösen

	310801	233 mm lang, verchromt		1 Stück
--	--------	------------------------	--	---------

## Klappösen

	120110	Messing, vernickelt für 9 mm Stangen Ø		10 Paar
	120111	für 11 mm Stangen Ø		10 Paar
	120120	Messing, gelb für 9 mm Stangen Ø		10 Paar
	120121	für 11 mm Stangen Ø		10 Paar

## Klappösen seitlich geschlossen

	120210	Messing, vernickelt für 9 mm Stangen Ø		10 Paar
	120211	für 11 mm Stangen Ø		10 Paar
	120220	Messing, gelb für 9 mm Stangen Ø		10 Paar
	120221	für 11 mm Stangen Ø		10 Paar

## Klappösen seitlich geschlossen

Für Dreikant-Stangen 16 x 16 mm

	120223	Messing, vernickelt		20 Paar
	120222	Messing, gelb		20 Paar

## Schrauben für Klappösen 3,0 x 30 mm

	kü108423	Eisen verzinkt		DIN 97 Seko	20 Stück
	kü108030	Messing, gelb		DIN 95 Liko	20 Stück

## Endknöpfe

	120410	Messing, vernickelt für 9 mm Stangen Ø		100 Stück
	120411	für 11 mm Stangen Ø		100 Stück
	120420	Messing, gelb für 9 mm Stangen Ø		100 Stück
	120421	für 11 mm Stangen Ø		100 Stück

## Teppichnägel

	120510	vernickelt 30 mm lang		100 Stück
	120511	50 mm lang		100 Stück
	120520	gelb 30 mm lang		100 Stück
	120522	50 mm lang		100 Stück

## Buchsen, Nylon (ohne Teppichnägel)

für Teppichnägel

	120530	8 x 15 mm		100 Stück
--	--------	-----------	--	-----------



Art.-Nr.

Artikel-Bezeichnung

VE

## Treppenläuferstangen 10 mm Ø

massiv, rund

**Edelstahl, gebürstet**

Art.-Nr.	Artikel-Bezeichnung	VE
119150	70 cm	10 Stück
119151	80 cm	10 Stück
119152	90 cm	10 Stück
119153	100 cm	10 Stück

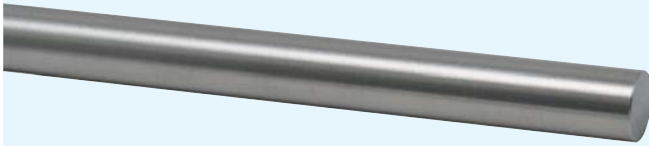

## Treppenläuferstangen 10 mm Ø

massiv, rund

**Edelstahl, poliert**

Art.-Nr.	Artikel-Bezeichnung	VE
119156	70 cm	10 Stück
119157	80 cm	10 Stück
119158	90 cm	10 Stück
119159	100 cm	10 Stück

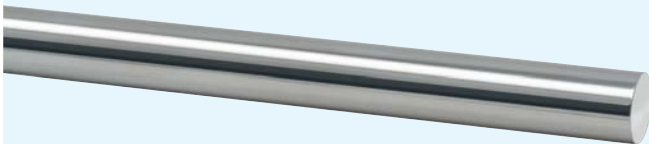

## Treppenläuferstangen mit Endstücken 10 mm Ø

massiv, rund

**Edelstahl, gebürstet**

Art.-Nr.	Artikel-Bezeichnung	VE
119160	70 cm	10 Stück
119161	80 cm	10 Stück
119162	90 cm	10 Stück
119163	100 cm	10 Stück



## Treppenläuferstangen mit Endstücken 10 mm Ø

massiv, rund

**Edelstahl, poliert**

Art.-Nr.	Artikel-Bezeichnung	VE
119166	70 cm	10 Stück
119167	80 cm	10 Stück
119168	90 cm	10 Stück
119169	100 cm	10 Stück

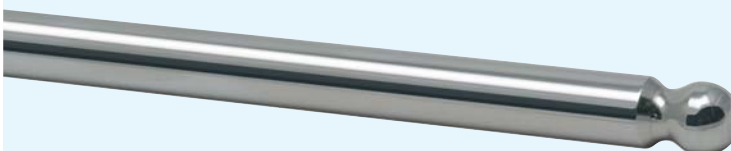

Weitere Größen auf Anfrage!

Art.-Nr. Artikel-Bezeichnung VE

## Treppenstangenösen seitlich geschlossen Edelstahl

für 10 mm Stangen Ø,  
Höhe: 22 mmm, Ø: 16 mm, Bohrung: ca. 10 mm tief



119170  
119171

Edelstahl gebürstet  
Edelstahl poliert



10 Stück  
10 Stück



Mit Seko-Schraube zur Befestigung (verzinkt, 3 x 35 mm)



130867 **Edelstahl-Schrauben**, Seko, PZ, 3 x 35 mm

200 Stück

## Treppenstangenösen seitlich offen Edelstahl

für 10 mm Stangen Ø,  
Höhe: 22 mmm, Ø: 16 mm



119172  
119173

Edelstahl gebürstet  
Edelstahl poliert



10 Stück  
10 Stück



Mit Seko-Schraube zur Befestigung (verzinkt, 3 x 35 mm)

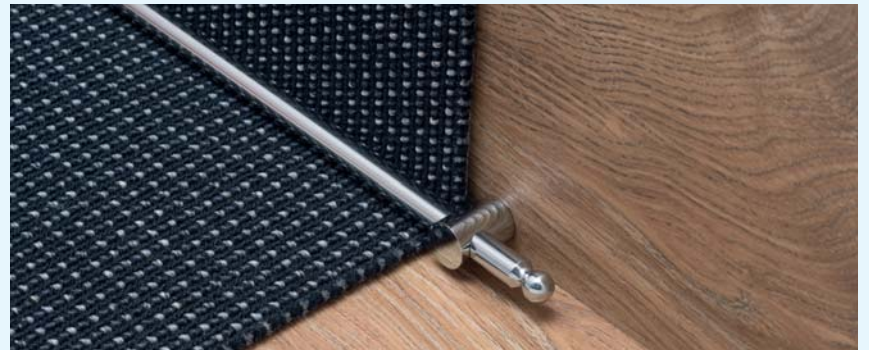

130867 **Edelstahl-Schrauben**, Seko, PZ, 3 x 35 mm

200 Stück

## Treppenstangenösen Messing

für 10 mm Stangen Ø



119174  
119175

nickel matt  
nickel poliert



100 Stück  
100 Stück

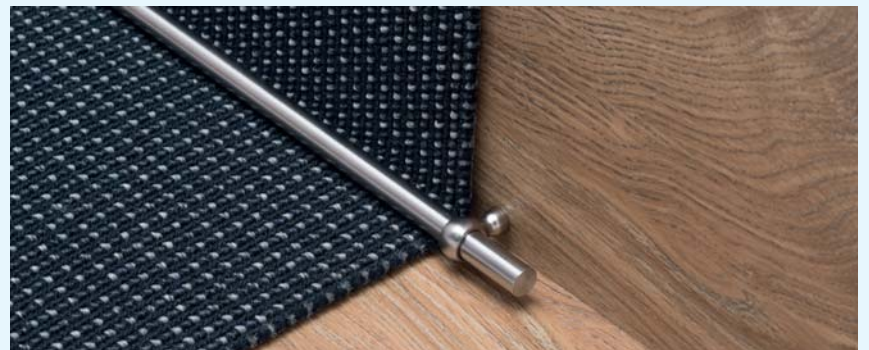

310801

## Schraubendreher für Treppenstangenösen

233 mm lang, verchromt

1 Stück

Art.-Nr. Artikel-Bezeichnung VE

## ED - Quadro-Dübel, Kunststoff

Die optimale Quadro-Spreizung garantiert einen festen Halt.



117090	gelb	5mm Ø	für Schrauben-Ø	2,5 – 3,5 mm	500 St. 1.000 St.	
117091	rot	6mm Ø	für Schrauben-Ø	4,0 – 5,0 mm	250 St. 1.000 St.	
117092	braun	8mm Ø	für Schrauben-Ø	4,5 – 6,0 mm	250 St. 1.000 St.	
117093	blau	10mm Ø	für Schrauben-Ø	6,0 – 8,0 mm	100 St.	
117094	grün	12mm Ø	für Schrauben-Ø	8,0 – 10,0 mm	100 St.	
117095	grau	14mm Ø	für Schrauben-Ø	10,0 – 12,0 mm	50 St.	
117090-1	gelb	5mm Ø, lose geschüttet			2.500 St.	
117091-1	rot	6mm Ø, lose geschüttet			2.500 St.	
117092-1	braun	8mm Ø, lose geschüttet			2.000 St.	



## Nylondübel S (Fischer)



117000	4 mm Ø	für Schrauben-Ø	2,0 – 3,0 mm	200 St.	
117001	5 mm Ø	für Schrauben-Ø	2,5 – 4,0 mm	100 St.	
117002	6 mm Ø	für Schrauben-Ø	3,5 – 5,0 mm	100 St.	
117003	8 mm Ø	für Schrauben-Ø	4,5 – 6,0 mm	100 St.	
117004	10 mm Ø	für Schrauben-Ø	6,0 – 8,0 mm	50 St.	
117005	12 mm Ø	für Schrauben-Ø	8,0 – 10,0 mm	25 St.	

## Nylondübel SX (Fischer)



117007	5 x 25 mm	für Schrauben-Ø	2,5 – 4,0 mm	100 St.		
117008	6 x 30 mm	für Schrauben-Ø	3,5 – 5,0 mm	100 St.		
117009	8 x 40 mm	für Schrauben-Ø	4,5 – 6,0 mm	100 St.		
117010	6 x 50 mm	extra lang, ohne Rand	für Schrauben-Ø	3,5 – 5,0 mm	100 St.	
117011	8 x 65 mm	extra lang, ohne Rand	für Schrauben-Ø	4,5 – 6,0 mm	50 St.	

## Parallel-Spreizdübel PSD (Tox)

117036	6 x 70 mm	für Schrauben-Ø	4,5 – 5,0 mm	50 St.	
117037	8 x 90 mm	für Schrauben-Ø	5,0 – 6,0 mm	50 St.	

Speziell für Leichthochlochziegel



## TRIKA - KAPPENDÜBEL (Tox)

117020	5 mm Ø	für Schrauben-Ø	3,0 – 4,0 mm	100 St.	
117021	6 mm Ø	für Schrauben-Ø	4,0 – 5,0 mm	100 St.	
117022	8 mm Ø	für Schrauben-Ø	6,0 – 7,0 mm	100 St.	



Art.-Nr. Artikel-Bezeichnung VE



## Allzweckdübel DEKO (Tox)

- Dübelkappe verhindert ein Tieferrutschen ins Bohrloch und schützt die Oberfläche
- 4-fach geteilter Spreizkörper mit Dübelkappe für gleichmäßige Kraftverteilung
- Hält in fast allen Baustoffen
- Sichere Verknötung
- Drehsicherungen verhindern das Mitdrehen im Bohrloch



117112	5 x 25 mm	für Schrauben-Ø 3,0 – 4,0 mm	100 St.
117113	6 x 28 mm	für Schrauben-Ø 3,5 – 5,0 mm	100 St.
117114	6 x 41 mm	für Schrauben-Ø 3,5 – 5,0 mm	100 St.
117115	8 x 49 mm	für Schrauben-Ø 4,0 – 6,0 mm	100 St.
117116	10 x 66 mm	für Schrauben-Ø 6,0 – 8,0 mm	100 St.

## 2-K Allzweckdübel DUOPOWER (Fischer)

- Zwei Materialkomponenten für beste Lastwerte in Voll-, Loch und Plattenbaustoffen  
Der Dübel aktiviert je nach Baustoff das optimale Funktionsprinzip (Spreizen, Klappen) für den besten Halt
- Geeignet für Holz-, Spanplatten- und Stockschrauben  
Schraubenlänge = Dübellänge + Anbauteildicke + Schraubendurchmesser
- Bei Plattenbaustoffen darf der gewindelose Teil der Schraube nicht länger als die Anbauteildicke sein
- Drehsicherungen verhindern das Mitdrehen im Bohrloch



117013	5 x 25 mm	für Schrauben-Ø 3,0 – 4,0 mm	100 St.
117014	6 x 30 mm	für Schrauben-Ø 4,0 – 5,0 mm	100 St.
117015	8 x 40 mm	für Schrauben-Ø 4,5 – 6,0 mm	100 St.
117016	10 x 50 mm	für Schrauben-Ø 6,0 – 8,0 mm	50 St.

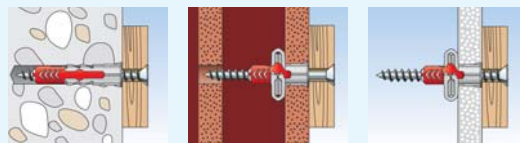

## Dübelement

mit 10 mm Spezialdübel, Sechskantschraube und Doppel-Gewindestück

Senkkopf-Torxschraube mit M5 Innengewinde.  
Verwendbar mit der M5 Sechskantschraube zur Befestigung von Raffhaltern und Stilgarnituren. Mit dem Doppel-Gewindestück M5 / M6 sind auch Schalrosetten, Abstandhalter, Seilgarnituren, Vorhanggarnituren usw. zu montieren.  
(Schraubbit TX 40 bitte extra bestellen)



117117	10 x 80 mm	12 Stück
117118	10 x 100 mm	12 Stück
117119	10 x 120 mm	12 Stück
117120	10 x 140 mm	12 Stück

326471	<b>TORX Bit-Einsatz TX40</b>	1 Stück
--------	------------------------------	---------

117107	<b>Doppel-Gewindestück M5/M6</b>	50 Stück
--------	----------------------------------	----------

117123	<b>Sechskantschraube M5x12mm</b>	50 Stück
--------	----------------------------------	----------



Art.-Nr. Artikel-Bezeichnung VE



## Universal-Hohlraumdübel

Geeignet für Beton, Vollsteine, Lochsteine, Hohlsteine, Gasbeton, Gipskarton und Plattenbaustoffe.  
Verbindung durch Spreizen und Knicken.  
Geeignet für Holz- und Spanplattenschrauben.

117053	6 x 45 mm	für Schrauben-Ø 3,0 – 3,5 mm	100 Stück
117054	8 x 50 mm	für Schrauben-Ø 4,0 – 5,0 mm	100 Stück



## Kippdübel

Oberflächenbündiger Nylon-Dübel für Hohlraummontagen, z.B. bei Jalousiekästen mit Styropordämmung.

117045	10 x 125 mm	für Schrauben-Ø 4,0 mm	25 Stück
--------	-------------	------------------------	----------

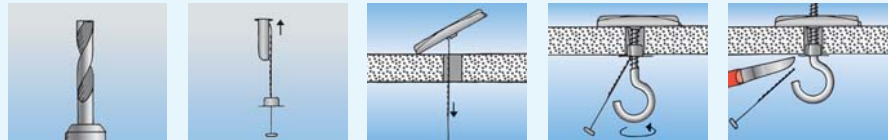

## Federklappdübel

Steilgewinde

117040	M 3 x 85 mm mit Rändelmutter		100 Stück
117042	Rändelmutter M 3		100 Stück
117044	M 3 x 60 mm mit Seko-Schraube		100 Stück



## Markisen-Montagesystem THERMO PROOF (Tox)

Zur Befestigung schwerer Gegenstände an Außenwänden mit Dämmschicht.

- Einfache und schnelle Montage
- AQUA-STOP Spezialdichtmittel schützt effektiv vor Wasserschäden
- Praktisch kein Energieverlust beim Wärmedämmverbundsystem
- Stufenlos justierbare Isolierhülse ISO-SPACER
- Für Dämmung bis 160 mm Dicke geeignet
- Rostfreie Edelstahlkomponenten verhindern unschöne Flecken auf dem Putz

117050	Montage-Set mit dem Inhalt:	1 Set
	2 x Gewindestangen M12 x 300 mm mit Muttern und Unterlegscheiben aus Edelstahl	
	2 x Isolierhülsen ISO-SPACER (Abstandshalter)	
	2 x Siebhülsen 15 x 130 mm	
	1 x Dichtmittel AQUA-STOP Silikon, Farbe: transparent, 80 ml	



## Verbundmörtel LIQUIX TVM-STV-K styrolfrei

Bestens geeignet für das Markisen-Montagesystem THERMO PROOF.

117077	Kartusche 280 ml	1 Stück
--------	------------------	---------



Art.-Nr. Artikel-Bezeichnung VE



## Hohlraum-Metalldübel

Spezial-Metalldübel mit Schraube für die Befestigung an Decken und Wänden wie Rigips, Hohlräumen usw.

Art.-Nr.	Schraube	Klemmdicke	VE
117100	M 4 x 32 mm	3 – 13 mm	100 Stück
117101	M 5 x 52 mm	5 – 21 mm	100 Stück
117102	M 6 x 52 mm	5 – 21 mm	100 Stück



100 Stück  
100 Stück  
100 Stück



## Senkkopf-Gewindeschraube

Kreuzschlitz, Eisen verzinkt

117130	M 4 x 40 mm	100 Stück
117131	M 5 x 50 mm	100 Stück
117132	M 6 x 50 mm	100 Stück



## Gewindestift

117104 AV	M 4 x 58 mm	50 Stück
117106 AV	M 5 x 42 mm	50 Stück
117103 AV	M 6 x 45 mm	50 Stück



117107	<b>Doppel-Gewindestück M5/M6</b>	50 Stück
--------	----------------------------------	----------

328660	<b>Montage-Zange</b>	1 Stück
--------	----------------------	---------

für Hohlraum-Metalldübel

## Hohlraum-Dübel-Sortiment

117110	Hohlraum-Dübel-Sortiment bestehend aus:	1 Set
--------	-----------------------------------------	-------

- 1 St. Montage-Zange
- 50 St. Metalldübel mit Schrauben M 4 x 40 mm
- 25 St. Metalldübel mit Schrauben M 5 x 50 mm
- 50 St. Metalldübel M 6
- 15 St. Schrauben M 6 x 50 mm
- 35 St. Gewindestifte M 6 x 50 mm

Komplett im Sortimentskoffer mit Einteilung

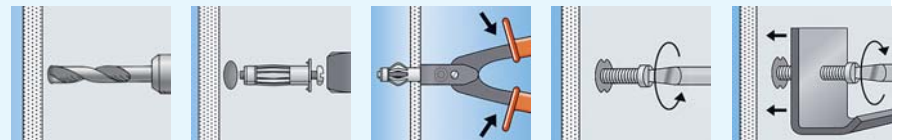

1. Bohren

2. Hohlraumdübel mit Schraube setzen

3. Mit Montagezange anziehen

4. Schraube ausdrehen

5. Bauteil fixieren

## Reparaturmasse

Universelle 2-Komponenten-Klebstoffmasse, schnellhärtend auf Epoxidharzbasis, nach 10 min. fest

117049	58 g	1 Stück
--------	------	---------



Art.-Nr. Artikel-Bezeichnung VE

## Gipskartondübel »Mini« mit Schraube

Kurze Dübellänge und nur 10 mm Kopfdurchmesser. Selbstbohrende Spitze und scharfes, selbstschneidendes Gewinde. Vorsteckmontage, Bit in gleicher Größe für Schraube und Dübel einsetzen, sitzt bündig und beschädigt nicht die Plattenoberfläche.





117067 Dübel 30 mm lang, Seko-Schraube 3,0 x 25 mm 200 Stück 

## Hohlraum-Dübel »Speed«

Nylon-Dübel für Gipskartonplatten, universell einsetzbar für unterschiedliche Schraubengrößen von 3,5 – 5,0 mm Ø, komplett mit Setzwerkzeug ¼"



117087 Dübel 25 mm lang 200 Stück 

310811 **Setzwerkzeug** für Speed-Dübel  1 Stück

## Rigipsdübel »FiberJet« elektrisch isolierend

Kunststoff-Dübel für Vorsteckmontage in Gipskartonplatten, für Schrauben von 3,5 – 4,5 mm Ø und M4 Gewinde, komplett mit Duo-Bit



117085 Dübel 32 mm lang 200 Stück 

326387 **Duo-Bit** für FiberJet-Dübel  1 Stück

## RIGIDRIVE Rigipsdübel, 31 mm kurz

selbstbohrender Schnellmontagedübel mit Schraube für Leichtbauwände, wie Gipskarton, Gasbeton und Gipsvollmaterial. Zur Montage von Innenlaufschienen, Jalousien, Raumteilern, Raffhaken, Fußleisten usw.



117061 **RIGIDRIVE**-Dübel mit Liko-Schrauben 35 mm für Befestigungsdicke 0 – 12 mm, komplett 100 Stück 

117062 **RIGIDRIVE**-Dübel mit Seko-Schrauben 50 mm für Befestigungsdicke 12 – 27 mm, komplett 100 Stück

117175 **RIGIDRIVE**-Montagedübel, 30 mm ohne Schrauben, Anwendung mit Holz-, Blech- und Spanplattenschrauben 4,0 – 4,5 mm Ø und M4 Gewinde 100 Stück  1.000 Stück

117170 **Gipskarton-Dübel**, 40 mm, selbstbohrend ohne Schrauben, mit Rückdrehsicherung, für Spanplattenschrauben 4,0 – 4,5 mm Ø und M4 Gewinde 100 Stück 1.000 Stück



116306 **Passende Schraube:** **Liko-Schraube** 4,5 x 35 mm  100 Stück

117064 **RIGIDRIVE** Dübelsortiment 1 Stück

- 200 RIGIDRIVE-Dübel
- 100 Liko-Schrauben
- 100 Seko-Schrauben
- 50 M6-Rigips-Dübel
- 1 Setzwerkzeug für M6 Rigips-Dübel
- 1 Schraubendreher
- 1 Bit-Box

Komplett im Sortimentskoffer mit Einteilung



Art.-Nr. Artikel-Bezeichnung VE



## Spezial-Spanplattenschrauben mit kleinem Kopf

Senkkopf mit Pozi-Kreuzschlitz, verzinkt, gehärtet, kunststoff-gleitbeschichtet  
Für Alu-Mini-Vorhangschienen usw.



\* Vollgewinde,  
gelb passiviert



Vollgewinde,  
original ABC SPAX,  
transparente  
Gleitbeschichtung

### Kleiner Kopf 5 mm Ø

116117	2,5 x 12 mm	Vollgewinde*	200 Stück
116118	2,5 x 16 mm	Vollgewinde*	200 Stück
116119	2,5 x 20 mm	Vollgewinde*	200 Stück

### Kleiner Kopf 6 mm Ø

116242	3,0 x 12 mm	Vollgewinde	200 Stück
116243	3,0 x 16 mm	Vollgewinde	200 Stück
116244	3,0 x 20 mm	Vollgewinde	200 Stück
116245	3,0 x 25 mm	Vollgewinde	200 Stück
116246	3,0 x 30 mm	Vollgewinde	200 Stück
116247	3,0 x 35 mm	Vollgewinde	200 Stück

116248-1	3,0 x 40 mm	Vollgewinde	200 Stück
----------	-------------	-------------	-----------



Auf der nächsten Seite!

## Spezial-Spanplattenschrauben-Sortiment Spanplattenschrauben-Sortiment

Art.-Nr. 116 251  
Art.-Nr. 116 250



## Spanplattenschrauben

(Mehrzweckschrauben), Senkkopf mit Pozi-Kreuzschlitz, verzinkt, gehärtet, kunststoff-gleitbeschichtet

116280	3,5 x 25 mm	Vollgewinde	200 Stück
116281	3,5 x 30 mm	Vollgewinde	200 Stück
116282	3,5 x 35 mm	Vollgewinde	200 Stück
116283-1	3,5 x 40 mm	Vollgewinde	200 Stück
116284-1	3,5 x 45 mm	Vollgewinde	200 Stück
116285-1	3,5 x 50 mm	Vollgewinde	200 Stück

116200	4,0 x 16 mm	Vollgewinde	200 Stück
116201	4,0 x 20 mm	Vollgewinde	200 Stück
116202	4,0 x 25 mm	Vollgewinde	200 Stück
116203	4,0 x 30 mm	Vollgewinde	200 Stück
116204	4,0 x 35 mm	Vollgewinde	200 Stück
116205	4,0 x 40 mm	Vollgewinde	200 Stück
116206	4,0 x 45 mm	Vollgewinde	200 Stück
116207	4,0 x 50 mm	Vollgewinde	200 Stück
116208	4,0 x 60 mm	Teilgewinde	200 Stück
116208-1	4,0 x 60 mm	Vollgewinde	200 Stück
116108	4,0 x 70 mm	Teilgewinde	100 Stück

116209	4,5 x 30 mm	Vollgewinde	200 Stück
116210	4,5 x 35 mm	Vollgewinde	200 Stück
116211	4,5 x 40 mm	Vollgewinde	200 Stück
116212	4,5 x 45 mm	Vollgewinde	200 Stück
116213	4,5 x 50 mm	Vollgewinde	200 Stück
116214	4,5 x 60 mm	Teilgewinde	200 Stück
116214-1	4,5 x 60 mm	Vollgewinde	100 Stück
116227	4,5 x 70 mm	Teilgewinde	100 Stück
116227-1	4,5 x 70 mm	Vollgewinde	100 Stück
116228	4,5 x 80 mm	Teilgewinde	100 Stück

116215	5,0 x 40 mm	Vollgewinde	200 Stück
116216	5,0 x 45 mm	Vollgewinde	200 Stück
116217	5,0 x 50 mm	Vollgewinde	200 Stück
116218 <sup>AV</sup>	5,0 x 55 mm	Vollgewinde	200 Stück
116219	5,0 x 60 mm	Teilgewinde	200 Stück
116220 <sup>AV</sup>	5,0 x 70 mm	Teilgewinde	100 Stück
116220-1	5,0 x 70 mm	Vollgewinde	100 Stück
116221 <sup>AV</sup>	5,0 x 80 mm	Teilgewinde	100 Stück
116221-1	5,0 x 80 mm	Vollgewinde	100 Stück
116222 <sup>AV</sup>	5,0 x 90 mm	Teilgewinde	100 Stück
116223 <sup>AV</sup>	5,0 x 100 mm	Teilgewinde	100 Stück

Teilgewinde,  
original ABC SPAX,  
transparente  
Gleitbeschichtung

Vollgewinde,  
original ABC SPAX,  
transparente  
Gleitbeschichtung

116224 <sup>AV</sup>	6,0 x 70 mm	Teilgewinde	100 Stück
----------------------	-------------	-------------	-----------

Art.-Nr. Artikel-Bezeichnung VE



## Spezial-Spanplattenschrauben-Sortiment mit **kleinem Kopf**

Senkkopf mit Pozi-Kreuzschlitz, verzinkt, gehärtet, gleitbeschichtet

116251 Inhalt: je 200 Stück 1 Stück



**Kleiner Kopf 5 mm Ø**  
2,5 x 16 mm  
2,5 x 20 mm

**Kleiner Kopf 6 mm Ø**  
3,0 x 12 mm  
3,0 x 16 mm  
3,0 x 20 mm  
3,0 x 25 mm  
3,0 x 30 mm  
3,0 x 35 mm  
3,0 x 40 mm



Komplett im Sortimentskoffer mit Einteilung



## Spanplattenschrauben-Sortiment

Mehrzweckschrauben aus hochwertigem Qualitätsstahl, gleitbeschichtet

116250 Inhalt: 1 Stück



200 Stück 4 x 20 mm  
200 Stück 4 x 25 mm  
200 Stück 4 x 30 mm  
200 Stück 4 x 35 mm

400 Stück 4 x 40 mm

200 Stück 4 x 45 mm  
200 Stück 4 x 50 mm



Komplett im Sortimentskoffer mit Einteilung

Sortimo-Koffer finden Sie im Werkzeugkatalog auf Seite W 12.



## ED TS-Spezial-Spanplattenschrauben mit **kleinem Kopf 5,5 mm Ø**

gleitbeschichtet

Senkkopf mit PZ 1,

für Teppichschienen, Raffhaken, Gardinenschienen usw.



vermessingt

116540 AV 4,0 x 40 mm

116545 AV 4,0 x 45 mm

500 Stück  
500 Stück

brüniert

116640 AV 4,0 x 40 mm

500 Stück

vernickelt

116735 AV 4,0 x 35 mm

116740 AV 4,0 x 40 mm

116745 AV 4,0 x 45 mm

500 Stück  
500 Stück  
500 Stück

Edelstahl rostfrei

130866 AV 3,0 x 25 mm



100 Stück

Art.-Nr. Artikel-Bezeichnung VE



## Spanplattenschrauben TORX

gleitbeschichtet,  
verzinkt



Art.-Nr.	Artikel-Bezeichnung	VE
	Senkkopf mit T20	
116603	4,0 x 20 mm <b>Vollgewinde</b>	200 Stück
116605	4,0 x 30 mm <b>Vollgewinde</b>	200 Stück
116607	4,0 x 40 mm <b>Vollgewinde</b>	200 Stück
116608	4,0 x 45 mm <b>Teilgewinde</b>	100 Stück
116609	4,0 x 50 mm <b>Vollgewinde</b>	200 Stück
116610	4,0 x 60 mm <b>Teilgewinde</b>	200 Stück
116611	4,0 x 70 mm <b>Teilgewinde</b>	200 Stück
116706	4,5 x 40 mm <b>Vollgewinde</b>	200 Stück
116707	4,5 x 45 mm <b>Teilgewinde</b>	200 Stück

	Senkkopf mit T25	
116708	4,5 x 50 mm <b>Vollgewinde</b>	200 Stück
116710	4,5 x 60 mm <b>Teilgewinde</b>	200 Stück
116711	4,5 x 70 mm <b>Teilgewinde</b>	100 Stück
116712	4,5 x 80 mm <b>Teilgewinde</b>	100 Stück



## Edelstahl - Spanplattenschrauben TORX

gleitbeschichtet



Art.-Nr.	Artikel-Bezeichnung	VE
	Senkkopf mit T20	
116613 <small>AV</small>	4,0 x 30 mm <b>Teilgewinde</b>	200 Stück
116614 <small>AV</small>	4,0 x 35 mm <b>Teilgewinde</b>	200 Stück
116615 <small>AV</small>	4,0 x 40 mm <b>Teilgewinde</b>	200 Stück
116616 <small>AV</small>	4,0 x 45 mm <b>Teilgewinde</b>	200 Stück
116617 <small>AV</small>	4,0 x 50 mm <b>Teilgewinde</b>	200 Stück

	Senkkopf mit T25	
116619	4,5 x 40 mm <b>Teilgewinde</b>	200 Stück
116620	4,5 x 45 mm <b>Teilgewinde</b>	200 Stück
116621	4,5 x 50 mm <b>Teilgewinde</b>	200 Stück
116622	4,5 x 60 mm <b>Teilgewinde</b>	200 Stück



## Schnellbauschrauben

Kreuzschlitz, Trompetenkopf,  
phosphatiert



116100 <small>AV</small>	3,9 x 25 mm	200 Stück
116101 <small>AV</small>	3,9 x 35 mm	200 Stück
116102	3,9 x 45 mm	200 Stück
116103	3,9 x 55 mm	200 Stück
116104	4,2 x 65 mm	250 Stück
116105	4,2 x 75 mm	250 Stück



## Drill-Selbstbohrschrauben

Bohren selbständig durch Bleche,  
verzinkt



Art.-Nr.	Artikel-Bezeichnung	VE
	Linsenkopf	
116407	2,9 x 13 mm	100 Stück
116405	3,9 x 25 mm	100 Stück
116406	3,9 x 32 mm	100 Stück

	Senkkopf	<b>Weitere Größen auf Anfrage!</b>	
116402	3,9 x 16 mm		100 Stück
116504	3,5 x 19 mm		100 Stück
116505	3,9 x 25 mm		100 Stück
116506	3,9 x 32 mm		100 Stück
116507	3,9 x 38 mm		100 Stück

## § 1 Geltung

(1) Alle Lieferungen, Leistungen und Angebote des Verkäufers erfolgen ausschließlich aufgrund dieser Allgemeinen Lieferbedingungen. Diese sind Bestandteil aller Verträge, die der Verkäufer mit seinen Vertragspartnern (nachfolgend auch „Auftraggeber“ genannt) über die von ihm angebotenen Lieferungen oder Leistungen schließt. Sie gelten auch für alle zukünftigen Lieferungen, Leistungen oder Angebote an den Auftraggeber, selbst wenn sie nicht nochmals gesondert vereinbart werden.

(2) Geschäftsbedingungen des Auftraggebers oder Dritter finden keine Anwendung, auch wenn der Verkäufer ihrer Geltung im Einzelfall nicht gesondert widerspricht. Selbst wenn der Verkäufer auf ein Schreiben Bezug nimmt, das Geschäftsbedingungen des Auftraggebers oder eines Dritten enthält oder auf solche verweist, liegt darin kein Einverständnis mit der Geltung jener Geschäftsbedingungen.

## § 2 Angebot und Vertragsabschluss

(1) Alle Angebote des Verkäufers sind freibleibend und unverbindlich, sofern sie nicht ausdrücklich als verbindlich gekennzeichnet sind. Bestellungen oder Aufträge kann der Verkäufer innerhalb von vierzehn Tagen nach Zugang annehmen. Dabei beträgt der Mindestbestellwert 30 Euro.

(2) Allein maßgeblich für die Rechtsbeziehungen zwischen Verkäufer und Auftraggeber ist der schriftlich oder ggf. fernmündlich geschlossene Kaufvertrag, einschließlich dieser Allgemeinen Lieferbedingungen. Dieser gibt alle Abreden zwischen den Vertragsparteien zum Vertragsgegenstand vollständig wieder. Mündliche Zusagen des Verkäufers vor Abschluss dieses Vertrages sind rechtlich unverbindlich und mündliche Abreden der Vertragsparteien werden durch den schriftlichen Vertrag ersetzt, sofern sich nicht jeweils ausdrücklich aus ihnen ergibt, dass sie verbindlich fortgelten.

(3) Ergänzungen und Abänderungen der getroffenen Vereinbarungen einschließlich dieser Allgemeinen Lieferbedingungen bedürfen zu ihrer Wirksamkeit der Schriftform. Mit Ausnahme von Geschäftsführern oder Prokuristen sind die Mitarbeiter des Verkäufers nicht berechtigt, hiervon abweichende mündliche Abreden zu treffen. Zur Wahrung der Schriftform genügt die telekommunikative Übermittlung, insbesondere per Telefax oder per E-Mail, sofern die Kopie der unterschriebenen Erklärung übermittelt wird.

(4) Angaben des Verkäufers zum Gegenstand der Lieferung oder Leistung (z.B. Gewichte, Maße, Gebrauchswerte, Belastbarkeit, Toleranzen und technische Daten) sowie unsere Darstellungen desselben (z.B. Zeichnungen und Abbildungen) sind nur annähernd maßgeblich, soweit nicht die Verwendbarkeit zum vertraglich vorgesehenen Zweck eine genaue Übereinstimmung voraussetzt. Sie sind keine garantierten Beschaffenheitsmerkmale, sondern Beschreibungen oder Kennzeichnungen der Lieferung oder Leistung. Handelsübliche Abweichungen und Abweichungen, die aufgrund rechtlicher Vorschriften erfolgen oder technische Verbesserungen darstellen, sowie die Ersetzung von Bauteilen durch gleichwertige Teile sind zulässig, soweit sie die Verwendbarkeit zum vertraglich vorgesehenen Zweck nicht beeinträchtigen.

(5) Der Verkäufer behält sich das Eigentum oder Urheberrecht an allen von ihm abgegebenen Angeboten und Kostenvoranschlägen sowie dem Auftraggeber zur Verfügung gestellten Zeichnungen, Abbildungen, Berechnungen, Prospekten, Katalogen, Modellen, Werkzeugen und anderen Unterlagen und Hilfsmitteln vor. Der Auftraggeber darf diese Gegenstände ohne ausdrückliche Zustimmung des Verkäufers weder als solche noch inhaltlich Dritten zugänglich machen, sie bekannt geben, selbst oder durch Dritte nutzen oder vervielfältigen. Er hat auf Verlangen des Verkäufers diese Gegenstände vollständig an diesen zurückzugeben und eventuell gefertigte Kopien zu vernichten, wenn sie von ihm im ordnungsgemäßen Geschäftsgang nicht mehr benötigt werden oder wenn Verhandlungen nicht zum Abschluss eines Vertrages führen.

## § 3 Preise und Zahlung

(1) Die Preise gelten für den in den Auftragsbestätigungen aufgeführten Leistungs- und Lieferungsumfang. Mehr- oder Sonderleistungen werden gesondert berechnet. Die Preise verstehen sich in EURO ab Werk zuzüglich Verpackung, Versand gemäß den aktuell gültigen und auf unserer Website einsehbaren Versandkosten, der gesetzlichen Mehrwertsteuer, bei Exportlieferungen Zoll sowie Gebühren und anderer öffentlicher Abgaben.

(2) Soweit den vereinbarten Preisen die Listenpreise des Verkäufers zugrunde liegen und die Lieferung erst mehr als vier Monate nach Vertragsschluss erfolgen soll, gelten die bei Lieferung gültigen Listenpreise des Verkäufers (jeweils abzüglich eines vereinbarten prozentualen oder festen Rabatts).

(3) Rechnungsbeträge sind innerhalb von 10 Tagen mit 3% Skonto oder innerhalb dreißig Tagen ohne jeden Abzug zu bezahlen, sofern nicht etwas anderes schriftlich vereinbart ist. Reparaturen sind sofort und ohne jeden Abzug zahlbar. Maßgebend für das Datum der Zahlung ist der Eingang des Rechnungsbetrages beim Verkäufer.

Schecks gelten erst nach Einlösung als Zahlung. Wechsel werden nur erfüllungshalber entgegengenommen. Leistet der Auftraggeber bei Fälligkeit nicht, so sind die ausstehenden Beträge ab dem Tag der Fälligkeit mit 7% Zinsen über dem Basiszinssatz p. a. zu verzinsen; die Geltendmachung höherer Zinsen und weiterer Schäden im Falle des Verzugs bleibt unberührt.

(4) Sämtliche Diskont-, Inkasso- und sonstigen Spesen sowie die Wechselsteuer gehen zu Lasten des Auftraggebers und sind sofort nach Aufgabe zu bezahlen.

(5) Kommt der Auftraggeber in Zahlungsverzug, wird ein Scheck oder Wechsel nicht eingelöst, oder werden uns Umstände bekannt, die die Kreditwürdigkeit des Auftraggebers in Frage stellen, ist der Verkäufer berechtigt, sämtliche noch offenen Forderungen fällig zu stellen.

(6) Die Aufrechnung mit Gegenansprüchen des Auftraggebers oder die Zurückbehaltung von Zahlungen wegen solcher Ansprüche ist nur zulässig, soweit die Gegenansprüche unbestritten oder rechtskräftig festgestellt sind.

(7) Soweit bei Neukunden keine Referenzen vorliegen, liefert der Verkäufer nur gegen Vorauszahlung oder Nachnahme.

(8) Der Verkäufer ist berechtigt, noch ausstehende Lieferungen oder Leistungen nur gegen Vorauszahlung oder Sicherheitsleistung auszuführen oder zu erbringen, wenn ihm nach Abschluss des Vertrages Umstände bekannt werden, welche die Kreditwürdigkeit des Auftraggebers wesentlich zu mindern geeignet sind und durch welche die Bezahlung der offenen Forderungen des Verkäufers durch den Auftraggeber aus dem jeweiligen Vertragsverhältnis (einschließlich aus anderen Einzelaufträgen, für die dieselben Bedingungen gelten) gefährdet wird. Der Verkäufer ist überdies berechtigt, ganz oder teilweise von noch laufenden Verträgen Abstand zu nehmen.

## § 4 Lieferung und Lieferzeit

(1) Lieferungen erfolgen ab Werk.

(2) Vom Verkäufer in Aussicht gestellte Fristen und Termine für Lieferungen und Leistungen gelten stets nur annähernd, es sei denn, dass ausdrücklich eine feste Frist oder ein fester Termin zugesagt oder vereinbart ist. Sofern Versendung vereinbart wurde, beziehen sich Lieferfristen und Liefertermine auf den Zeitpunkt der Übergabe an den Spediteur, Frachtführer oder sonst mit dem Transport beauftragten Dritten.

(3) Der Verkäufer kann – unbeschadet seiner Rechte aus Verzug des Auftraggebers – vom Auftraggeber eine Verlängerung von Liefer- und Leistungsfristen oder eine Verschiebung von Liefer- und Leistungsterminen um den Zeitraum verlangen, in dem der Auftraggeber seinen vertraglichen Verpflichtungen dem Verkäufer gegenüber nicht nachkommt.

(4) Der Verkäufer haftet nicht für Unmöglichkeit der Lieferung oder für Lieferverzögerungen, soweit diese durch höhere Gewalt oder sonstige, zum Zeitpunkt des Vertragsabschlusses nicht vorhersehbare Ereignisse (z.B. Betriebsstörungen aller Art, Schwierigkeiten in der Material- oder Energiebeschaffung, Transportverzögerungen, Streiks, rechtmäßige Aussperrungen, Mangel an Arbeitskräften, Energie oder Rohstoffen, Schwierigkeiten bei der Beschaffung von notwendigen behördlichen Genehmigungen, behördliche Maßnahmen oder die ausbleibende, nicht richtige oder nicht rechtzeitige Belieferung durch Lieferanten) verursacht worden sind, die der Verkäufer nicht zu vertreten hat. Sofern solche Ereignisse dem Verkäufer die Lieferung oder Leistung wesentlich erschweren oder unmöglich machen und die Behinderung nicht nur von vorübergehender Dauer ist, ist der Verkäufer zum Rücktritt vom Vertrag berechtigt. Bei Hindernissen vorübergehender Dauer verlängern sich die Liefer- oder Leistungsfristen oder verschieben sich die Liefer- oder Leistungstermine um den Zeitraum der Behinderung zuzüglich einer angemessenen Anlaufzeit. Soweit dem Auftraggeber infolge der Verzögerung die Abnahme der Lieferung oder Leistung nicht zuzumuten ist, kann er durch unverzügliche schriftliche Erklärung gegenüber dem Verkäufer vom Vertrag zurücktreten.

(5) Der Verkäufer ist nur zu Teillieferungen berechtigt, wenn

- die Teillieferung für den Auftraggeber im Rahmen des vertraglichen Bestimmungszwecks verwendbar ist,
- die Lieferung der restlichen bestellten Ware sichergestellt ist und
- dem Auftraggeber hierdurch kein erheblicher Mehraufwand oder zusätzliche Kosten entstehen (es sei denn, der Verkäufer erklärt sich zur Übernahme dieser Kosten bereit).

(6) Gerät der Verkäufer mit einer Lieferung oder Leistung in Verzug oder wird ihm eine Lieferung oder Leistung, gleich aus welchem Grunde, unmöglich, so ist die Haftung des Verkäufers auf Schadensersatz nach Maßgabe des § 9 dieser Allgemeinen Lieferbedingungen beschränkt.

## **§ 5 Erfüllungsort, Versand, Verpackung, Gefahrübergang, Abnahme**

(1) Erfüllungsort für alle Verpflichtungen aus dem Vertragsverhältnis ist Altena, soweit nichts anderes bestimmt ist. Schuldet der Verkäufer auch die Installation, ist Erfüllungsort der Ort, an dem die Installation zu erfolgen hat.

(2) Die Versandart und die Verpackung unterstehen dem pflichtgemäßen Ermessen des Verkäufers. Wird vom Auftraggeber eine andere Versandart gewünscht, so gehen die Mehrkosten zu seinen Lasten, auch bei vereinbarter frachtfreier Lieferung.

(3) Die Gefahr geht spätestens mit der Übergabe des Liefergegenstandes (wobei der Beginn des Verladevorgangs maßgeblich ist) an den Spediteur, Frachtführer oder sonst zur Ausführung der Versendung bestimmten Dritten auf den Auftraggeber über. Dies gilt auch dann, wenn Teillieferungen erfolgen oder der Verkäufer noch andere Leistungen (z.B. Versand oder Installation) übernommen hat. Verzögert sich der Versand oder die Übergabe infolge eines Umstandes, dessen Ursache beim Auftraggeber liegt, geht die Gefahr von dem Tag an auf den Auftraggeber über, an dem der Liefergegenstand versandbereit ist und der Verkäufer dies dem Auftraggeber angezeigt hat.

(4) Lagerkosten nach Gefahrübergang trägt der Auftraggeber. Bei Lagerung durch den Verkäufer betragen die Lagerkosten 0,25% des Rechnungsbetrages der zu lagernden Liefergegenstände pro abgelaufene Woche. Die Geltendmachung und der Nachweis weiterer oder geringerer Lagerkosten bleiben vorbehalten.

(5) Die Warensendung ist gemäß der Bedingungen des jeweiligen Versandunternehmens versichert, die der Auftraggeber beim Verkäufer im Einzelfall erfragen kann. Ansonsten wird die Sendung vom Verkäufer nur auf ausdrücklichen Wunsch des Auftraggebers und auf seine Kosten gegen Diebstahl, Bruch-, Transport-, Feuer- und Wasserschäden oder sonstige versicherbare Risiken versichert.

(6) Soweit eine Abnahme stattzufinden hat, gilt die Kaufsache als abgenommen, wenn

- die Lieferung und, sofern der Verkäufer auch die Installation schuldet, die Installation abgeschlossen ist,
- der Verkäufer dies dem Auftraggeber unter Hinweis auf die Abnahmefiktion nach diesem § 5 (6) mitgeteilt und ihn zur Abnahme aufgefordert hat,
- seit der Lieferung oder Installation zwölf Werkzeuge vergangen sind oder der Auftraggeber mit der Nutzung der Kaufsache begonnen hat (z.B. die gelieferte Anlage in Betrieb genommen hat) und in diesem Fall seit Lieferung oder Installation sechs Werkzeuge vergangen sind und
- der Auftraggeber die Abnahme innerhalb dieses Zeitraums aus einem anderen Grund als wegen eines dem Verkäufer angezeigten Mangels, der die Nutzung der Kaufsache unmöglich macht oder wesentlich beeinträchtigt, unterlassen hat.

## **§ 6 Gewährleistung, Sachmängel**

(1) Der Verkäufer gibt die Gewährleistungs- und Garantiezusagen der Hersteller der von ihm verkauften Produkte, soweit vorhanden, zu Gunsten des Auftraggebers an den Auftraggeber weiter.

(2) Wenn Gewährleistungs- oder Garantiezusagen des Herstellers nicht existieren, beträgt die Gewährleistungsfrist ein Jahr ab Lieferung oder, soweit eine Abnahme erforderlich ist, ab der Abnahme. Im Übrigen gelten die Abs. 3 bis 9 dieses § 6.

(3) Die gelieferten Gegenstände sind unverzüglich nach Ablieferung an den Auftraggeber oder an den von ihm bestimmten Dritten sorgfältig zu untersuchen. Sie gelten hinsichtlich offensichtlicher Mängel oder anderer Mängel, die bei einer unverzüglichen, sorgfältigen Untersuchung erkennbar gewesen wären, als vom Auftraggeber genehmigt, wenn dem Verkäufer nicht binnen sieben Werktagen nach Ablieferung eine schriftliche Mängelrüge zugeht. Offensichtliche Schäden müssen sofort vom Transportunternehmen bestätigt werden. Solche Schäden sind dem Verkäufer nach Warenempfang innerhalb von 24 Stunden per Telefon oder Fax anzuzeigen.

(4) Hinsichtlich anderer Mängel gelten die Liefergegenstände als vom Auftraggeber genehmigt, wenn die Mängelrüge dem Verkäufer nicht binnen sieben Werktagen nach dem Zeitpunkt zugeht, in dem sich der Mangel zeigte; war der Mangel für den Auftraggeber bei normaler Verwendung bereits zu einem früheren Zeitpunkt erkennbar, ist jedoch dieser frühere Zeitpunkt für den Beginn der Rügefrist maßgeblich. Auf Verlangen des Verkäufers ist



ein beanstandeter Liefergegenstand frachtfrei unter Angabe von Rechnungsdatum und Rechnungsnummer an den Verkäufer zurückzusenden. Bei berechtigter Mängelrüge vergütet der Verkäufer die Kosten des günstigsten Versandweges; dies gilt nicht, soweit die Kosten sich erhöhen, weil der Liefergegenstand sich an einem anderen Ort als dem Ort des bestimmungsgemäßen Gebrauchs befindet.

(5) Bei Sachmängeln der gelieferten Gegenstände ist der Verkäufer nach seiner innerhalb angemessener Frist zu treffenden Wahl zunächst zur Nachbesserung oder Ersatzlieferung verpflichtet und berechtigt. Im Falle des Fehlschlagens, d.h. der Unmöglichkeit, Unzumutbarkeit, Verweigerung oder unangemessenen Verzögerung der Nachbesserung oder Ersatzlieferung, kann der Auftraggeber vom Vertrag zurücktreten oder den Kaufpreis angemessen mindern.

(6) Beruht ein Mangel auf dem Verschulden des Verkäufers, kann der Auftraggeber unter den in § 9 bestimmten Voraussetzungen Schadensersatz verlangen.

(7) Bei Mängeln von Bauteilen anderer Hersteller, die der Verkäufer aus lizenzrechtlichen oder tatsächlichen Gründen nicht beseitigen kann, wird der Verkäufer nach seiner Wahl seine Gewährleistungsansprüche gegen die Hersteller und Lieferanten für Rechnung des Auftraggebers geltend machen oder an den Auftraggeber abtreten. Gewährleistungsansprüche gegen den Verkäufer bestehen bei derartigen Mängeln unter den sonstigen Voraussetzungen und nach Maßgabe dieser Allgemeinen Lieferbedingungen nur, wenn die gerichtliche Durchsetzung der vorstehend genannten Ansprüche gegen den Hersteller und Lieferanten erfolglos war oder, beispielsweise aufgrund einer Insolvenz, aussichtslos ist. Während der Dauer des Rechtsstreits ist die Verjährung der betreffenden Gewährleistungsansprüche des Auftraggebers gegen den Verkäufer gehemmt.

(8) Die Gewährleistung entfällt, wenn der Auftraggeber ohne Zustimmung des Verkäufers den Liefergegenstand ändert oder durch Dritte ändern lässt und die Mängelbeseitigung hierdurch unmöglich oder unzumutbar erschwert wird. In jedem Fall hat der Auftraggeber die durch die Änderung entstehenden Mehrkosten der Mängelbeseitigung zu tragen.

(9) Eine im Einzelfall mit dem Auftraggeber vereinbarte Lieferung gebrauchter Gegenstände erfolgt unter Ausschluss jeglicher Gewährleistung für Sachmängel.

## § 7 Warenrücknahme

(1) Warenrücknahme erfolgt nur nach ausdrücklicher Genehmigung durch den Verkäufer unter Angabe von Rechnungsdatum und Rechnungsnummer. Sonderanfertigungen und Zuschnitte sind von der Rücknahme ausgeschlossen.

Die Rücksendung ist in jedem Falle frei Haus vorzunehmen. Bei unfreier Rücksendung wird die Annahme durch den Verkäufer verweigert.

(2) Bei nicht vom Verkäufer verschuldeten Retouren muss dieser einen Bearbeitungsabschlag berechnen. Angefallene Versandkosten sind in diesem Fall vom Auftraggeber zu tragen. Es werden im Einzelfall vom gutzuschreibenden Warenwert 15%, mindestens aber 20,- EUR abgezogen.

## § 8 Schutzrechte

(1) Der Verkäufer steht nach Maßgabe dieses § 8 dafür ein, dass der Liefergegenstand frei von gewerblichen Schutzrechten oder Urheberrechten Dritter ist. Jeder Vertragspartner wird den anderen Vertragspartner unverzüglich schriftlich benachrichtigen, falls ihm gegenüber Ansprüche wegen der Verletzung solcher Rechte geltend gemacht werden.

(2) In dem Fall, dass der Liefergegenstand ein gewerbliches Schutzrecht oder Urheberrecht eines Dritten verletzt, wird der Verkäufer nach seiner Wahl und auf seine Kosten den Liefergegenstand derart abändern oder austauschen, dass keine Rechte Dritter mehr verletzt werden, der Liefergegenstand aber weiterhin die vertraglich vereinbarten Funktionen erfüllt, oder dem Auftraggeber durch Abschluss eines Lizenzvertrages das Nutzungsrecht verschaffen. Gelingt ihm dies innerhalb eines angemessenen Zeitraums nicht, ist der Auftraggeber berechtigt, von dem Vertrag zurückzutreten oder den Kaufpreis angemessen zu mindern. Etwaige Schadensersatzansprüche des Auftraggebers unterliegen den Beschränkungen des § 9 dieser Allgemeinen Lieferbedingungen.

(3) Bei Rechtsverletzungen durch vom Verkäufer gelieferte Produkte anderer Hersteller wird der Verkäufer nach seiner Wahl seine Ansprüche gegen die Hersteller und Vorlieferanten für Rechnung des Auftraggebers geltend machen oder an den Auftraggeber abtreten. Ansprüche gegen den Verkäufer bestehen in diesen Fällen nach Maßgabe dieses § 8 nur, wenn die gerichtliche Durchsetzung der vorstehend genannten Ansprüche gegen die Hersteller und Vorlieferanten erfolglos war oder, beispielsweise aufgrund einer Insolvenz, aussichtslos ist.

## § 9 Haftung auf Schadensersatz wegen Verschuldens

(1) Die Haftung des Verkäufers auf Schadensersatz, gleich aus welchem Rechtsgrund, insbesondere aus Unmöglichkeit, Verzug, mangelhafter oder falscher Lieferung, Vertragsverletzung, Verletzung von Pflichten bei Vertragsverhandlungen und unerlaubter Handlung ist, soweit es dabei jeweils auf ein Verschulden ankommt, nach Maßgabe dieses § 9 eingeschränkt.

(2) Der Verkäufer haftet nicht im Falle einfacher Fahrlässigkeit seiner Organe, gesetzlichen Vertreter, Angestellten oder sonstigen Erfüllungsgehilfen, soweit es sich nicht um eine Verletzung vertragswesentlicher Pflichten handelt. Vertragswesentlich sind die Verpflichtung zur rechtzeitigen Lieferung und Installation des Liefergegenstands, dessen Freiheit von Mängeln, die seine Funktionsfähigkeit oder Gebrauchstauglichkeit mehr als nur unerheblich beeinträchtigen, sowie Beratungs-, Schutz- und Obhutspflichten, die dem Auftraggeber die vertragsgemäße Verwendung des Liefergegenstands ermöglichen sollen oder den Schutz von Leib oder Leben von Personal des Auftraggebers oder den Schutz von dessen Eigentum vor erheblichen Schäden bezwecken.

(3) Soweit der Verkäufer gemäß § 9 (2) dem Grunde nach auf Schadensersatz haftet, ist diese Haftung auf Schäden begrenzt, die der Verkäufer bei Vertragsschluss als mögliche Folge einer Vertragsverletzung vorausgesehen hat oder die er bei Anwendung verkehrsüblicher Sorgfalt hätte voraussehen müssen. Mittelbare Schäden und Folgeschäden, die Folge von Mängeln des Liefergegenstands sind, sind außerdem nur ersatzfähig, soweit solche Schäden bei bestimmungsgemäßer Verwendung des Liefergegenstands typischerweise zu erwarten sind.

(4) Im Falle einer Haftung für einfache Fahrlässigkeit ist die Ersatzpflicht des Verkäufers für Sachschäden und daraus resultierende weitere Vermögensschäden auf 150% des Nettofakturenwertes je Schadensfall beschränkt, auch wenn es sich um eine Verletzung vertragswesentlicher Pflichten handelt.

(5) Die vorstehenden Haftungsausschlüsse und -beschränkungen gelten in gleichem Umfang zugunsten der Organe, gesetzlichen Vertreter, Angestellten und sonstigen Erfüllungsgehilfen des Verkäufers.

(6) Soweit der Verkäufer technische Auskünfte gibt oder beratend tätig wird und diese Auskünfte oder Beratung nicht zu dem von ihm geschuldeten, vertraglich vereinbarten Leistungsumfang gehören, geschieht dies unentgeltlich und unter Ausschluss jeglicher Haftung.

(7) Die Einschränkungen dieses § 9 gelten nicht für die Haftung des Verkäufers wegen vorsätzlichen Verhaltens, für garantierte Beschaffenheitsmerkmale, wegen Verletzung des Lebens, des Körpers oder der Gesundheit oder nach dem Produkthaftungsgesetz.

## § 10 Eigentumsvorbehalt

- (1) Der nachfolgend vereinbarte Eigentumsvorbehalt dient der Sicherung aller jeweils bestehenden derzeitigen und künftigen Forderungen des Verkäufers gegen den Auftraggeber aus der zwischen den Vertragspartnern bestehenden Lieferbeziehung (einschließlich Saldoforderungen aus einem auf diese Lieferbeziehung beschränkten Kontokorrentverhältnis).
- (2) Die vom Verkäufer an den Auftraggeber gelieferte Ware bleibt bis zur vollständigen Bezahlung aller gesicherten Forderungen – bei Bezahlung durch Scheck oder Wechsel bis zu deren Einlösung - Eigentum des Verkäufers. Die Ware sowie die nach den nachfolgenden Bestimmungen an ihre Stelle tretende, vom Eigentumsvorbehalt erfasste Ware wird nachfolgend „Vorbehaltsware“ genannt.
- (3) Der Auftraggeber verwahrt die Vorbehaltsware unentgeltlich für den Verkäufer.
- (4) Der Auftraggeber ist berechtigt, die Vorbehaltsware bis zum Eintritt des Verwertungsfalls (Absatz 9) im ordnungsgemäßen Geschäftsverkehr zu verarbeiten und zu veräußern. Verpfändungen und Sicherungsübereignungen sind unzulässig.
- (5) Wird die Vorbehaltsware vom Auftraggeber verarbeitet, so wird vereinbart, dass die Verarbeitung im Namen und für Rechnung des Verkäufers als Hersteller erfolgt und der Verkäufer unmittelbar das Eigentum oder – wenn die Verarbeitung aus Stoffen mehrerer Eigentümer erfolgt oder der Wert der verarbeiteten Sache höher ist als der Wert der Vorbehaltsware – das Miteigentum (Bruchteileigentum) an der neu geschaffenen Sache im Verhältnis des Werts der Vorbehaltsware zum Wert der neu geschaffenen Sache erwirbt. Für den Fall, dass kein solcher Eigentumserwerb beim Verkäufer eintreten sollte, überträgt der Auftraggeber bereits jetzt sein künftiges Eigentum oder – im o.g. Verhältnis – Miteigentum an der neu geschaffenen Sache zur Sicherheit an den Verkäufer. Wird die Vorbehaltsware mit anderen Sachen zu einer einheitlichen Sache verbunden oder untrennbar vermischt und ist eine der anderen Sachen als Hauptsache anzusehen, so überträgt der Verkäufer, soweit die Hauptsache ihm gehört, dem Auftraggeber anteilig das Miteigentum an der einheitlichen Sache in dem in Satz 1 genannten Verhältnis.
- (6) Im Fall der Weiterveräußerung der Vorbehaltsware tritt der Auftraggeber bereits jetzt sicherungshalber die hieraus entstehende Forderung gegen den Erwerber – bei Miteigentum des Verkäufers an der Vorbehaltsware anteilig entsprechend dem Miteigentumsanteil – an den Verkäufer ab. Gleiches gilt für sonstige Forderungen, die an die Stelle der Vorbehaltsware treten oder sonst hinsichtlich der Vorbehaltsware entstehen, wie z.B. Versicherungsansprüche oder Ansprüche aus unerlaubter Handlung bei Verlust oder Zerstörung. Der Verkäufer ermächtigt den Auftraggeber widerruflich, die an den Verkäufer abgetretenen Forderungen im eigenen Namen einzuziehen. Der Verkäufer darf diese Einzugsermächtigung nur im Verwertungsfall widerrufen.
- (7) Greifen Dritte auf die Vorbehaltsware zu, insbesondere durch Pfändung, wird der Auftraggeber sie unverzüglich auf das Eigentum des Verkäufers hinweisen und den Verkäufer hierüber informieren, um ihm die Durchsetzung seiner Eigentumsrechte zu ermöglichen. Sofern der Dritte nicht in der Lage ist, dem Verkäufer die in diesem Zusammenhang entstehenden gerichtlichen oder außergerichtlichen Kosten zu erstatten, haftet hierfür der Auftraggeber dem Verkäufer.
- (8) Der Verkäufer wird die Vorbehaltsware sowie die an ihre Stelle tretenden Sachen oder Forderungen freigeben, soweit ihr Wert die Höhe der gesicherten Forderungen um mehr als 50 % übersteigt. Die Auswahl der danach freizugebenden Gegenstände liegt beim Verkäufer.
- (9) Tritt der Verkäufer bei vertragswidrigem Verhalten des Auftraggeber – insbesondere Zahlungsverzug – vom Vertrag zurück (Verwertungsfall), ist er berechtigt, die Vorbehaltsware herauszuverlangen.

## § 11 Schlussbestimmungen

- (1) Ist der Auftraggeber Kaufmann, eine juristische Person des öffentlichen Rechts oder ein öffentlich-rechtliches Sondervermögen oder hat er in der Bundesrepublik Deutschland keinen allgemeinen Gerichtsstand, so ist Gerichtsstand für alle etwaigen Streitigkeiten aus der Geschäftsbeziehung zwischen dem Verkäufer und dem Auftraggeber nach Wahl des Verkäufers Altena oder der Sitz des Auftraggebers. Für Klagen gegen den Verkäufer ist in diesen Fällen jedoch Altena ausschließlicher Gerichtsstand. Zwingende gesetzliche Bestimmungen über ausschließliche Gerichtsstände bleiben von dieser Regelung unberührt.
- (2) Die Beziehungen zwischen dem Verkäufer und dem Auftraggeber unterliegen ausschließlich dem Recht der Bundesrepublik Deutschland.
- (3) Soweit der Vertrag oder diese Allgemeinen Lieferbedingungen Regelungslücken enthalten, gelten zur Ausfüllung dieser Lücken diejenigen rechtlich wirksamen Regelungen als vereinbart, welche die Vertragspartner nach den wirtschaftlichen Zielsetzungen des Vertrages und dem Zweck dieser Allgemeinen Lieferbedingungen vereinbart hätten, wenn sie die Regelungslücke gekannt hätten.

## § 12 Datenschutz

- (1) Soweit zur Erfüllung eines Vertrags erforderlich, ist der Verkäufer befugt, die Daten des Kunden gem. Art. 6 Abs. 1 S. 1 lit. b DS-GVO per EDV zu speichern und zu verarbeiten.
- (2) Für den Besuch der Internet-Seiten des Verkäufers gelten die unter folgendem Link: <https://www.ed-altena.de/datenschutz> abrufbaren Datenschutzbestimmungen und rechtlichen Hinweise, auf deren Geltung hiermit ausdrücklich hingewiesen wird.

## Bankverbindung:

Deutschland:	BLZ	Konto-Nr.	IBAN	BIC
Volksbank in Südwestfalen eG	447 615 34	3 000 048 200	DE44447615343000048200	GENODEM1NRD
Postbank Dortmund	440 100 46	195 36-466	DE48440100460019536466	PBNKDEFF
Deutsche Bank Altena	445 700 04	2 068 500	DE44445700040206850000	DEUTDEDW445
Österreich:				
Dornbirner Sparkasse	20602	0000-010025	AT812060200000010025	DOSPAT2DXXX

## Darstellung der Preise im Dekokatalog D.8

---



Die angegebenen Preise sind unverbindliche Verkaufspreise in Euro inkl. MwSt.

Bitte kalkulieren Sie den um ca. 20 bis 25 % höheren Preis für Anbruch oder Zuschnitt selbst mit ein, dieser kann bei aufwändigen Artikeln auch höher sein.

Artikel, bei denen in der Spalte VE das Symbol  (geschlossener Karton) steht, werden in der angegebenen VE geliefert. Ein Anbruch oder Zuschnitt ist nicht vorgesehen.

Artikel mit **AV** am Ende der Art.-Nr. sind nur noch in einer begrenzten Stückzahl verfügbar.

Erklärung der im Katalog D.8 verwendeten Symbole:

 Aufbügelbar

 Flammhemmend